



HENRY PARK PRIMARY SCHOOL
2024 END OF YEAR EXAMINATION
SCIENCE
PRIMARY THREE
BOOKLET A

Name: _____ ()

Class: Primary 3 ()

20 QUESTIONS

40 MARKS

TOTAL TIME FOR BOOKLETS A & B: 1 HOUR 30 MINUTES

INSTRUCTIONS TO CANDIDATES

1. Do not turn over this page until you are told to do so.
2. Follow all instructions carefully.
3. Answer all questions.

Marks for Booklet A: _____ / 40

Parent's Signature: _____

Sections	Marks
A	/ 40
B	/ 40
Total	/ 80

For each question from 1 to 20, four options are given. One of them is the correct answer. Make your choice (1, 2, 3 or 4) and shade your answer on the Optical Answer Sheet.

(40 marks)

1 Study the six objects carefully.

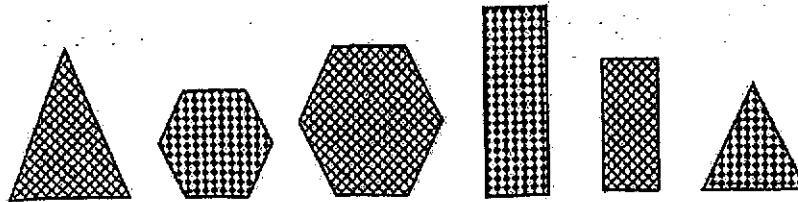

The six objects can be classified according to the following characteristics:

- A shape
- B pattern
- C number of sides

Sarah wants to classify the six objects into two groups only.
Which of the following characteristic(s) should she use?

- (1) A only
- (2) B only
- (3) C only
- (4) A, B and C

()

- 2 Study the pictures of the three animals shown below.

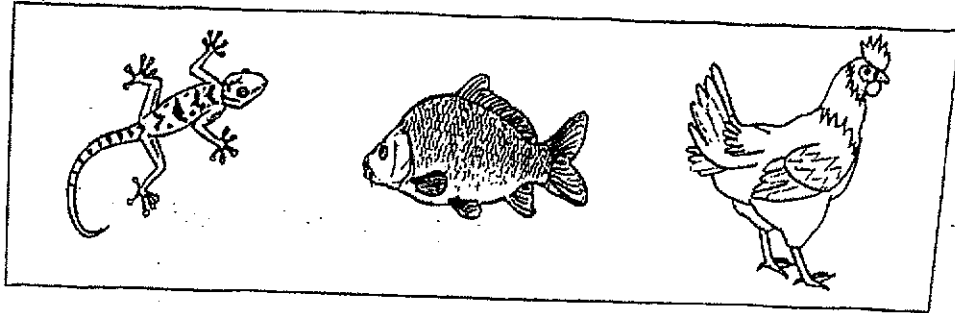

Which of the following characteristics is common among the three animals?

- (1) Their young live in water.
 - (2) They reproduce by laying eggs.
 - (3) They live in both water and on land.
 - (4) They have scales as their outer covering.
- 3 Mrs Lee asked her students to name insects that have a 3-stage life cycle. Four students named the following animals as shown below.

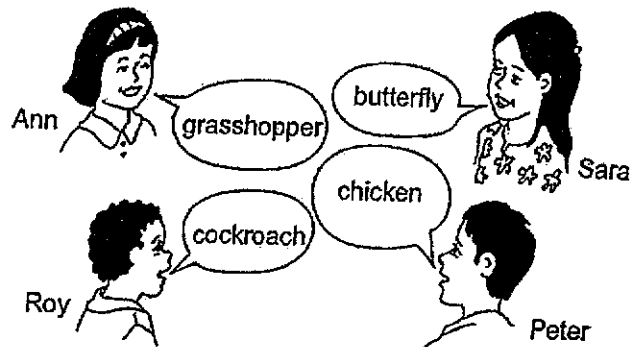

Which students are correct?

- (1) Ann and Roy
- (2) Roy and Sara
- (3) Ann, Roy and Peter
- (4) Ann, Sara and Peter

- 4 The chart shows how some living things are classified.

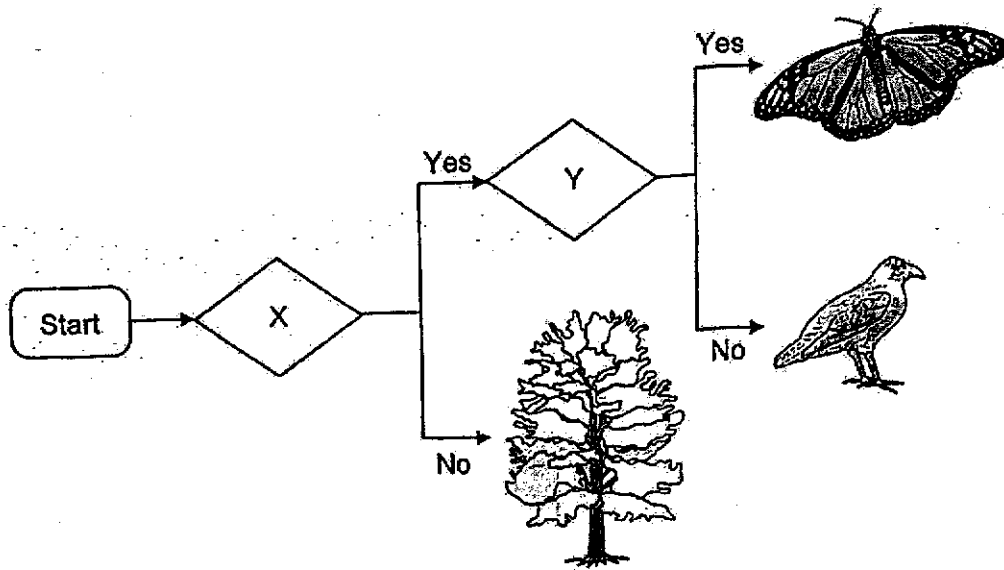

Which of the following represents X and Y?

	X	Y
(1)	able to fly	have feelers
(2)	able to fly	have feathers
(3)	able to reproduce	have six legs
(4)	able to make food	have feelers

()

5 Study the classification chart below.

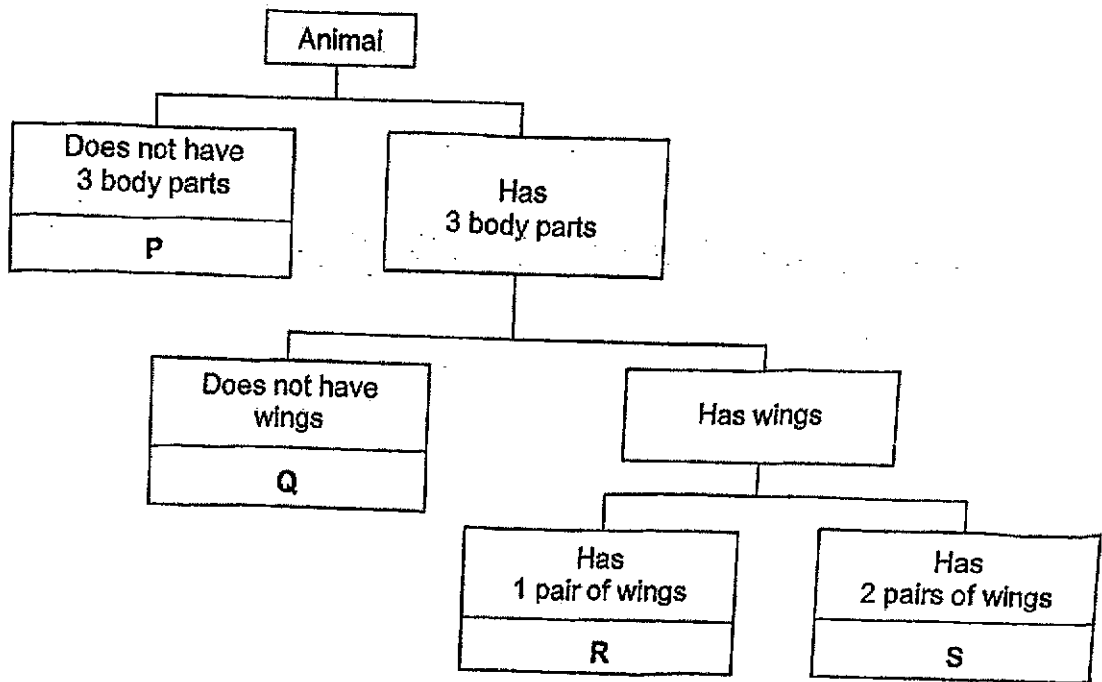

The diagram shows animal X.

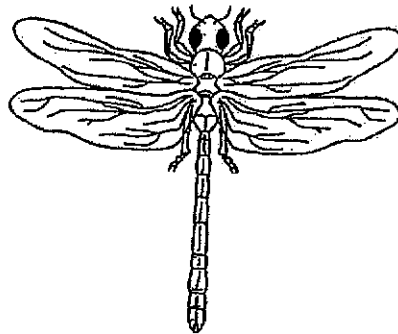

Which group, P, Q, R or S, does animal X belong to?

- (1) P
- (2) Q
- (3) R
- (4) S

()

6 The diagrams show three living things.



Living thing X



Living thing Y



Living thing Z

Based on the diagrams given, which of the following is correct?

		Living things		
Characteristics		X	Y	Z
(1)	Makes its own food		✓	✓
	Reproduces by spores	✓	✓	

		Living things		
Characteristics		X	Y	Z
(2)	Makes its own food	✓	✓	
	Reproduces by spores		✓	✓

		Living things		
Characteristics		X	Y	Z
(3)	Makes its own food		✓	✓
	Reproduces by spores	✓		✓

		Living things		
Characteristics		X	Y	Z
(4)	Makes its own food	✓		✓
	Reproduces by spores		✓	✓

Key - A tick (✓) shows the characteristic is observed

- 7 The diagram shows the Venus flytrap, a plant that traps insects.

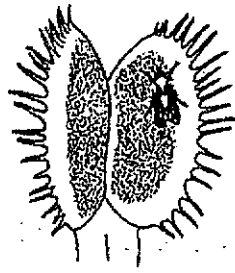

a fly lands on the leaf



the leaves close

Which one of the following characteristics of living things does the Venus flytrap show when the leaves close?

- (1) Living things grow.
- (2) Living things respond.
- (3) Living things reproduce.
- (4) Living things need air, water and food.

()

- 8 Amanda wanted to know whether plants need water to grow. She used two similar plants, P and Q, for her experiment. She placed both plants in her garden, but watered only plant P.

At the start of the experiment

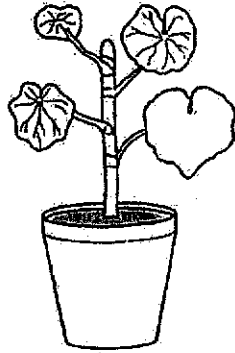

Plant P

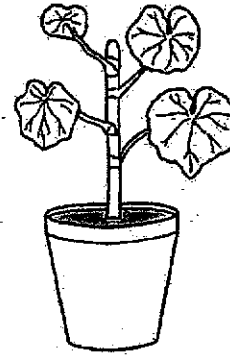

Plant Q

After 6 days

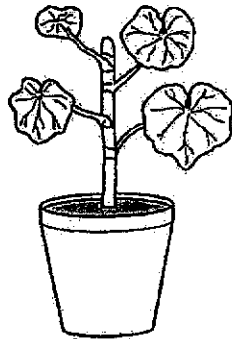

Plant P

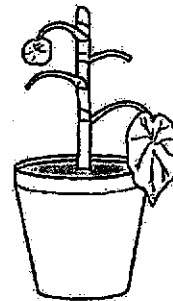

Plant Q

After six days, Amanda can infer that plants _____.

- (1) need air to live
- (2) plants need water to grow
- (3) grew better in the sunlight
- (4) plants need air and food to grow

()

9 The diagram shows the life cycle of a mosquito.

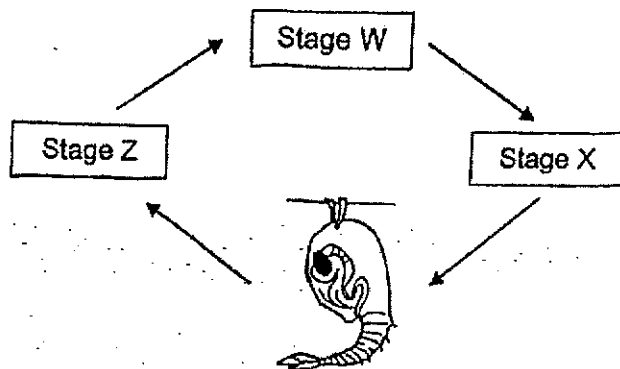

What are stages W, X and Z?

Stages		
W	X	Z
(1) egg	larva	adult
(2) egg	pupa	adult
(3) adult	pupa	egg
(4) adult	larva	egg

()

10 Which of the following shows the life cycle of a flowering plant?

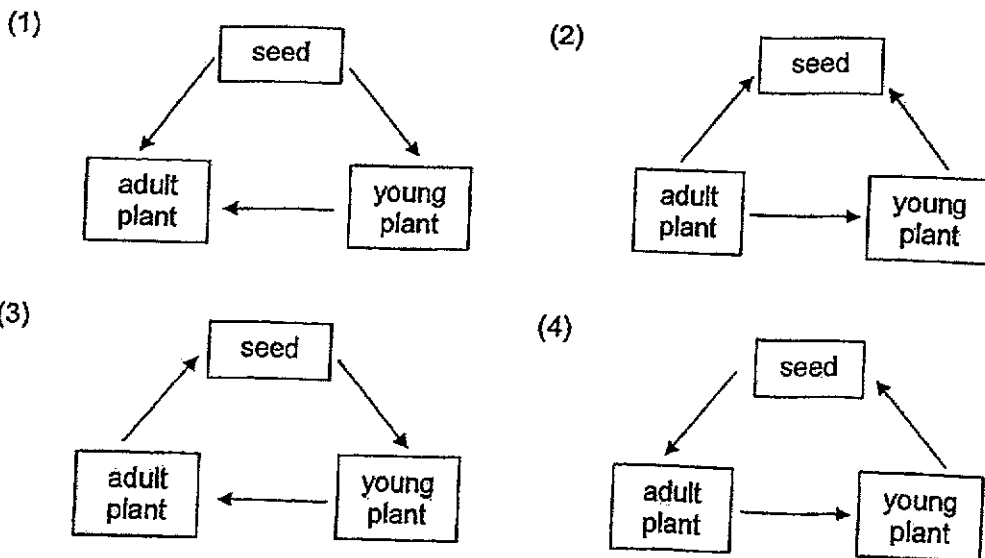

()

- 11 Mandy wants to find out if animal Z, shown below, is an amphibian.



Which one of the following ways would help Mandy confirm if animal Z is an amphibian?

- (1) Check if animal Z swims.
- (2) Check if animal Z lays eggs.
- (3) Check if animal Z lives on land.
- (4) Check if animal Z has moist skin.

()

- 12 The diagram shows living thing M growing on a slice of bread. It breaks down the bread into simpler substances.

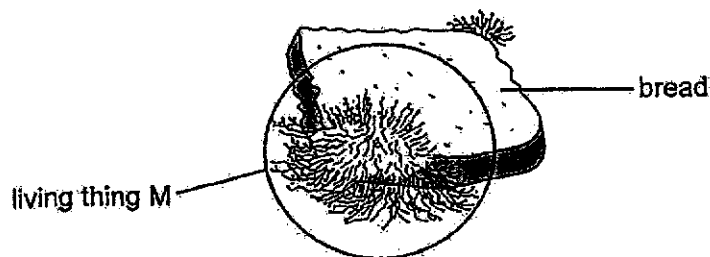

Which one of the following statements about living thing M is correct?

- (1) Living thing M is classified as fungi.
- (2) Living thing M reproduces by seeds.
- (3) Living thing M makes its own food using sunlight.
- (4) Living thing M can only be seen with a microscope.

()

- 13 Tom placed four strips of materials, P, Q, R and S into a tray of water as shown below.

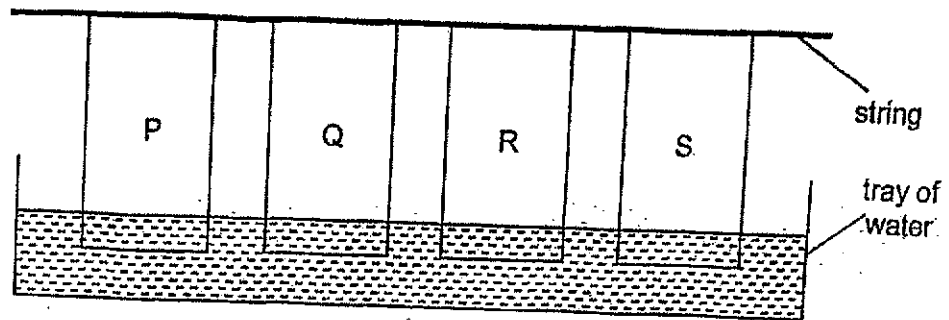

The diagram below shows the amount of water absorbed by the four strips of materials after ten minutes.

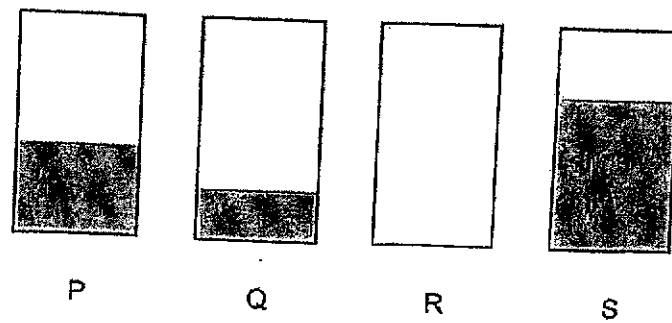

Based on the results, which material, P, Q, R or S is most suitable to be made into a bath towel?

- (1) P
- (2) Q
- (3) R
- (4) S

()

- 14 The diagram below shows a man using a parachute to reach the ground from a great height.

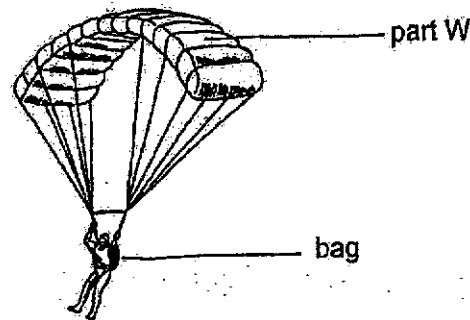

Which of the following students are correct in explaining the properties of the material used to make part W?

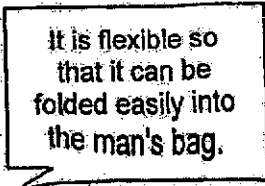

Mike

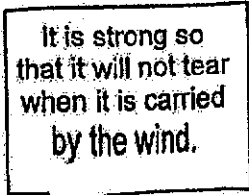

Sara

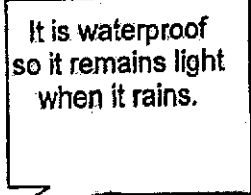

Tom

- (1) Mike and Sara only
 (2) Mike and Tom only
 (3) Sara and Tom only
 (4) Mike, Sara and Tom

()

- 15 Mei Yan conducted an experiment with material T as shown below. She continued to hang some weights from material T until it broke.

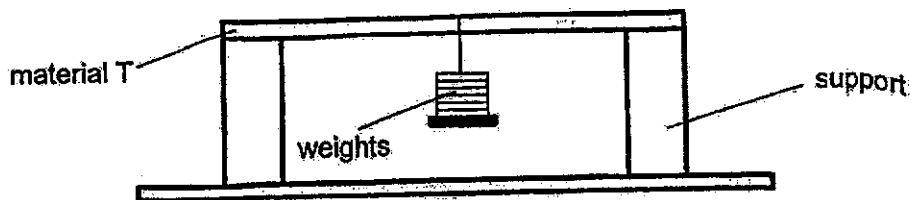

Mei Yan is trying to find out how _____ material T is.

- (1) heavy
 (2) strong
 (3) flexible
 (4) transparent

()

- 16 The diagram shows a baby's diaper. The baby's urine is contained in part X of the diaper.

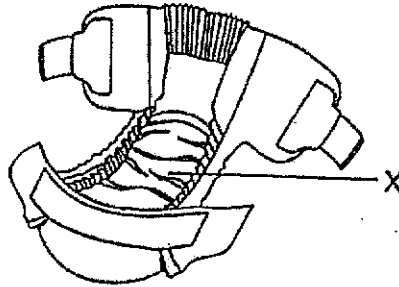

What properties of materials are required to make part X of the diaper?

	Flexible	Strong	Waterproof
(1)	✓	✓	✓
(2)		✓	✓
(3)	✓	✓	
(4)	✓		✓

Key: A tick (✓) shows the presence of the property

- 17 The diagram shows a freely-suspended bar magnet. The bar magnet is at rest.

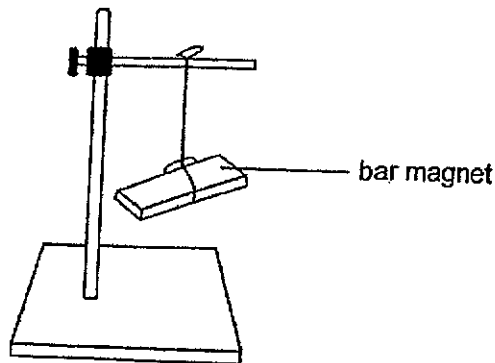

At rest, the bar magnet is pointing in the _____ direction.

- (1) east-west
- (2) north-east
- (3) north-west
- (4) north-south

- 18 The diagram shows a toy set. A metal rod is used to lift the metal fish out of the toy pond. The fish are not attracted to each other.

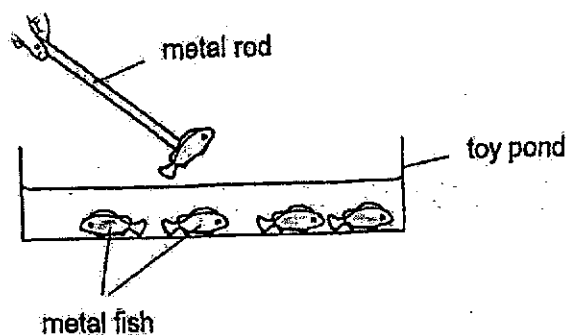

Which of the following statements about the toy set are likely to be correct?

- A The metal rod is a magnet.
- B The metal fish are magnets.
- C The metal fish are not magnets.
- D The toy pond is made of plastic.

- (1) A and C only
- (2) B and D only
- (3) A, C and D only
- (4) A, B and D only

()

19 Harry arranged two bar magnets and a compass as shown in the diagram below.

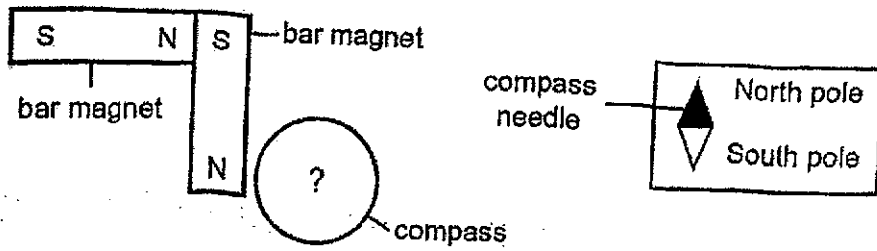

Which of the following shows the correct direction of the compass needle in the above diagram?

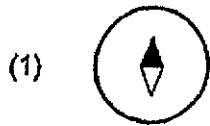

()

- 20 Mei Ling carried out four experiments with a bar magnet as shown below. She brought some objects near the bar magnet and observed what happened.

Experiment			
	Bar Magnet	Object	Result
A	N S	Aluminium Bar	attract
B	N S	S N	repel
C	N S	Iron Bar	attract
D	N S	N S	repel

Which of the following results with the bar magnet are correct?

- (1) A and B
- (2) C and D
- (3) B and C
- (4) A and D

()

End of Booklet A



HENRY PARK PRIMARY SCHOOL
2024 END OF YEAR EXAMINATION
SCIENCE
PRIMARY THREE
BOOKLET B

Name: _____ ()

Class: Primary 3 ()

15 QUESTIONS

40 MARKS

TOTAL TIME FOR BOOKLETS A & B: 1 HOUR 30 MINUTES

INSTRUCTIONS TO CANDIDATES

1. Do not turn over this page until you are told to do so.
2. Follow all instructions carefully.
3. Answer all questions.

Marks for Booklet B: _____ / 40

For each question from 21 to 28, write your answers in the spaces provided.

(40 marks)

21 Study the diagram shown below.

Write the names of the plant parts in the boxes given.

[2]

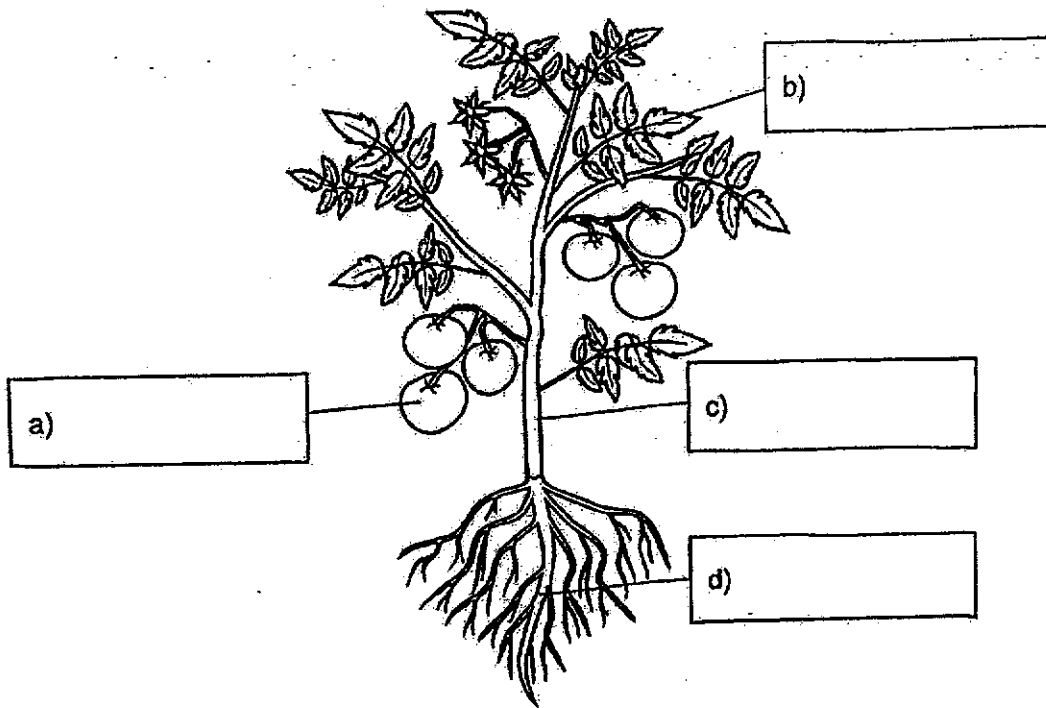

22 Read the following statements about fungi and bacteria.

Tick (✓) the boxes given if the statements are correct.

[2]

a) All bacteria are harmful.

b) Yeast is a type of fungi.

c) Mushrooms reproduce by seeds.

d) Bacteria come in different shapes and sizes.

23 The diagram shows insects P and Q.

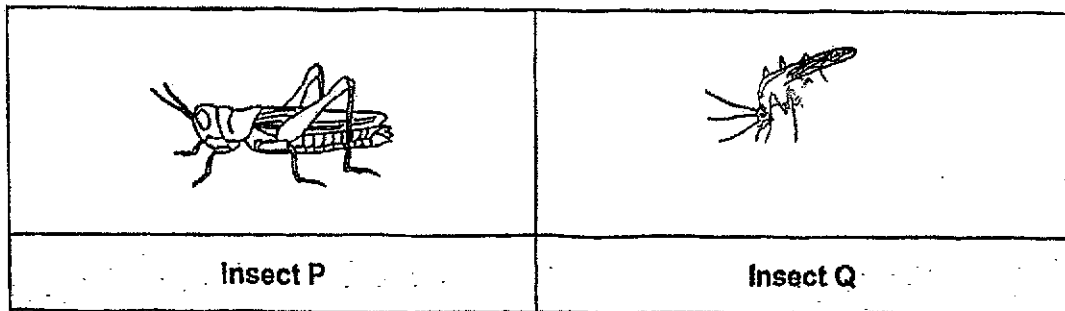

Circle the correct answers.

a) The young of insect P is called (larva / pupa / nymph). [1]

The young of insect Q is called (egg / larva / nymph).

P and Q are classified as insects.

b) Insects P and Q have three _____ and
six _____ [1]

- 24 The table describes the stages of the life cycles of four animals, K, L, M and N.

Characteristics	Animal			
	K	L	M	N
It has a pupal (pupa) stage.	✓	x	x	x
The eggs are laid in water.	x	✓	✓	x
The young looks like the adult.	x	✓	x	✓

Key: (✓) - characteristic is present (x) - characteristic is absent

The diagrams below show a cockroach and a mealworm beetle.

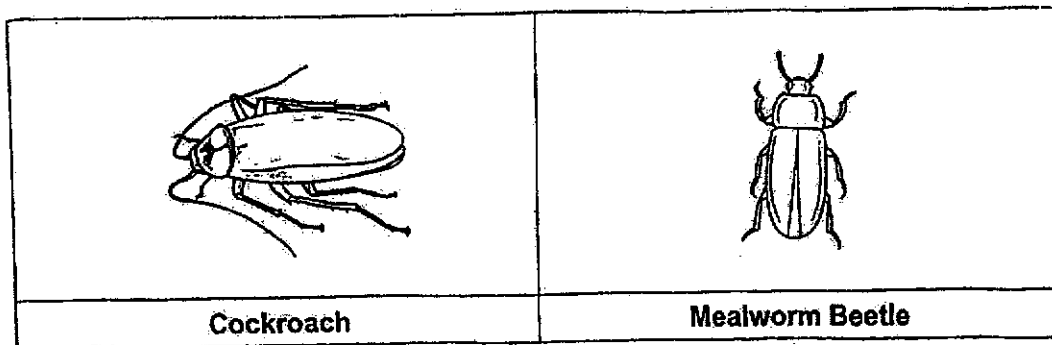

Which of the following animals is likely to be animals K, L, M or N?
Based on the information given, tick (✓) the correct boxes below.

[2]

Animal	Animal			
	K	L	M	N
Cockroach				
Mealworm Beetle				

25 The diagram shows Susan in her swimming costume with a float.



Based on the information given, state whether the statements below are true or false. [2]
Write "True" or "False" in the correct boxes.

	Statement	Write 'True' or 'False'
a)	The material used to make the float absorbs water.	
b)	The material used to make the swimming costume is flexible.	

26 The flowchart below shows how some materials, A, B, C, D and E, are classified.

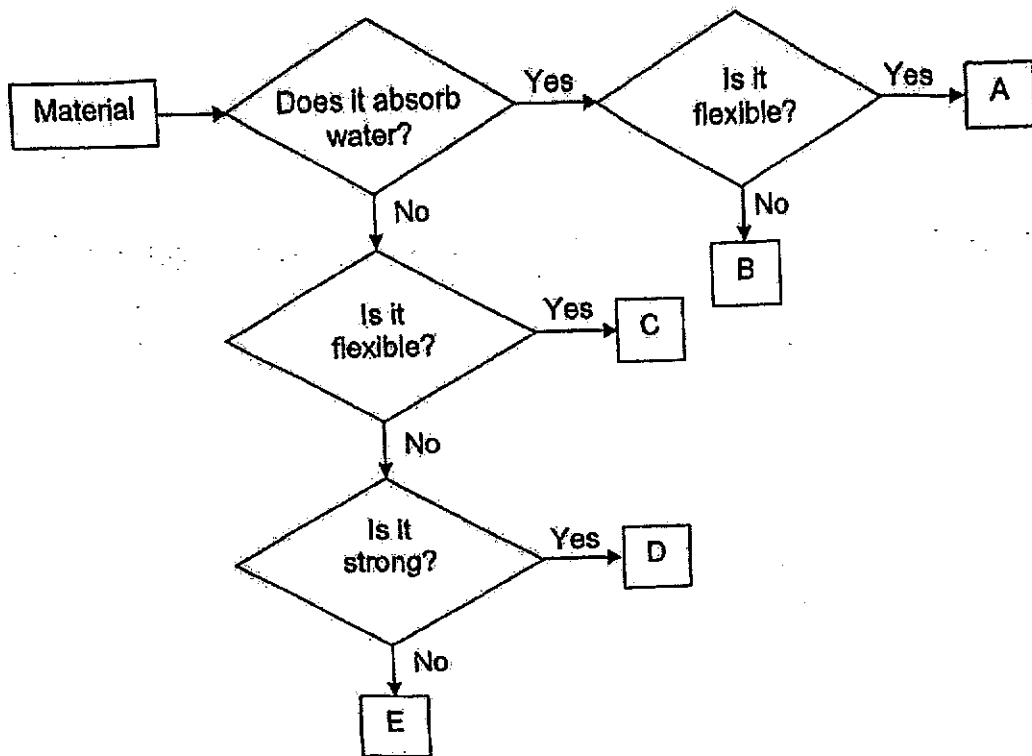

The diagram below shows a boat.

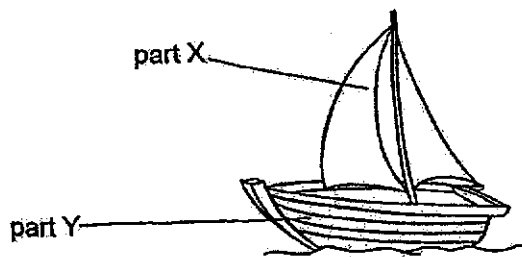

Name the material, A, B, C, D or E, that is most suitable to make

a) part X of the boat - material _____

[1]

b) part Y of the boat - material _____

[1]

27 A magnet is used to hold a piece of paper on the refrigerator as shown below.

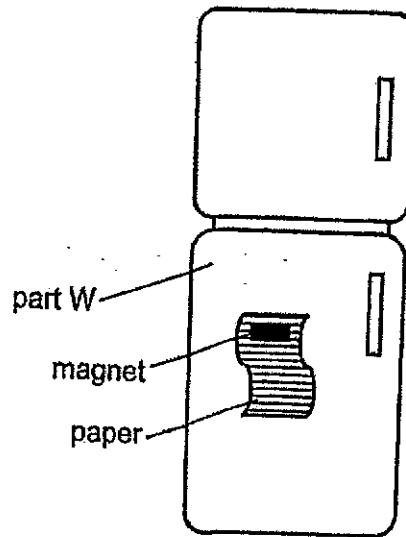

- a) Part W is _____ to the magnet as it is made of a magnetic material. [1]
- b) The paper is made of a _____ material. [1]

28 The diagram below shows three ring magnets on a wooden rod.

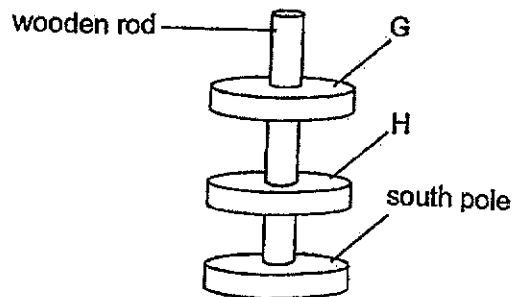

Name the poles labelled as G and H in the diagram above.

[2]

G - _____ pole

H - _____ pole

For each question from 29 to 35, write your answers in the spaces given.

- 29 Adam wanted to find out whether animals need food to live. He prepared two similar set-ups, M and N, as shown below. He placed some flies in set-up N.

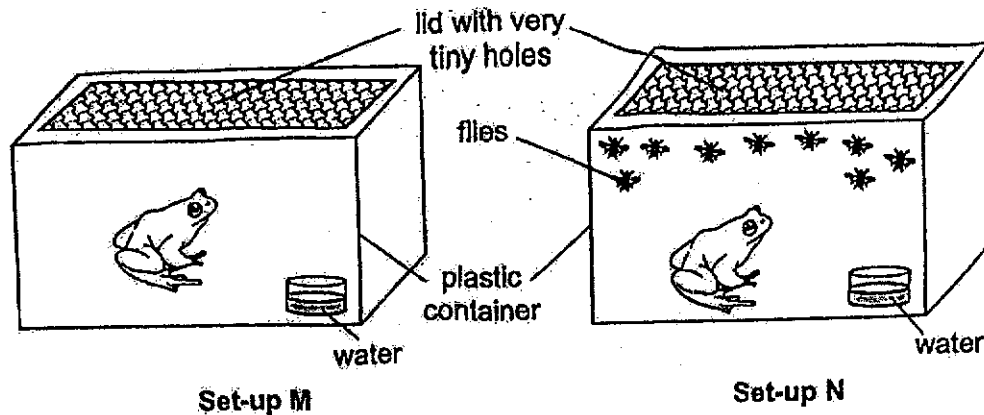

- a) In which set-up, M or N, is the frog likely to live longer? [1]
Explain your answer.

- Adam decided to cover the tiny holes in each lid in set-ups M and N.
b) What will happen to the frogs in the set-ups after some time? [2]
Explain your answer.

- 30 Mr Ahmad kept two different types of bacteria, X and Y, in separate containers for an experiment. He added the same amount of substance P to each container at the start of the experiment. He observed how bacteria X and Y responded to substance P. His results are shown in the bar graphs below.

Bar Graph 1 – Bacteria X

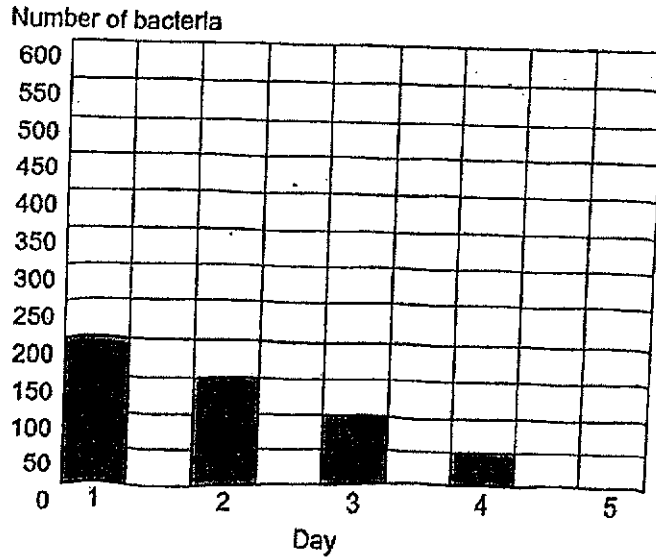

Bar Graph 2 – Bacteria Y

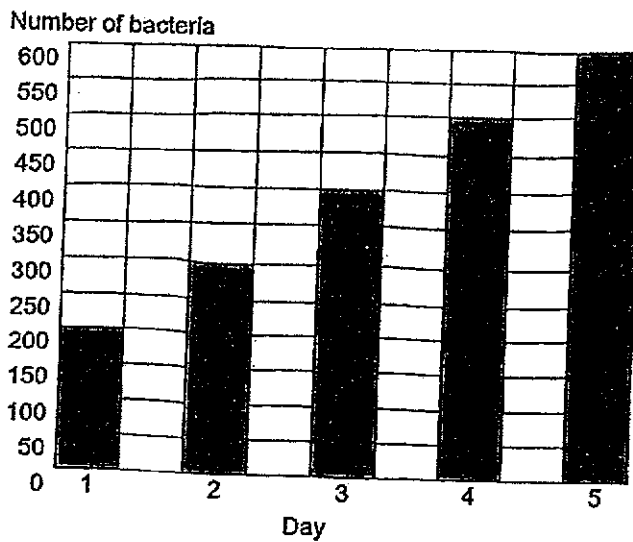

- a) Based on the results, state how the number of bacteria X and Y changed (*increased, decreased or remained the same*) during the 5 days. [2]

(i) number of bacteria X: _____

(ii) number of bacteria Y: _____

Question 30 continued

- b) Suggest a reason for the change in the number of bacteria X during the 5 days. [1]

Bacteria are very small.

- c) Suggest one way Mr. Ahmad was able to observe them during his experiment. [1]

- 31 The characteristics of two animals, J and K, are shown in the table below.

Characteristics	Animal	
	J	K
Able to fly	Yes	No
Gives birth to young alive	No	Yes
Has feathers as outer covering	Yes	No

- a) Based on the table above, state two differences between animal J and K. [2]

Difference 1:

Difference 2:

- b) Name the animal group animal J belongs to. [1]

Animal group: _____

Give a reason for your answer.

- 32 The bar graph shows the number of days for each stage in the life cycle of insect G.

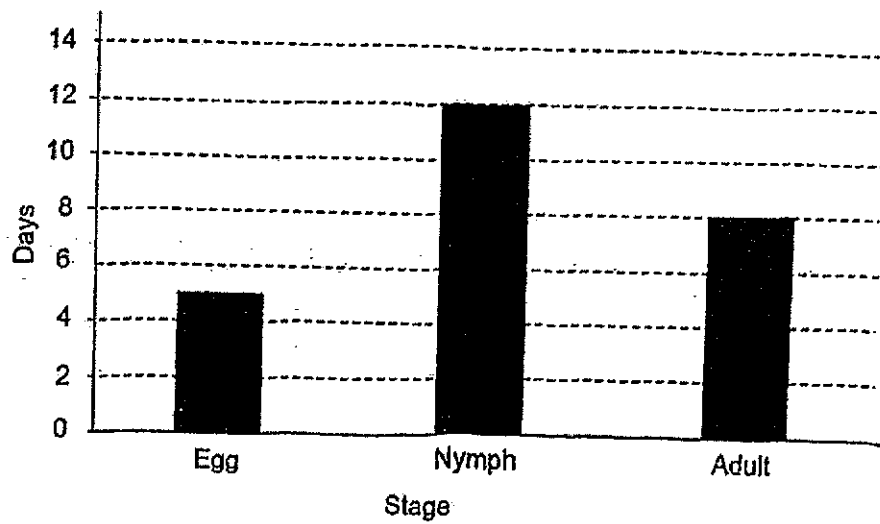

- a) How does insect G reproduce? [1]
-
- b) How many stages are there in the life cycle of insect G? [1]
-
- c) How many days would it take for insect G to become an adult after the egg is hatched? [1]
-
- John stated that insect G is likely to be a beetle.
- d) Is John correct? Give a reason for your answer. [1]
-
-

- 33 The diagram below shows Sam's toy duck in a tub of water.

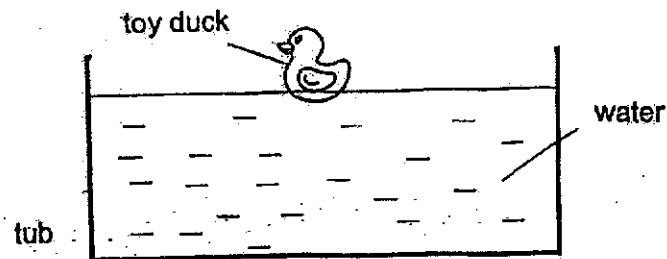

Sam then tested the properties of the materials, P, Q and R. He recorded his results in the table below.

Properties	Material		
	P	Q	R
It is waterproof.	✓	✗	✓
It floats on water.	✗	✓	✓

Key: (✓) - property is observed (✗) - property is not observed

- a) From the table above, state the two properties of material Q. [1]

- b) Which material, P, Q or R, is most suitable to make the toy duck? [2]

Material _____

Explain your answer.

When Sam squeezed the toy duck, he was able to do it easily.

- c) What property of the material allowed him to squeeze the toy duck easily? [1]

- 34 Joan clamped a bar magnet as shown below.
A steel paper clip, tied to the bench using a string, was found to remain in the air.

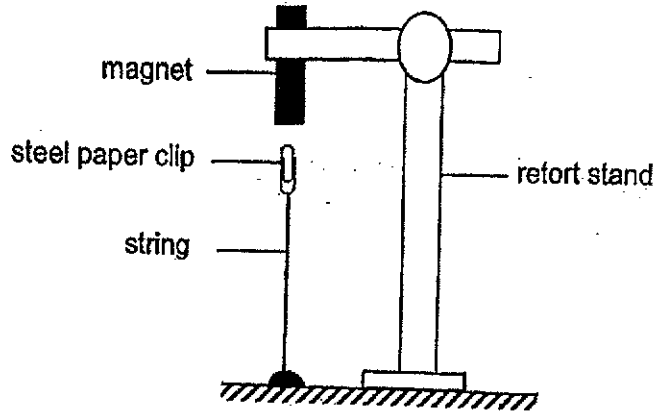

- a) Explain why the steel paper clip did not drop. [2]

- b) State what Joan would observe if a plastic paper clip is used in the above set-up. [1]
Give a reason for your answer.

- 35 Danny wanted to find out which parts of a magnet are the strongest. He used a bar magnet and a rod magnet for his experiment. He placed thumbtacks, one at a time, at different parts of each magnet until no more thumbtacks could be attracted by each magnet. He observed the following results shown below.

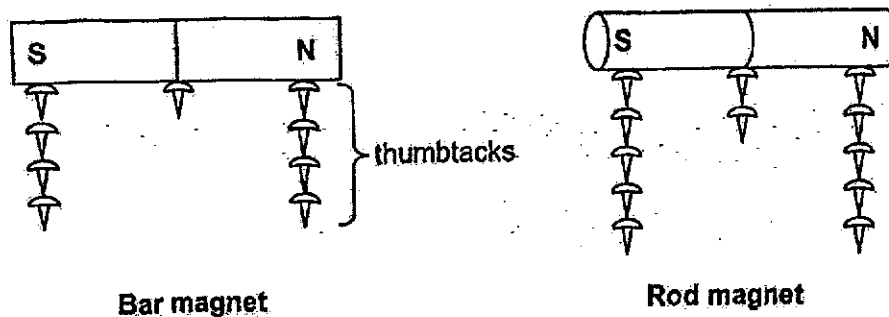

- a) Based on the results, which parts of the bar and rod magnets are the strongest? [1]
Explain your answer.

- b) Based on the results, which magnet, bar magnet or rod magnet, is stronger? [1]
Explain your answer.

Danny placed part Y of object W near the rod magnet.

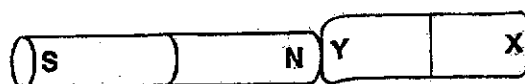

Object W

The rod magnet attracted object W as shown in the diagram above.
Danny stated that object W must be a magnet.

- c) Is Danny correct? Explain your answer. [1]

~ End of Booklet B ~

SCHOOL : HENRY PARK PRIMARY SCHOOL
 LEVEL : PRIMARY 3
 SUBJECT : SCIENCE
 TERM : 2024 SA2

Q1	Q2	Q3	Q4	Q5	Q6	Q7	Q8	Q9	Q10
2	2	1	1	4	1	2	2	1	3
Q11	Q12	Q13	Q14	Q15	Q16	Q17	Q18	Q19	Q20
4	1	4	4	2	3	4	3	4	3

Q21	a)fruits b)leaf c)stem d)roots
Q22	b, d
Q23	a)nymph / larva b)Insects P and Q have three body parts and six legs.
Q24	Cockroach ----N Mealworm Beetle ---- K
Q25	a) False b) True
Q26	a) C b) D
Q27	a) attracted b) non-magnetic
Q28	G – south pole H – North pole
Q29	a) Set-p N because unlike set-up M, it has flies witch is a food source for the frog, so it has food to eat and stay alive.

	<p>b) The frogs will die because they will have no air to breath and living thing need air, food and water to survive making the frogs die.</p>
Q30	<p>a)i)decreased ii)increased b)Substance P killed bacteria X. c)Use a microscope.</p>
Q31	<p>a)1)J is able to fly but K is not 2) K gives birth to young alive but J does not. b)Animal group : Birds Birds because J is able to fly, does not give birth to young alive and has feathers as outer covering.</p>
Q32	<p>a) By laying eggs. b) 3 c) 12 d) No, because beetles have a four-stage life cycle.</p>
Q34	<p>a) The magnet was able to attract the paper clip. b) The plastic clip will drop as it is not a magnetic material.</p>
Q33	<p>a)Q is not waterproof and floats on water. b)R R because it is a waterproof and it can float on water. c)It is flexible.</p>
Q35	<p>a) The poles because at the poles the most thumbtacks were attracted. b) Rob magnet because it attracted more thumbtacks than the bar magnet. c) No, because object W might be a magnetic material, making it attract.</p>