



PEI HWA PRESBYTERIAN PRIMARY SCHOOL
SEMESTRAL ASSESSMENT

PRIMARY 3
SCIENCE
(BOOKLET A)

24th OCT 2024

Name: _____ ()

Class: Responsibility _____

Total time for Booklets A and B: 1 h 30 min

INSTRUCTIONS TO CANDIDATES

1. Write your Name, Class and Register No. in the spaces provided above.
2. DO NOT turn over this page until you are told to do so.
3. Follow all instructions carefully.
4. Answer all questions.
5. Shade your answers on the Optical Answer Sheet (OAS) provided.

This booklet consists of 17 printed pages, excluding the cover page.

For each question from 1 to 24, four options are given. One of them is the correct answer. Make your choice and shade the oval (1, 2, 3 or 4) on the Optical Answer Sheet provided. (48 marks)

1 The diagram below shows two living things.



potted plant

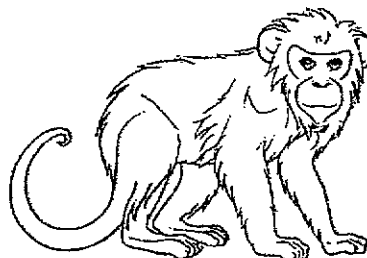

monkey

Which of the statements of the two living things are true?

- A Both can grow.
 - B Both can reproduce.
 - C Both can make their own food.
 - D Both respond to changes around them.
-
- (1) A and B only
 - (2) C and D only
 - (3) A, B and D only
 - (4) A, B, C and D

2

- 2 Victor decided to keep his pet hamster in a cage as shown below.

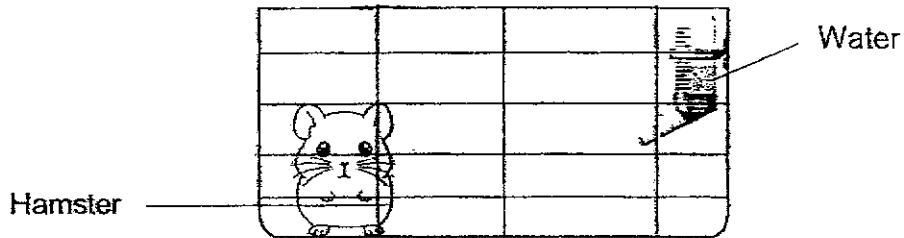

What is missing from the diagram to ensure that the hamster stays alive?

- (1) Air
 - (2) Wind
 - (3) Food
 - (4) Sunlight
- 3 The diagram below shows Animal H.

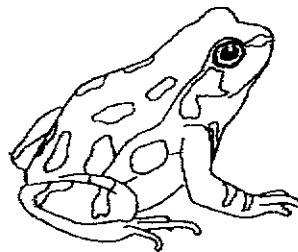

Which statement is not correct about the animal group that Animal H belongs to?

- (1) They lay eggs.
- (2) They live both on land and in water.
- (3) They have a body covered with scales.
- (4) They breathe using their lungs when on land.

3

4 Study the classification table below.

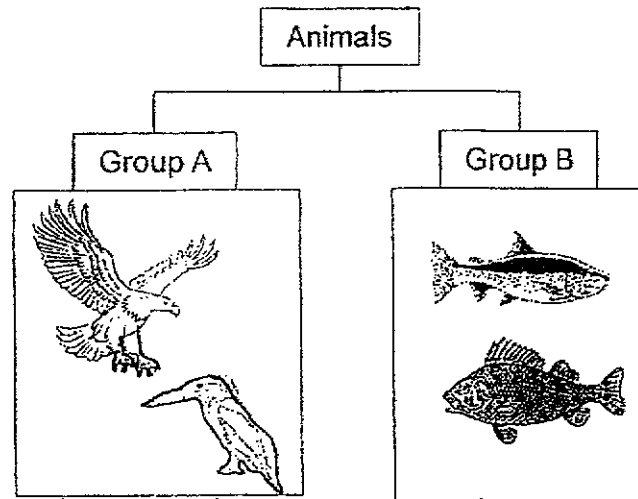

which of the following set

Which of the following set of headings best represents Group A and B?

	Group A	Group B
(1)	Breathe through skin	Breathes through lungs
(2)	Body covered with hair	Body covered with scales
(3)	Live on land	Lives in water
(4)	Giving birth to young	Lay eggs

5 Aaron described a living thing as follows.

- Reproduce by spores
- Feeds on dead or living matter
- Can be seen without a microscope

Which group does this living thing most likely belong to?

- (1) fungi
- (2) plant
- (3) animal
- (4) bacteria

4.

6 Study the table below.

Things	Need air to survive	Need water to survive	Able to make its own food	Able to move from place to place
S	√	√	√	
T				
U	√	√		√

The following statements were made of S, T and U.

- A S could be a living thing.
- B T could be a non-living thing.
- C S could belong to the fungi group.
- D U could belong to mammal group.

Which statements are true?

- (1) A and B only
- (2) C and D only
- (3) B, C and D only
- (4) A, B and D only

7 Pat conducted a test on 4 bags made from different materials. The table below shows how much mass each bag can hold without breaking.

Bag	Amount of mass bag can hold before breaking (kg)
G	3
H	9
I	12
J	5

Which bag should Pat use to carry an object weighing 11 kg?

- (1) G
- (2) H
- (3) I
- (4) J

5

- 8 The diagram below shows a trampoline. The trampoline has part E attached to a metal frame with springs that helps the girl to jump in the air.

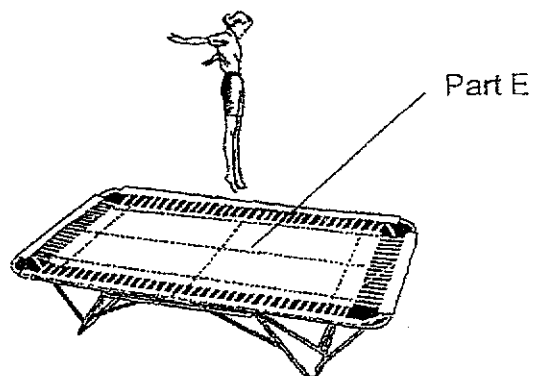

Part E must be made of a material that is _____.

- (1) strong and flexible
- (2) strong and can float on water
- (3) flexible and can float on water
- (4) transparent and can float on water

6

- 9 Chloe carried out an experiment by placing materials C, D, E and F into a container of water. The results are shown below.

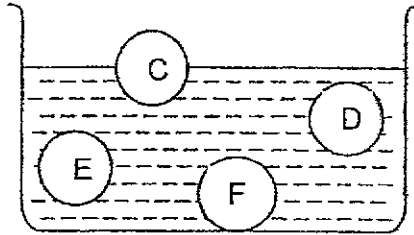

Chloe uses a float at the swimming pool.



Which material, C, D, E or F, will be most suitable to make the float shown above?

- (1) C
- (2) D
- (3) E
- (4) F

7

- 10 The diagram below shows a flag used in a competition.

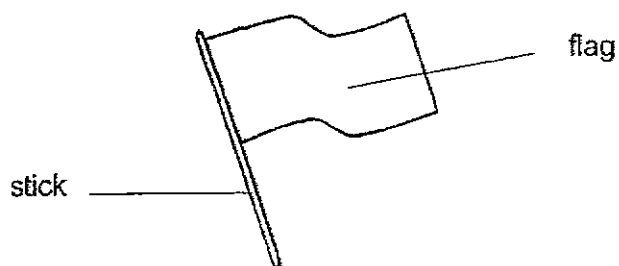

Identify the properties of the two parts that work together to carry out its function.

	Flag	Stick
(1)	float on water	sink in water
(2)	weak	strong
(3)	waterproof	non-waterproof
(4)	flexible	stiff

11 G is taken from a fruit of a plant. Which of the following correctly shows G in the life cycle of a plant?

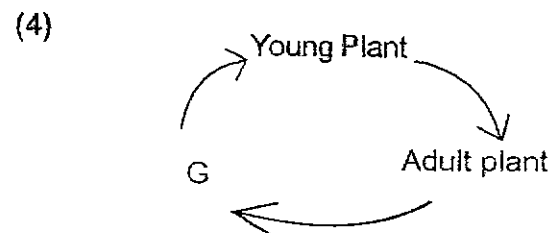
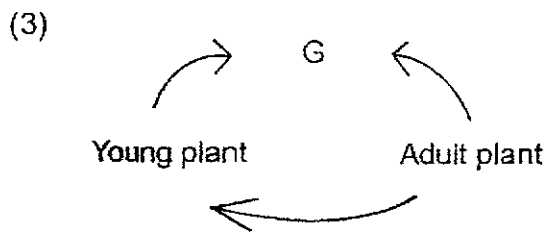
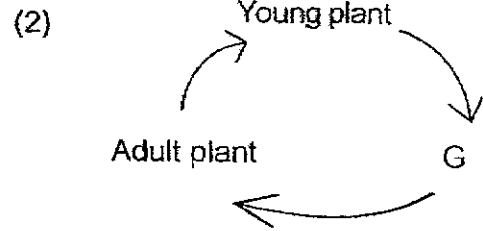
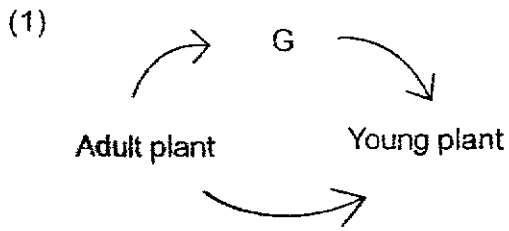

12 Caleb observed some living things as shown below.

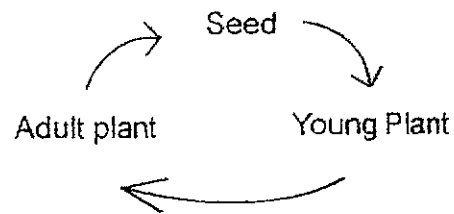
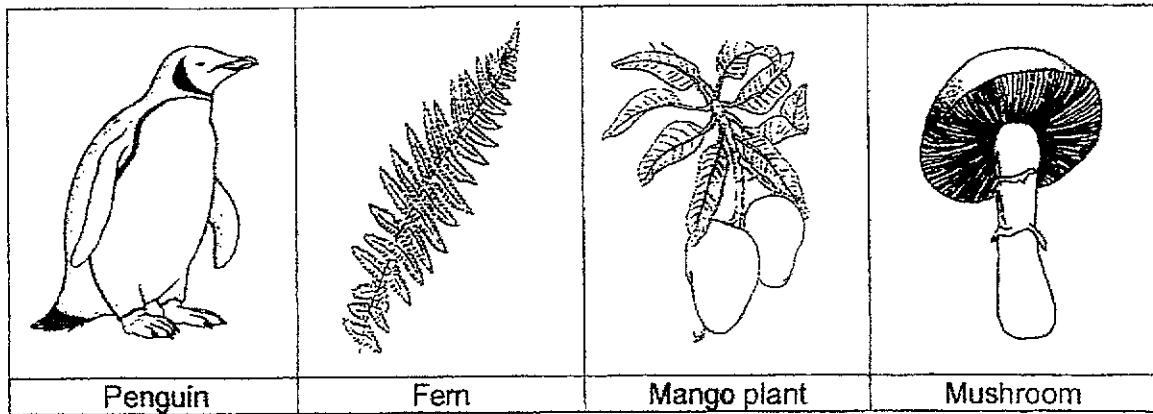

Which of the following living things has/have the life cycle above?

- (1) Penguin only
- (2) Mushroom only
- (3) Mango plant only
- (4) Fern and Mango only

- 13 The diagram below shows the life cycle of an insect.

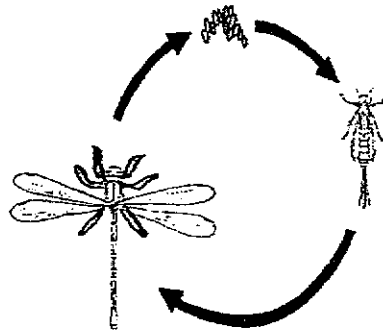

Which of the following animals has a similar life cycle to the one above?

- (1) Mosquito
- (2) Butterfly
- (3) Cockroach
- (4) Mealworm Beetle

- 14 Study the flowchart below.

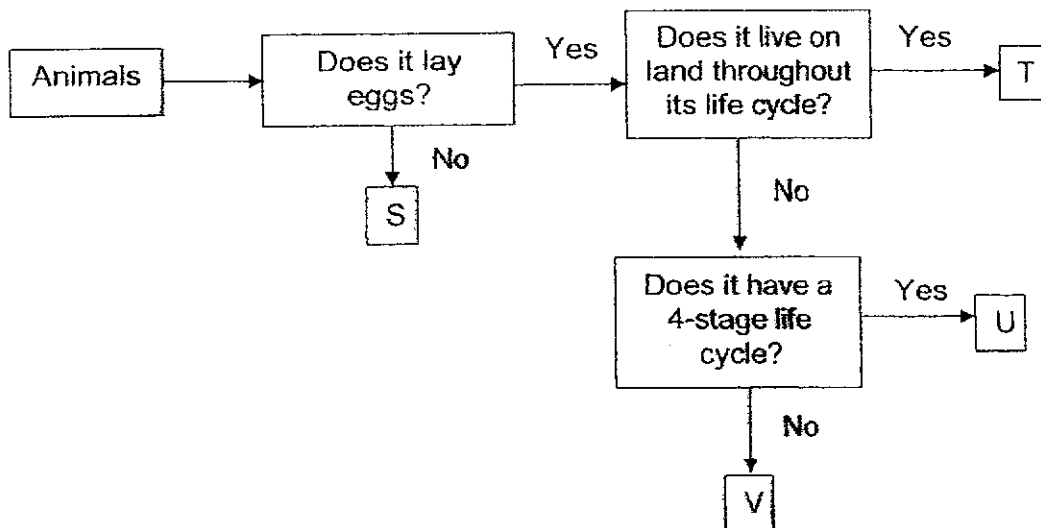

Based on the flowchart, which of the following is true?

- (1) Animal V lay eggs and has a 4-stage life cycle.
- (2) Animal S does not lay eggs but has a 4-stage life cycle.
- (3) Animals U and T live on land throughout their life cycle.
- (4) Animal T lays eggs and lives on land throughout its life cycle.

- 15 Study the lifecycle of an animal below. Each letter represents a stage.

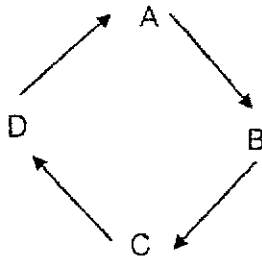

If B represents the pupa stage, what stage does A represent?

- (1) Egg
 - (2) Larva
 - (3) Adult
 - (4) Nymph
- 16 The bar graph shows the number of days that Animal J remains at each stage of its life cycle.

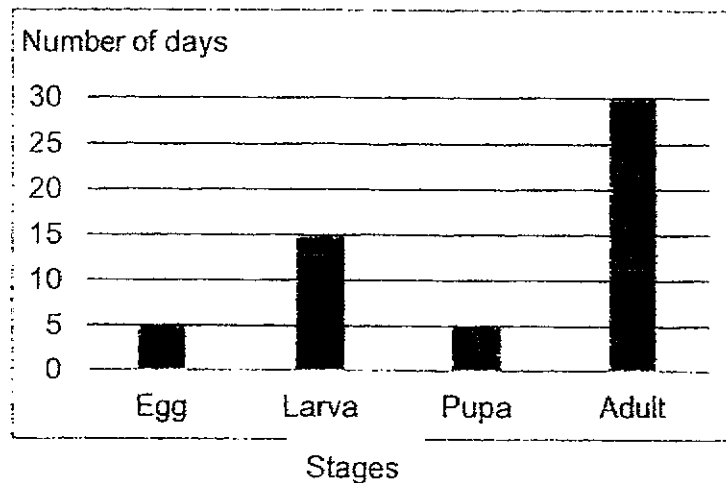

How many days does it take for Animal J to become an adult after hatching from its egg?

- (1) 5
- (2) 20
- (3) 25
- (4) 55

- 17 Carys recorded the characteristics of the life cycle of a butterfly and a frog. A tick (✓) shows that the animal has the characteristic.

	Characteristics	Butterfly	Frog
C	Lays eggs in water		✓
D	Has 3 stages in its life cycle		✓
E	The young resemble the adult		✓

Which of the following shows the correct characteristic(s) of the two life cycles?

- (1) C only
 - (2) D only
 - (3) C and D only
 - (4) C, D and E
- 18 Mary tested the magnetic strengths of magnets D, E, F and G by moving an iron nail slowly towards each magnet and measuring the distance at which the nail was attracted. The results are shown in the diagram below.

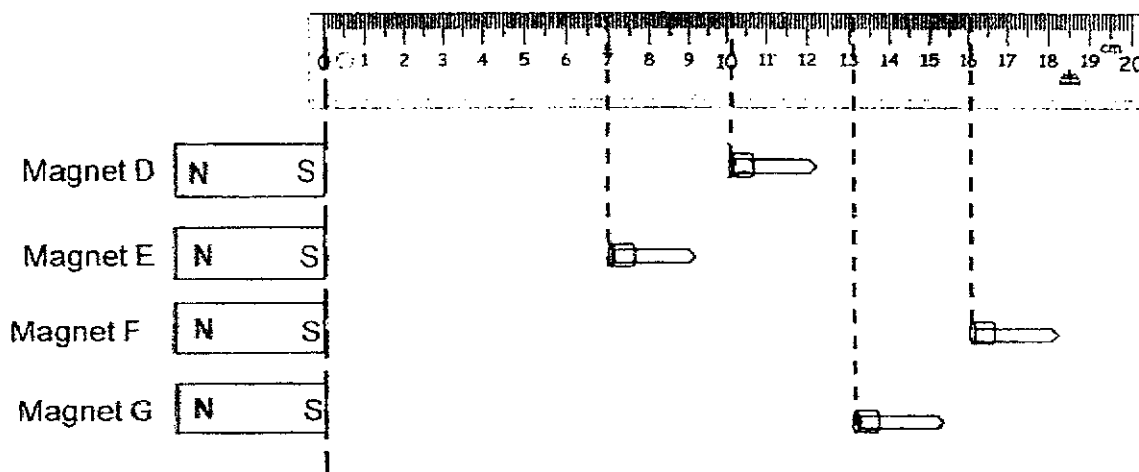

Based on the results, the magnetic strength of magnet _____.

- (1) E is the greatest
- (2) D and magnet F is the same
- (3) D is lesser than that of magnet E
- (4) F is greater than that of magnet G

19 In which of the following will the two magnets push each other away?

(1)

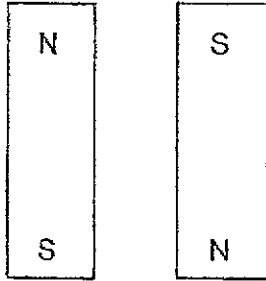

(2)

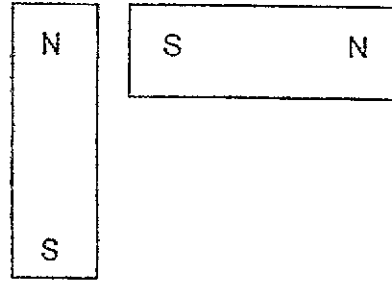

(3)

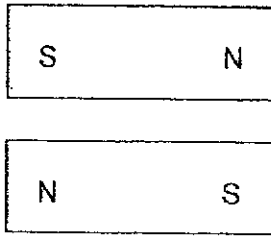

(4)

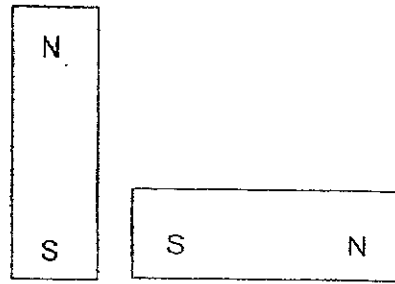

- 20 Study the arrangement of the magnets below. The North pole of a magnet is given in the diagram.

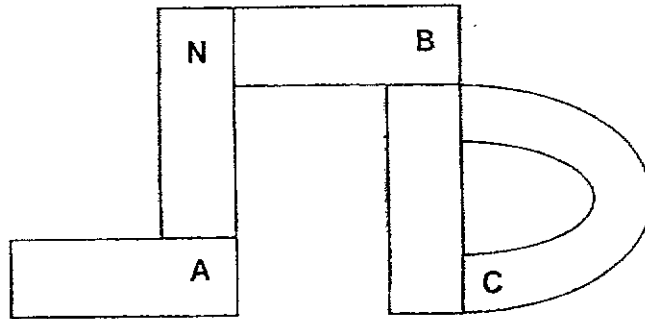

Which of the following shows the correct poles at points A, B and C?

	A	B	C
(1)	north	north	north
(2)	south	north	south
(3)	north	north	south
(4)	south	south	north

21 Study the following diagram below.

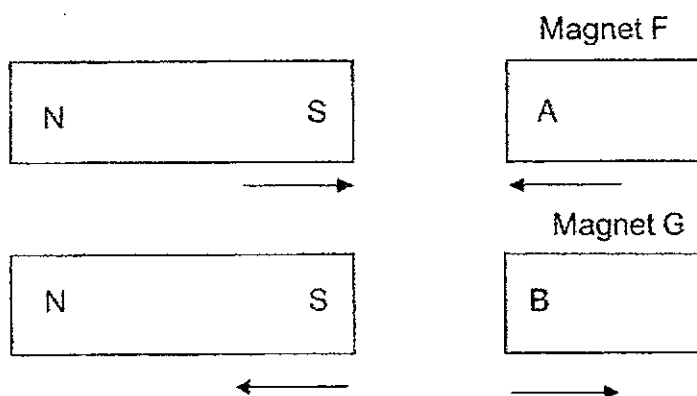

Magnets F and G were then brought close to each other as shown below.



What will be observed when magnets F and G are placed together?

- (1) They will repel.
- (2) They will attract.
- (3) Magnet F and G will repel first and then attract.
- (4) Magnet F and G will attract first and then repel.

- 22 Debbie stroked 2 similar nails, G and H, with the same bar magnet. Nail G was stroked 20 times and Nail H was stroked 30 times. She then placed the nails 4 cm from the steel clips and recorded the number of steel clips attracted.

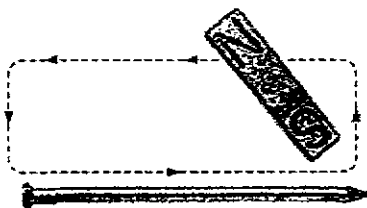

Which of the following is the most likely results recorded by Debbie?

Number of steel clips attracted by		
	Nail G	Nail H
(1)	9	7
(2)	5	3
(3)	8	12
(4)	10	9

- 23 Using the electrical method, Zetian used batteries, wires and Object W to make an electromagnet. However, Object W did not attract any iron nail.

Which of the following is/are possible reason(s) as to why Object W did not attract any iron nail?

- A There were too few batteries used.
 - B There were too many coils of wires around Object W.
 - C The wires were not correctly connected to the ends of the battery.
- (1) B only
 - (2) C only
 - (3) A and C only
 - (4) A, B and C

- 24 Susan wanted to find out if the size of a magnet affects its magnetic strength. She set up the experiment below with 4 magnets of different sizes.

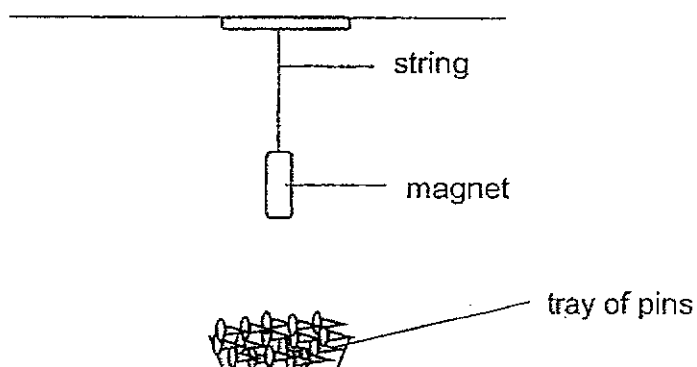

Which of the following should she change to ensure her experiment is fair?

- (1) Size of magnet
- (2) Type of magnet
- (3) Number of pins in the tray
- (4) Distance of magnet away from the tray of pins



PEI HWA PRESBYTERIAN PRIMARY SCHOOL
SEMESTRAL ASSESSMENT

PRIMARY 3
SCIENCE
(BOOKLET B)

24th OCT 2024

Name: _____ ()

Class: Responsibility _____

Parent's Signature

Total time for Booklets A and B: 1 h 30 min

INSTRUCTIONS TO CANDIDATES

1. Write your Name, Class and Register No. in the spaces provided above.
2. DO NOT turn over this page until you are told to do so.
3. Follow all instructions carefully.
4. Answer all questions.
5. Write all your answers in this booklet.

Marks (Booklet A) :	48
Marks (Booklet B) :	32
Total Marks (Booklets A & B) :	80

This booklet consists of 9 printed pages, excluding the cover page.

Write your answers to the questions 25 to 33 in the spaces provided.
The number of marks available is shown in brackets [] at the end of each question or part question. (32 marks)

25 Esther was given 2 sets of objects as shown below.

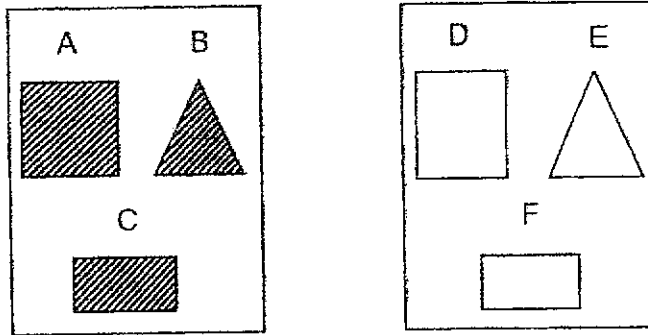

(a) The objects above are classified according to their _____. [1]

(b) (i) Using another characteristic, write the letters, A, B, C, D, E and F in the set to show how the objects above can be classified. [2]

Set V	Set W
_____	_____
_____	_____
_____	_____
_____	_____

(ii) Based on your answer in (b)(i), give a suitable heading for Set V and W. [1]

Set V: _____

Set W: _____

(Go on to next page)

PLEASE DO NOT WRITE IN THIS MARGIN

PLEASE DO NOT WRITE IN THIS MARGIN

26 Study the classification table below.

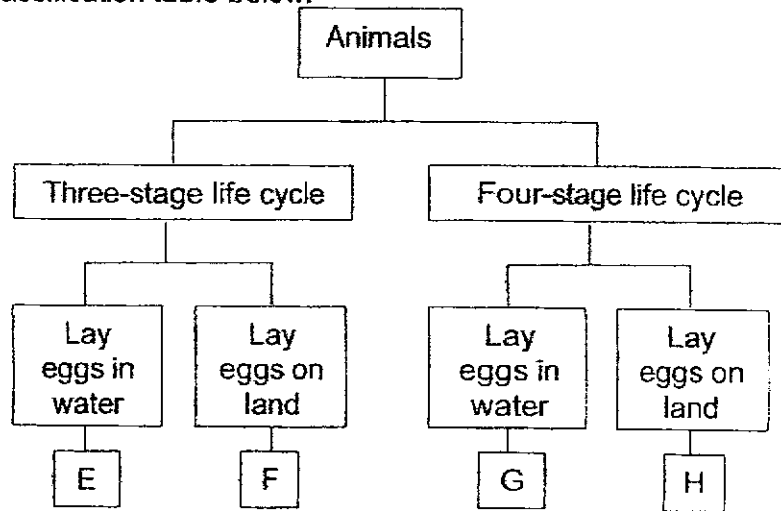

- (a) Based on the classification table, state the characteristics of animal E. [1]
-
- (b) State one difference between Animals F and H. [1]
-
- (c) Based on the classification chart above, which animal E, F, G or H best represents a mosquito? [1]
-
- (d) The picture below shows a larva of a mosquito which uses its breathing tube to take in air above the water surface.

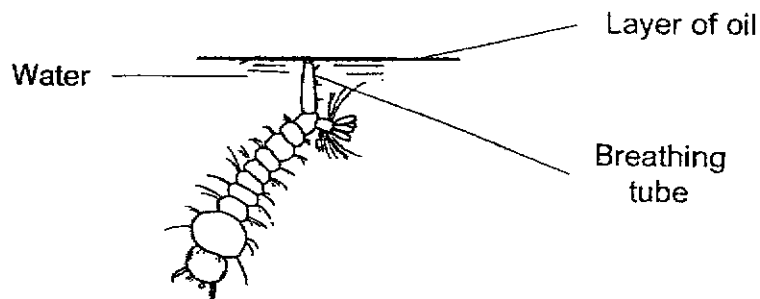

Kumar sprayed a layer of oil on the surface of the water. Give a reason why the larva died after some time. [1]

(Go on to next page)

27 Marcus conducted an experiment to test a property of 3 different materials, B, C and D, by placing a mass on them until they broke.

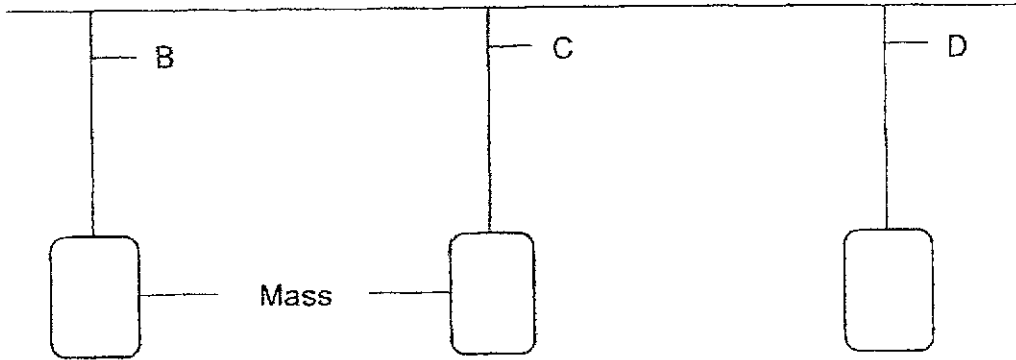

The results were then recorded in the table below.

Material	Mass hung on material until it broke (kg)
B	62
C	95
D	74

(a) What property of material was Marcus testing in the experiment above? [1]

(b) Which material, B, C or D, should Marcus use to make a chair if he weighs 77kg? Why? [2]

(Go on to next page)

PLEASE DO NOT WRITE IN THIS MARGIN

PLEASE DO NOT WRITE IN THIS MARGIN

28 John has a fish tank which allows the plant to receive sunlight as shown below.

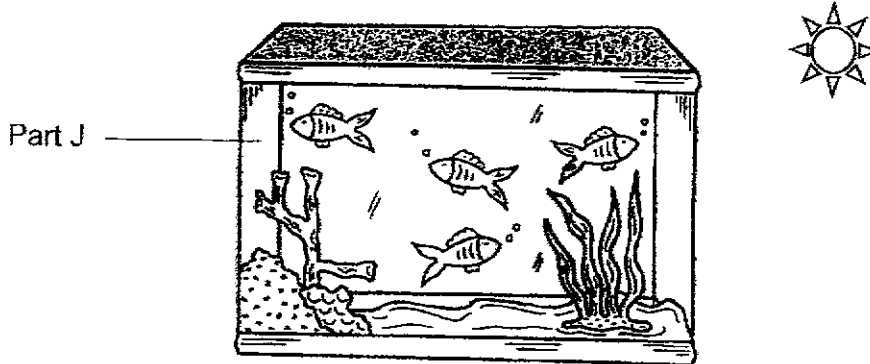

(a) Put two ticks (✓) in the boxes below to identify possible materials used to make part J of the fish tank. [2]

Material	Plastic	Wood	Glass
Tick (✓)			

(b) State the property of the material for you to make the choice in (a). [1]

29 Jennifer observed three plants G, H, and I, and recorded her observation in the table below.

Observations of plants	Plants		
	G	H	I
Has flowers	No	Yes	Yes
Has green leaves	Yes	Yes	Yes
Floats on the surface of water	Yes	Yes	No

(a) Based on the information given in the table above, state all the characteristics of Plant I. [1]

(b) State a difference between Plant G and H. [1]

(c) Which plant, G, H, or I, can a banana plant be? [1]

(Go on to next page)

PLEASE DO NOT WRITE IN THIS MARGIN

PLEASE DO NOT WRITE IN THIS MARGIN

30 The diagram below shows the life cycle of a butterfly.

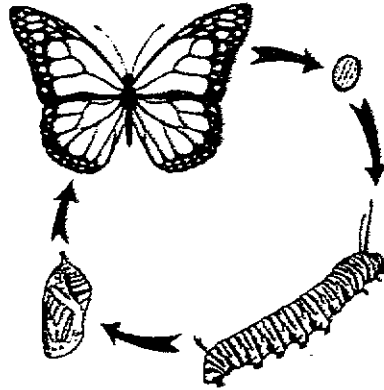

(a) State two differences between the larva and pupa stage of a butterfly. [2]

1st Difference:

2nd Difference:



(b) Which stage of the life cycle of a butterfly is considered a pest to farmers? [1]

PLEASE DO NOT WRITE IN THIS MARGIN

PLEASE DO NOT WRITE IN THIS MARGIN

(Go on to next page)

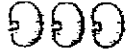
- 31 Peter prepared 4 pots with 3 seeds each. The conditions and results are shown below. A tick (✓) indicates the presence of the condition and a cross(x) indicates the absence of it.

Pot	Conditions		Results observed in each pot
	Light	Water	
W	X	✓	
X	X	X	
Y	✓	X	
Z	✓	✓	

- (a) Based on the results in the table, state the condition that does **not** affect the development of the seeds. [1]

- (b) Peter wanted to find out if water is required for the seeds to grow. Which 2 pots from the above table should he use for his experiment? [2]

(Go on to next page)

- 32 Leanne labelled magnet Q into 3 parts, J, K and L. To find out which part had the strongest magnetic strength, she placed the magnet over a tray of steel clips and recorded the results in the table below.

Magnet Q

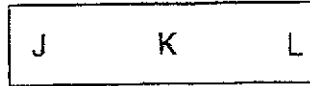

Parts of magnet Q	Number of steel clips attracted to the magnet
J	13
K	5
L	13

- (a) Based on the results above, which parts, J, K or L of the magnet have the greatest magnetic strength? Give a reason for your answer. [2]

- (b) What can Leanne do to attract more steel clips with the same magnet? [1]

Magnet Q was suspended with a string from a retort stand as shown in the diagram below.

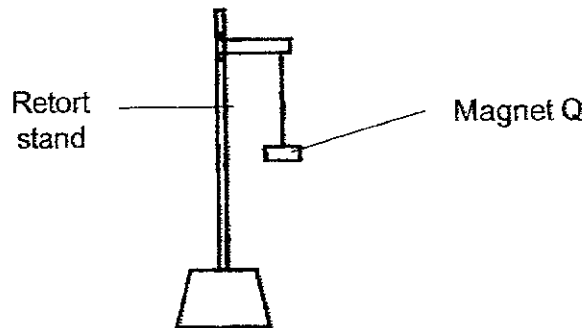

- (c) Which direction would the freely suspended magnet come to rest at? [1]

(Go on to next page)

PLEASE DO NOT WRITE IN THIS MARGIN

PLEASE DO NOT WRITE IN THIS MARGIN

- 33 Callum wanted to find out if the number of batteries affect the magnetic strength of an electromagnet. He used the electromagnet to attract some iron pins and recorded the results in the table below.

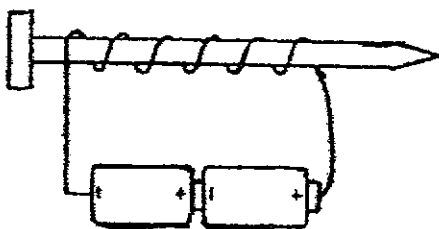

Number of batteries	Number of iron pins attracted by the electromagnet
1	3
2	6
3	10
4	15

- (a) What is the relationship between the number of batteries and the number of iron pins attracted by the electromagnet? Circle the correct answer. [1]

As the number of batteries increases, the number of iron pins attracted by the electromagnet (increases / decreases).

- (b) What must Callum keep the same to ensure the experiment is fair? Tick (✓) the box below to show the variables that needs to be changed or to keep the same. [2]

Variable	Variables to be changed	Variables to keep the same
Number of batteries		
Distance between the electromagnet and the iron pins		
Material of electromagnet		

(Go on to next page)

- (c) Without changing the number of batteries, state another way Callum do to increase the magnetic strength of the electromagnet? [1]

- (d) Callum replaced the iron pins with wooden pins. Give a reason why the wooden pins were not attracted to the electromagnet. [1]

- End of paper -

(Go on to next page)

YEAR : 2024
 LEVEL : PRIMARY 3
 SCHOOL : PEI HWA PRESBYTERIAN PRIMARY SCHOOL
 SUBJECT : SCIENCE
 TERM : SEMESTRAL ASSESSMENT

Q1	3	Q2	3	Q3	3	Q4	3
Q5	1	Q6	4	Q7	3	Q8	1
Q9	1	Q10	4	Q11	4	Q12	3
Q13	3	Q14	4	Q15	2	Q16	2
Q17	2	Q18	4	Q19	4	Q20	3
Q21	2	Q22	3	Q23	3	Q24	1

Q25	<p>a) colour b) (i) set v: a,c,d,f set W : B,E (ii) set V : 4 sides Set W : 3 sides</p>
Q26	<p>a) It has a 3 stage life cycle and it lay its eggs in water b) Animal F has a 3 stage life cycle while H has a 4 stage lifecycle c) G d) It is because the layer of oil blocked the breathing tube so it could not breathe as living things need air to survive , the larva did not have air so it died.</p>
Q27	<p>a) strength b) C . As the mass limit of C is 95kg so it is safe for Marcus.</p>
Q28	<p>a) plastic and glass b) transparency</p>
Q29	<p>a) Has flowers and has green leaves b) Plant H bears flowers but plant G does not. c) Plant I</p>
Q30	<p>a) 1st difference : The pupa cannot move from place to place 2nd difference : The larva eats but the pupa does not b) larva</p>
Q31	<p>a) light b) pots Y and Z or pots W and X</p>

Q32	a) J and L as they attracted the most clips and the poles of a magnet are the strongest. b) Leanne an lower the magnet closer to the tray of clips. c) North - South
Q33	a) Increases. b) Variables to keep the same distance between the electromagnet and the iron pins.