

Founded 1947

南侨小学

NAN CHIAU PRIMARY SCHOOL  
END YEAR EXAMINATION

2024  
SCIENCE  
PRIMARY 4  
BOOKLET A

Name / Index no.	ChuaK	( * )
Class	Primary 4	
Date	21 October 2024	
Duration for Booklets A and B	1 h 45 min	
Marks	Booklet A	56
	Booklet B	44
	Total	100
Parent's Signature		
Instructions to students	<ol style="list-style-type: none"> <li>1. Do not turn over this page until you are told to do so.</li> <li>2. Follow all instructions carefully.</li> <li>3. Answer all questions.</li> <li>4. Use a 2B pencil to shade your answers on the Optical Answer Sheets (OAS).</li> </ol>	

This paper consists of 19 pages altogether.

For each question, four options are given. One of them is the correct answer. Make your choice (1, 2, 3 or 4) and shade your answer on the Optical Answer Sheet.

[56 marks]

1. The diagram below shows a butterfly found in a garden.

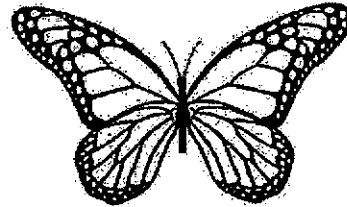

Which statement is not true about the butterfly?

- (1) It can grow.
  - (2) It can move.
  - (3) It can reproduce.
  - (4) It can make food.
2. The diagram shows the life cycle of a plant.

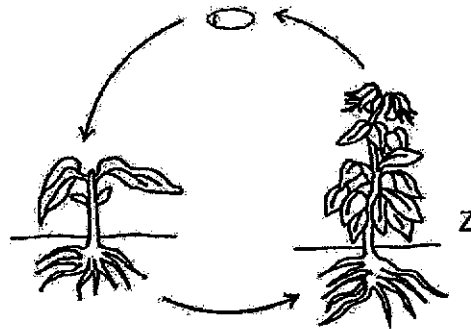

What is the stage marked Z?

- (1) egg
  - (2) seed
  - (3) adult plant
  - (4) young plant
- (3)

3. Which organ system is shown in the diagram below?

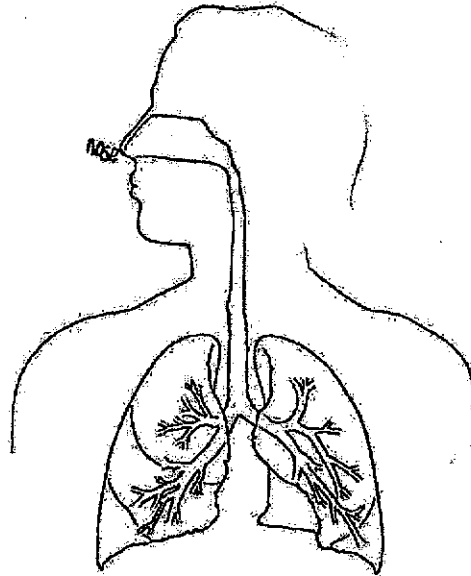

- (1) skeletal system
- (2) muscular system
- (3) circulatory system
- (4) respiratory system

4. Which of the following is a correct function of the root?

- (1) takes in air for the plant
- (2) keeps the plant upright
- (3) makes food for the plant
- (4) holds the plant firmly to the soil

5. The diagram below shows a plant.

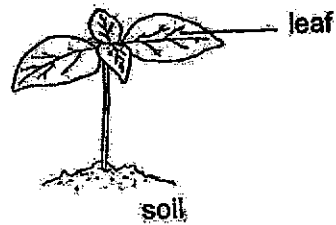

The leaf helps the plant to \_\_\_\_\_

- (1) make food
- (2) grow upright
- (3) take in water
- (4) take in mineral salts

6. Which one of the following is not a source of heat?

(1)



a light bulb \*

(2)



a candle flame

(3)

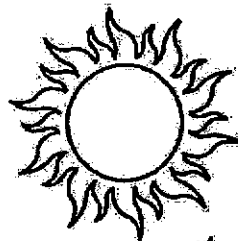

The Sun \*

(4)



a woolen cap

7. The diagram shows a knife.



Metal is used to make the blade of a knife because metal \_\_\_\_\_

- (1) can reflect light
  - (2) does not break easily
  - (3) can bend without breaking
  - (4) does not allow light to pass through
8. Which of the following properties is true for both air and a pen?
- (1) They can be seen.
  - (2) They occupy space.
  - (3) They have fixed shapes.
  - (4) They have fixed volumes.
9. Object M was attracted to a magnet as shown in the diagram below.

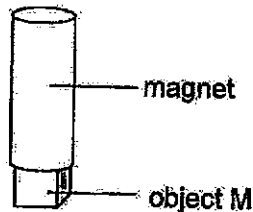

Object M could be made of \_\_\_\_\_

- (1) iron
- (2) wood
- (3) plastic
- (4) ceramic

10. Look at the picture below.

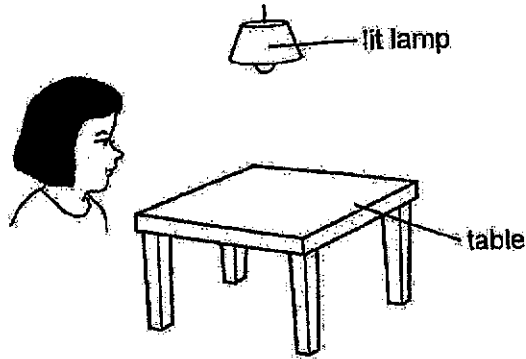

Which one of the following explains why Susan can see the table?



(1)

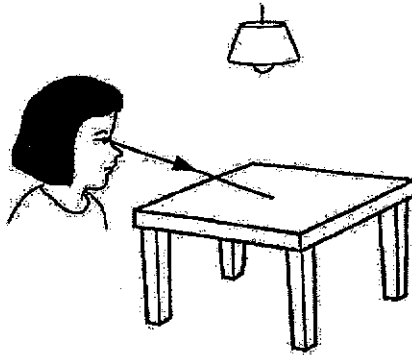

(2)

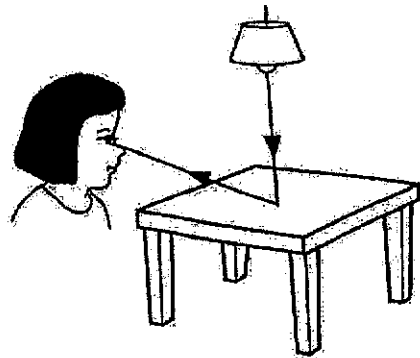

(3)

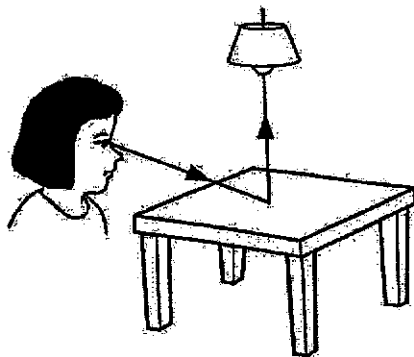

(4)

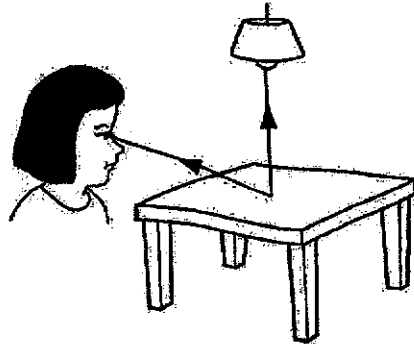

11. The table below shows the amount of undigested food as it exits various parts of the digestive system.

Part of the digestive system	Amount of undigested food as it exits the part of the digestive system (g)
W	90
X	50
Y	90
Z	10

One of the parts above is the stomach. Which part W, X, Y or Z could it be?

- (1) W
  - (2) X
  - (3) Y
  - (4) Z
12. Joe wanted to find out how the presence of leaves affect the amount of water taken in by the plants. He prepared two setups X and Y using the same type of plant as shown below.

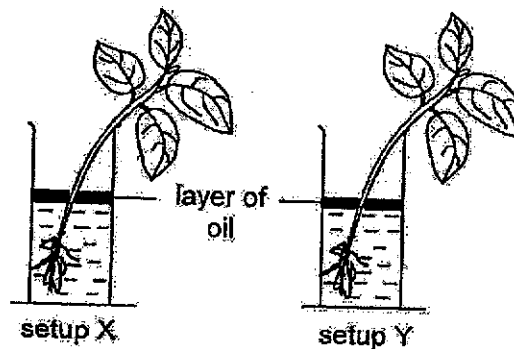

His teacher commented that he needed to make one change to ensure a fair test.

Which one of the following changes should he make?

- (1) Remove all the roots from the plant in setup Y.
- (2) Remove all the leaves from the plant in setup X.
- (3) Place setup X in the dark and setup Y in the garden.
- (4) Replace the plant in setup Y with one that has flowers.

13. Kate wanted to build a model of the human digestive system as shown below. She needed to choose a suitable material with a function similar to part P.

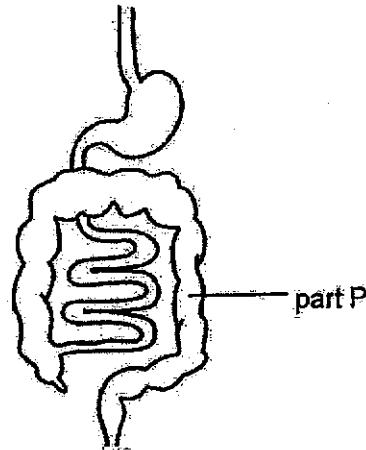

She set up an experiment to study two different materials C and D. She hung similar sized strips of each material on a stand and dipped one end of both strips in water. After 10 minutes, she observed the results as shown below.

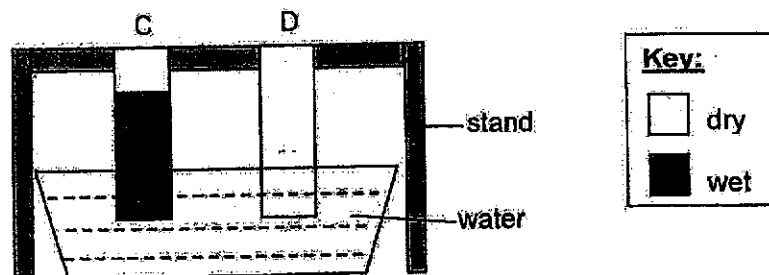

Based on the results above, which one of the following shows the correct reason why the material is more suitable to make part P of the human digestive system?

	Material	Reason
(1)	C	Material C absorbs water.
(2)	C	Material C is waterproof.
(3)	D	Material D absorbs water.
(4)	D	Material D is waterproof.

14. Mindy wanted to find out how surrounding temperature affects the height of the plant. Using the same type of plant, Mindy placed setup P by the window of a room with no air conditioner while setup Q by the window of a room with air-conditioner switched on.

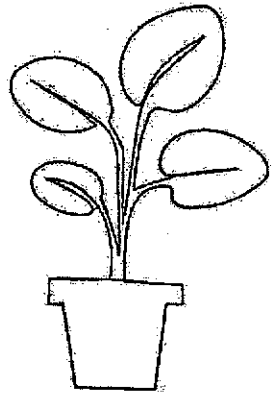

setup P  
(no air conditioner)

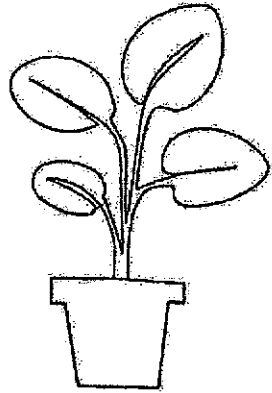

setup Q  
(with air conditioner switched on)

He measured the height of each plant over 14 days and recorded the results as shown.

Day	Height of plant (cm)	
	Setup P	Setup Q
0	10	10
2	11	11
4	14	12
6	17	13

Based on the information above, Mindy could conclude that \_\_\_\_\_.

- (1) plants with more leaves would grow taller
- (2) the higher the temperature, the taller the plant grew
- (3) the higher the temperature, the slower the plant can make food
- (4) the surrounding temperature does not affect the height of the plant

15. Four children made some statements about matter.

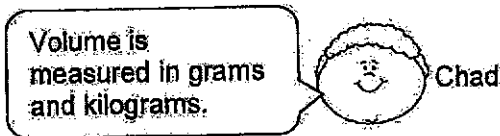
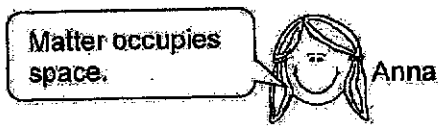

Whose statement(s) is/are not correct?

- (1) Anna only
- (2) Anna and Danny only
- (3) Belle and Chad only
- (4) Belle, Chad and Danny only

16. The diagrams below show two objects M and N placed in a measuring cylinder containing 40 cm<sup>3</sup> of water. The final water level after object M is removed is shown below.

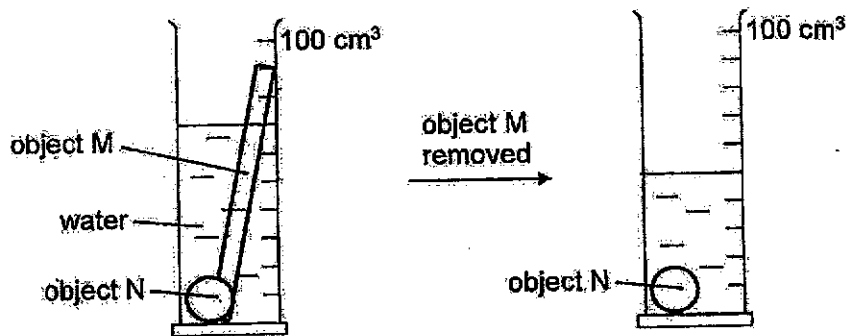

Which of the following shows the correct volumes of objects M and N?

	Volume of object M	Volume of object N
(1)	20 cm <sup>3</sup>	10 cm <sup>3</sup>
(2)	20 cm <sup>3</sup>	more than 10 cm <sup>3</sup>
(3)	more than 20 cm <sup>3</sup>	10 cm <sup>3</sup>
(4)	more than 20 cm <sup>3</sup>	more than 10 cm <sup>3</sup>

17. The three containers shown below have different volumes.  $30 \text{ cm}^3$  of substance Q is found to be able to occupy all the space in each container fully.

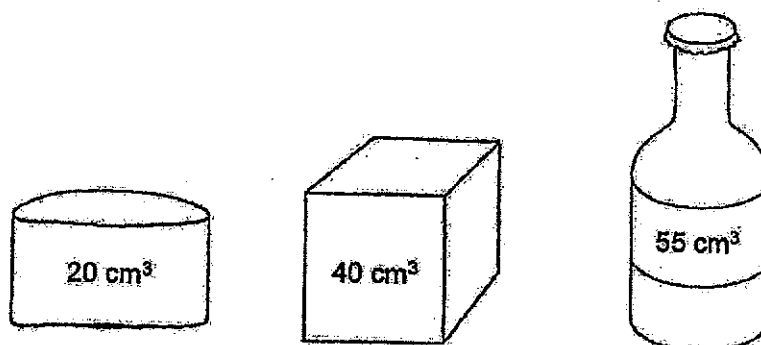

Based on the information above, what can be concluded about the volume and shape of substance Q?

	Volume	Shape
(1)	fixed	fixed
(2)	fixed	not fixed
(3)	not fixed	fixed
(4)	not fixed	not fixed

18. The table below describes four rings A, B, C and D.

Ring	Description
A	It is a magnet.
B	It is a magnet.
C	It is made of a magnetic material.
D	It is made of a non-magnetic material.

Based on the information above, which one of the following is definitely correct?

(1)

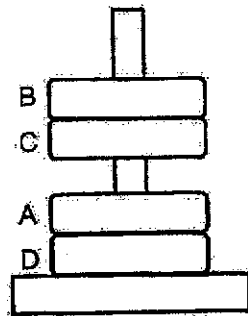

(2)

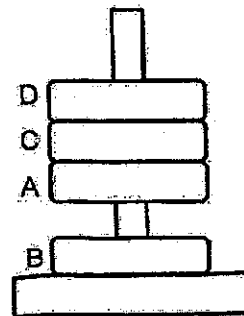

(3)

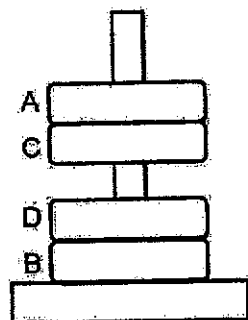

(4)

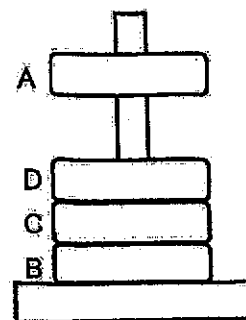

19. Henry observed four setups P, Q, R and S as shown below. Identical steel chips and iron nails were used in all setups. The number of steel chips attracted by each magnetised nail is shown below.

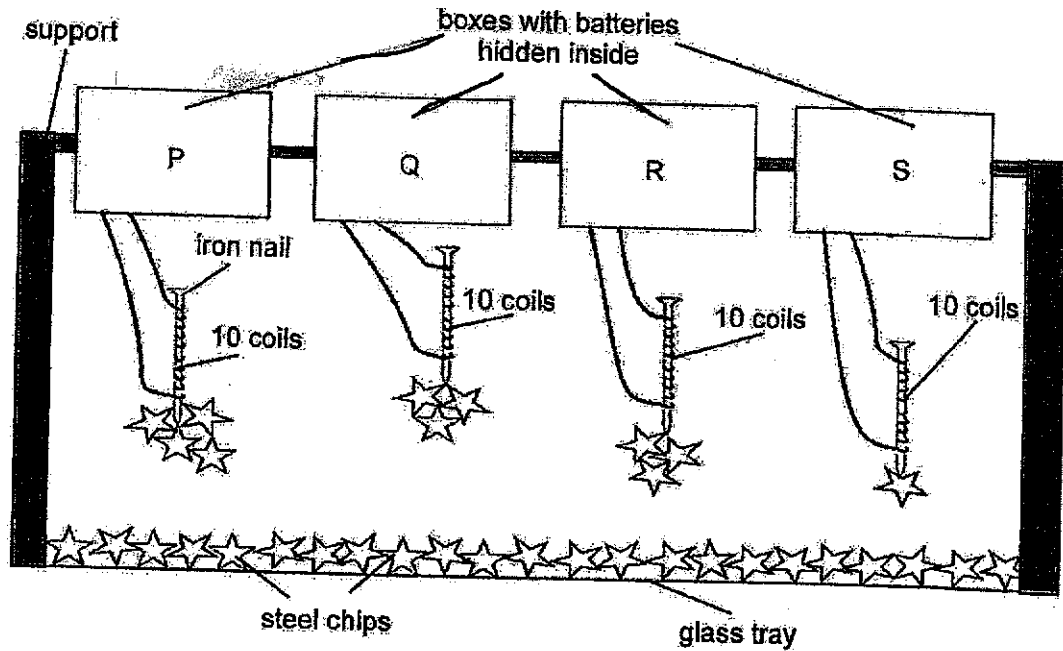

Based on the information above, which one of the following statements can be concluded from this experiment?

- (1) Setup Q has the most number of batteries.
- (2) Setup S has the least number of batteries.
- (3) Both setups P and S have the same number of batteries.
- (4) Both setups Q and R have the same number of batteries.

20. Feng Ming set up an experiment as shown below to measure the amount of light reflected from four materials W, X, Y and Z. A light sensor connected to a datalogger was used to measure the amount of light reflected by each material.

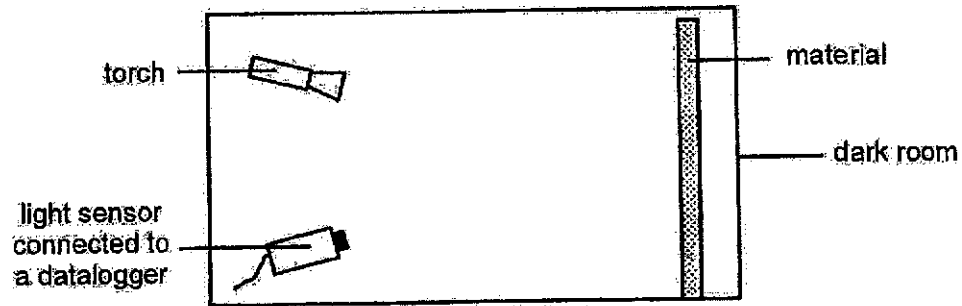

He recorded the readings in the table below. A greater reading shows a greater amount of light detected.

Material	Reading on datalogger (units)
W	150
X	50
Y	110
Z	300

Based on the results above, which of the following materials W, X, Y or Z is most suitable to make the wordings on the road sign as shown below?

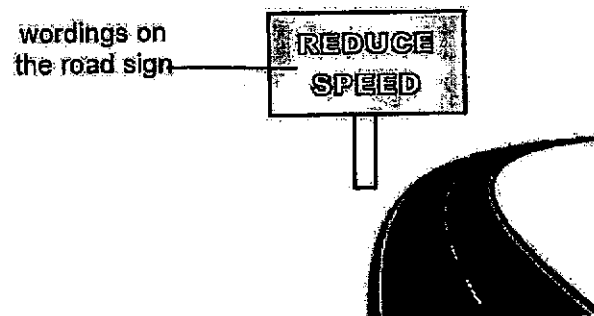

- (1) W
- (2) X
- (3) Y
- (4) Z

21. Paul conducted an experiment with cardboard shapes using the setup below.

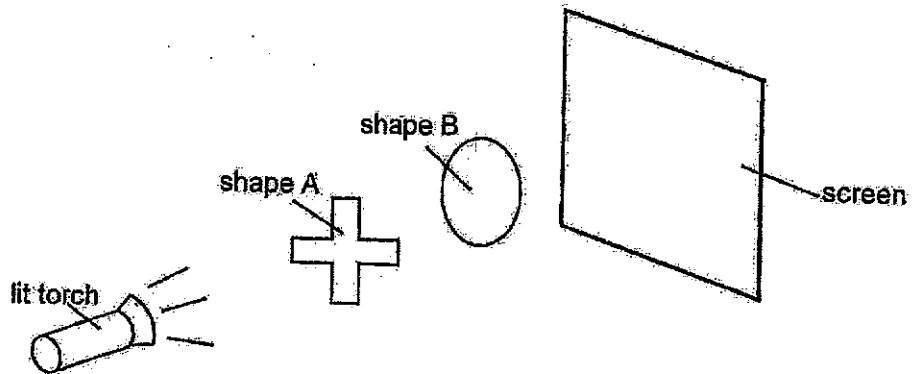

The dimensions of both shapes A and B are shown below.

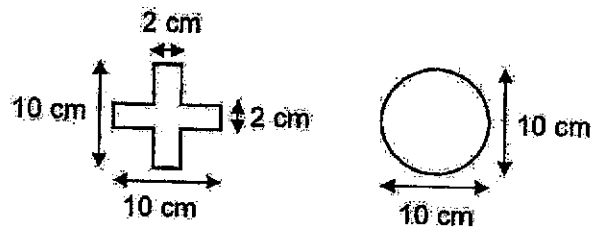

Which shadow would Paul see on the screen?

(1)



(2)



(3)



(4)



22. Janelle placed a lit torch at point P of a ruler. She shone the torch on a wooden object that was placed at point R. A shadow of the object was cast on the screen at point T.

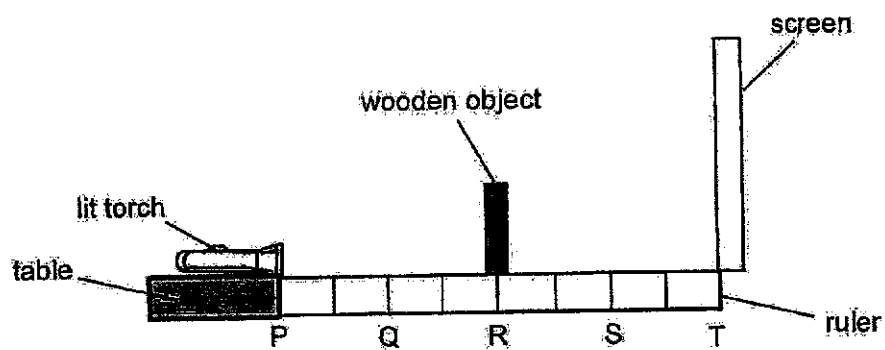

Without changing the position of the torch, which one of the following would result in the largest shadow formed on the screen?

- (1) move the object to Q
- (2) move the object to S
- (3) move object to Q and screen to R
- (4) move the screen to R and object to T

23. The diagram below shows a man walking on a street at night from position A to position D.

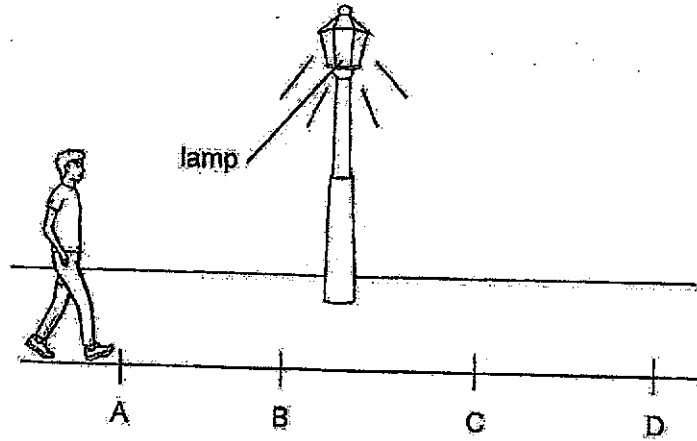

At which of these positions would the shadow of the man be the shortest?

- (1) A
  - (2) B
  - (3) C
  - (4) D
24. Joy poured some cold water into a glass. She then held the glass of water immediately after pouring.

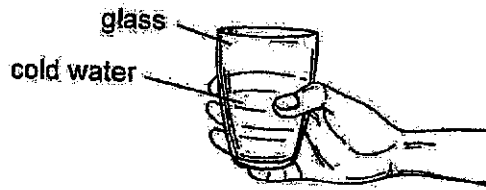

Based on the information above, Joy's hand felt cold because her hand \_\_\_\_\_.

- (1) lost heat to the glass
- (2) gained heat from the glass
- (3) gained heat from the water
- (4) lost heat to the surrounding air

25. Mia set up the experiment shown below. The four rods A, B, C and D are made of different materials but of the same length and thickness. At the end of each rod, an identical thumbtack was attached to each rod using the same amount of wax. Wax would melt when it gained heat, causing the thumbtack on each rod to drop.

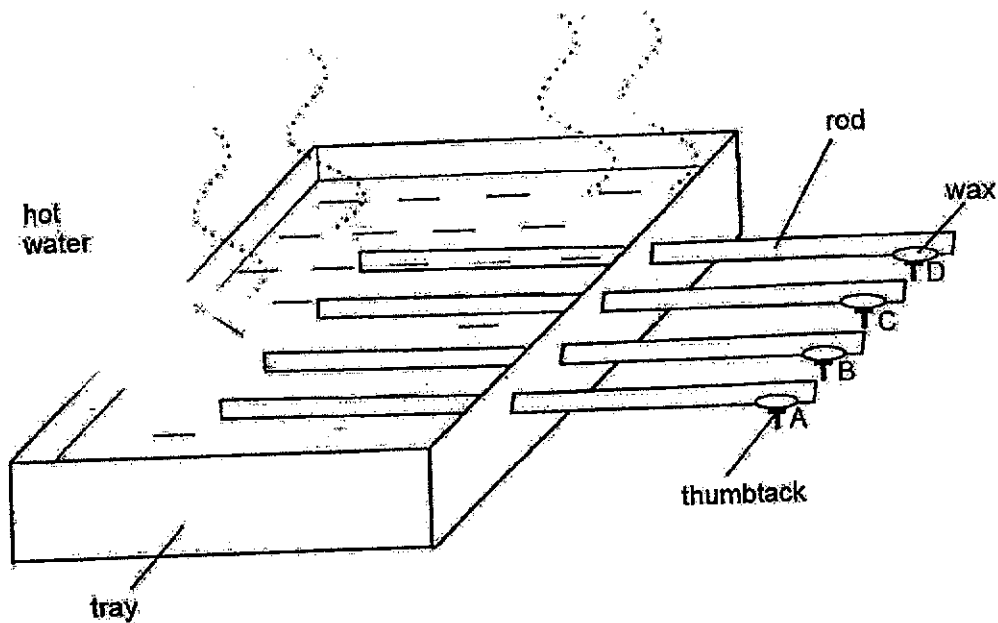

The time taken for each thumbtack to drop was recorded below.

Thumbtack on rod	Time taken for thumbtack to drop (min)
A	5
B	12
C	7
D	2

Based on the information above, mia concluded that rod \_\_\_\_\_.

- (1) A is definitely made of plastic
- (2) B is the best conductor of heat
- (3) C is a poorer conductor of heat than B
- (4) D is a better conductor of heat than A

26. Roy placed a tray of hot cake at  $90^{\circ}\text{C}$  on a table at a room temperature of  $30^{\circ}\text{C}$ .

Which one of the following shows the correct graph of the temperature of cake for a period of 5 hours?

(1)

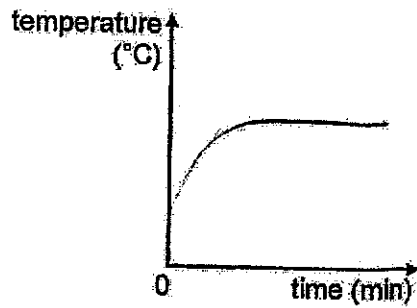

(2)

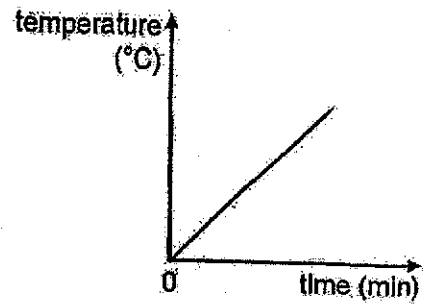

(3)

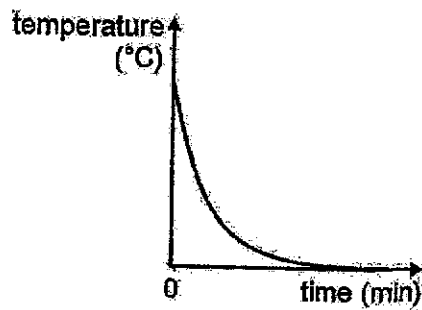

(4)

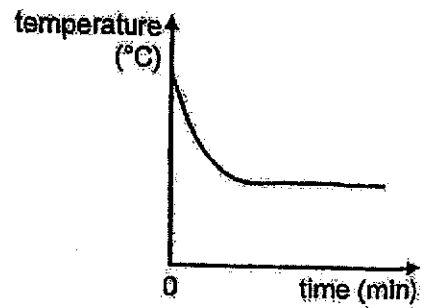

27. A drop of ink is placed in a glass tube connecting two similar beakers A and B as shown below. Each flask is placed in a beaker of water.

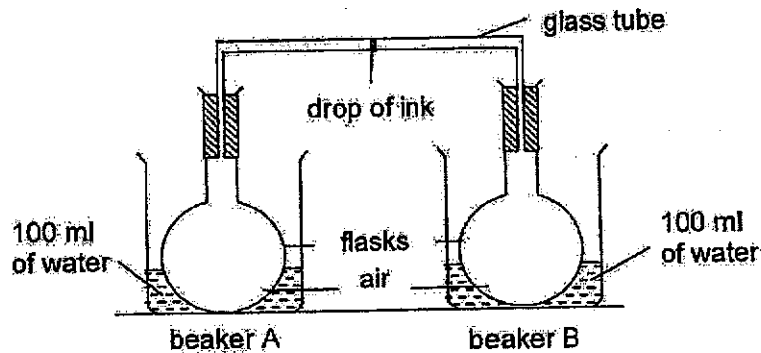

Which one of the following would cause the drop of ink to move towards beaker A?

- (1) put ice in beaker B
  - (2) put ice in both beakers
  - (3) heat up the water in beaker B
  - (4) heat up the water in both beakers
28. The diagram below shows three similar setups L, M and N heated by different number of heat sources. They contained the same amount of water at 30°C at the start.

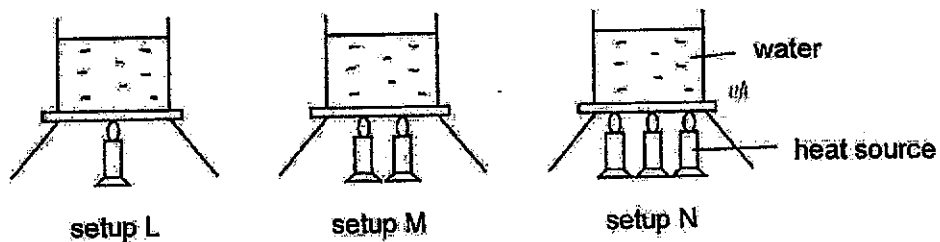

Based on the information above, which one of the following statements is correct?

- (1) The water in setup L would boil first.
- (2) The water in setup M would boil before setup L.
- (3) The water in setup N gained heat from the heat source the slowest.
- (4) At the start of the experiment, the water in setup N had the most amount of heat.

End of Booklet A

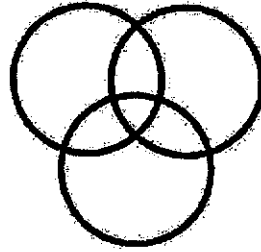

Founded 1947

南侨小学

NAN CHIAU PRIMARY SCHOOL  
END YEAR EXAMINATION

2024

SCIENCE  
PRIMARY 4  
BOOKLET B

Name / Index no.	Chua Ke Yang Enzo	( )
Class	Primary 4	
Date	21 October 2024	
Duration for Booklets A and B	1 h 45 min	
Marks	Booklet B	44
Parent's Signature		
Instructions to students	<ol style="list-style-type: none"> <li>1. Do not turn over this page until you are told to do so.</li> <li>2. Follow all instructions carefully.</li> <li>3. Answer all questions.</li> <li>4. Use a dark blue or black ballpoint pen to write your answers in the space provided for each question.</li> <li>5. Do not use correction fluid/tape or highlighters.</li> </ol>	

This paper consists of 18 pages altogether.

**BLANK PAGE**

For questions 29 to 41, write your answers in this booklet.  
 The number of marks available is shown in [ ] at the end of each question or part question.

[44 marks]

29. The diagram below shows a photo frame.

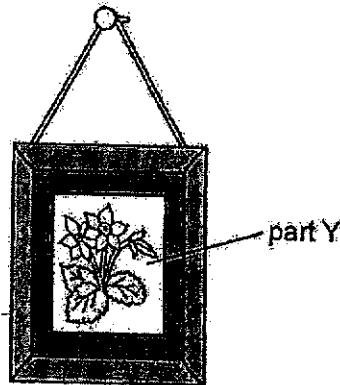

Fill in the blanks using the correct words in the box.

heat	bends	breaks
light	glass	iron

Part Y of the photo frame is made of \_\_\_\_\_ because it  
 allows \_\_\_\_\_ to pass through so that the person can see the  
 picture. However, part Y \_\_\_\_\_ easily when dropped.

[3]

SCORE	3
-------	---

30. Classify the following into matter and non-matter.

air	light	shadow
-----	-------	--------

Matter	Non-matter

[3]

31. Two magnets are placed together as shown below.

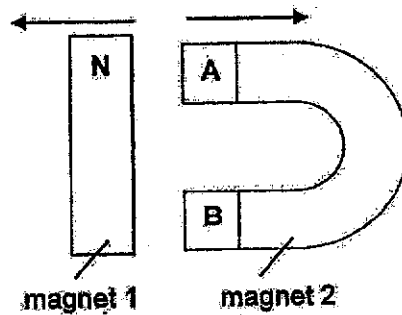

The north pole of magnet 1 is labelled N.

Name the poles labelled A and B on magnet 2.

[2]

(i) A: \_\_\_\_\_

(ii) B: \_\_\_\_\_

32. Look at the pictures. Tick (✓) the sources of light.

[2]

the Sun

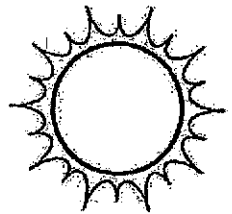

mirror

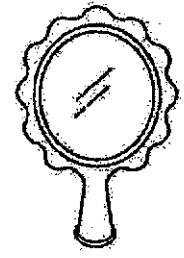

lamp



eyes

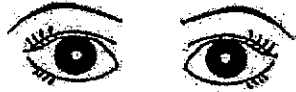

SCORE	2
-------	---

33. Read the statements in the table below carefully.  
Fill in the boxes with "T" if it is true or "F" if it is false.

[2]

	Statement	T / F
(i)	Fungi can be useful or harmful to us.	
(ii)	Bacteria and mould are some examples of fungi.	
(iii)	All fungi are microorganisms.	
(iv)	All bacteria are harmful.	

SCORE	2
-------	---

34. The table below shows the characteristics of three animals F, G and H.

Characteristic	Animal		
	F	G	H
The adult can fly.	yes	no	yes
The young looks like the adult.	yes	yes	no
The adult has three body parts.	no	no	yes
The adult has six legs.	no	no	yes
The adult lays eggs.	no	no	yes

- (a) Based on the characteristics of insects and the table above, which animal F, G or H would most likely represent a mosquito? Explain why.

[2]

---



---



---

- (b) Based on the table above, can animal G represent a frog? Explain your answer.

[2]

---



---



---

35. Celeste observed plant W which needs a support to grow upwards as shown below.

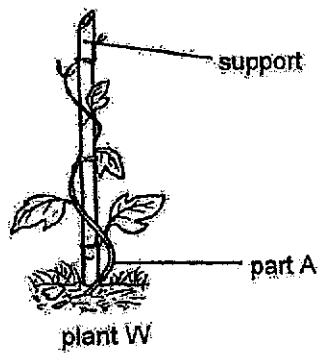

(a) Based on the diagram above, state the characteristic of part A. [1]

Celeste conducted an experiment with two similar plants X and Y. Only the roots of plant Y were wrapped in a plastic bag as shown below.

Celeste placed both plants in the garden and watered them daily with the same amount of water.

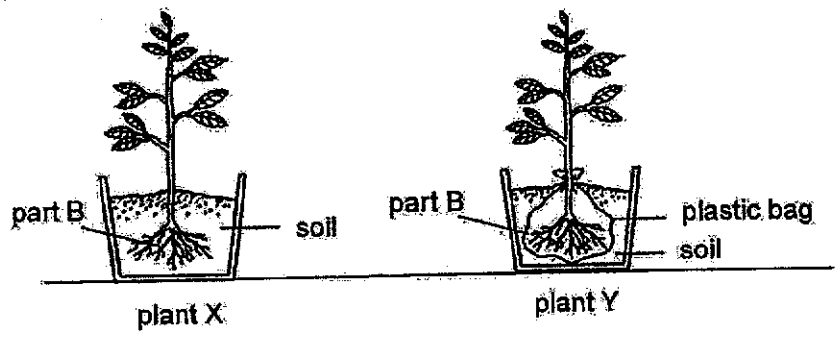

(b) Celeste noticed that plant Y died after a week. Explain why. [1]

---

---

Please continue question 35 on the next page.

- (c) Explain why Celeste placed both plants X and Y in the garden to ensure a fair test. [1]

---

Celeste prepared another setup using plant Z as shown below. She painted all the leaves black.

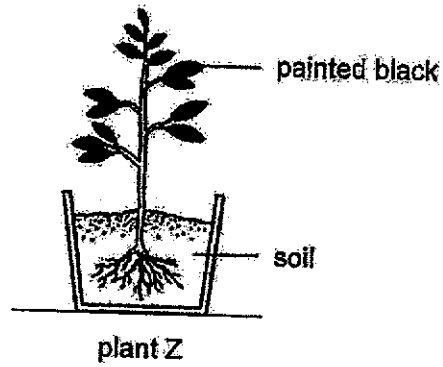

- (d) Celeste noticed that plant Z died after a week. Explain why. [1]

---

---

SCORE	4
-------	---

36. Tim put 10 units of food into his mouth and chewed it for 40 seconds before swallowing it. The graph below shows the amount of digested food in Tim's mouth.

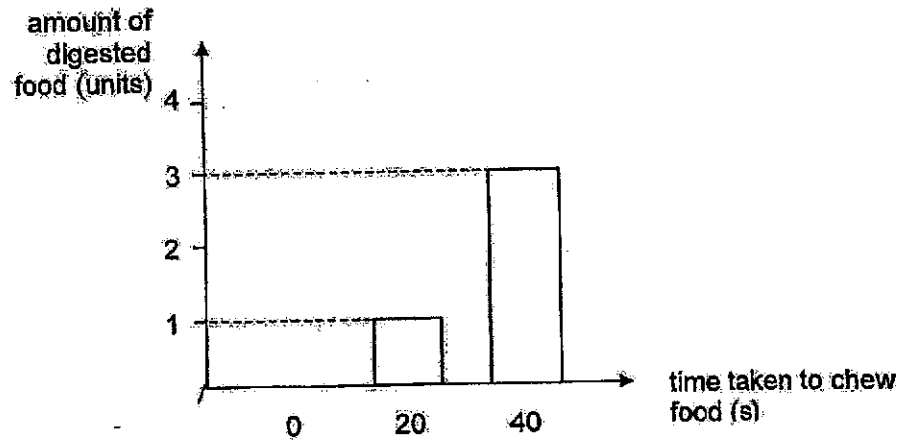

- (a) State what digestion is.

[1]

---



---

- (b) Based on the graph above, state the relationship between the amount of digested food and the time taken for him to chew the food.

[1]

---



---

*Please continue question 36 on the next page.*

- (c) Tim took another 10 units of food and cut it into smaller pieces before putting it into his mouth. He chewed the food for 40 seconds before swallowing it.

Based on the information and the graph above, state whether the amount of digested food in his mouth after 40 seconds would be more or less than 3 units. Explain your answer.

[2]

---

---

---

SCORE	4
-------	---

37. Arif carried out an experiment to find out if the type of wood used would affect the strength of the wooden plank as shown below. He placed identical blocks, one at a time, on wooden plank A until it broke.

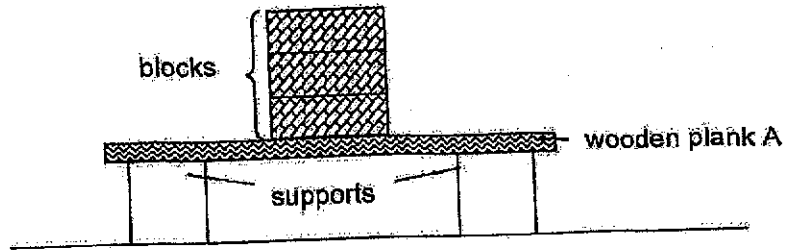

He repeated the experiment with three other types of wooden planks B, C and D.

He recorded the number of blocks that each wooden plank was able to hold before it broke and presented his results on the graph below.

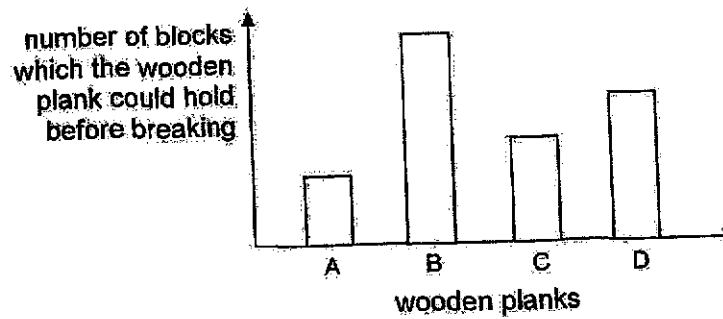

- (a) Put a tick (✓) in the box(es) below, to indicate the variable(s) that Arif must keep the same to ensure a fair test. [4]

Variable	To be kept the same
Type of wood used	
Thickness of each wooden plank	

*Please continue question 37 on the next page.*

Arif wanted to make a surfboard to surf at sea as shown below.

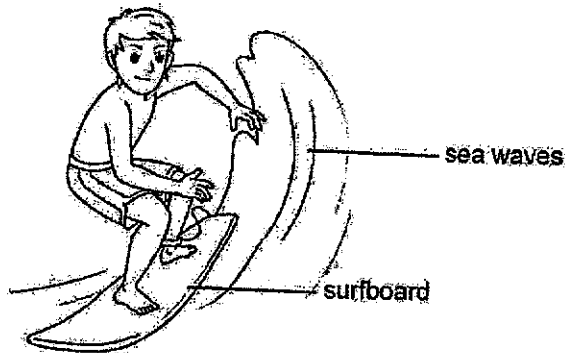

- (b) Based on the results of Arif's experiment, which plank A, B, C or D would be most suitable to make the surfboard? Explain your answer.

[1]

---



---

- (c) Besides the property of the wooden plank tested in Arif's experiment as well as being able to float on water, state two other properties which the wooden plank must have to make the surfboard.

[2]

(i) \_\_\_\_\_

(ii) \_\_\_\_\_

SCORE	4
-------	---

38. Samantha placed a funnel at the mouth of bottle P as shown below. She then poured 500 ml of oil from a jug into bottle P.

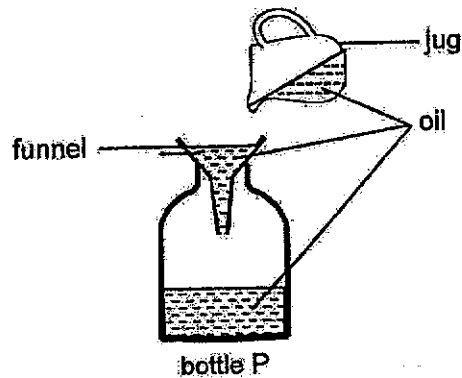

- (a) Samantha observed that the oil flowed into bottle P very slowly and then stopped flowing after some time. Explain her observation. [2]

---

---

---

- (b) Using the same apparatus and without breaking bottle P, what could Samantha do to make the oil flow faster into the bottle? [1]

---

*Please continue question 38 on the next page.*

Samantha filled a vase with water up to level L before putting in some stalks of flowers.

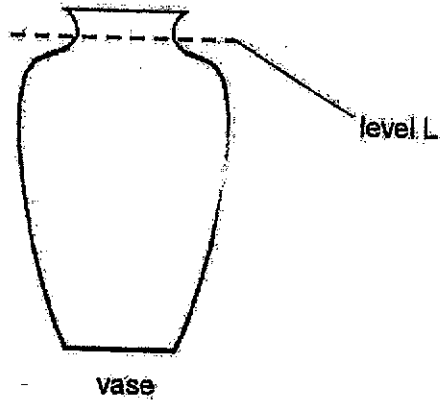

(c) When Samantha placed a bouquet of flowers in the vase, the water overflowed. Give a reason why the water overflowed.

[1]

---

---

SCORE	4
-------	---

39. Emma made a game using the objects shown below. One pole of magnet P was brought close to each of the two bars A and B.

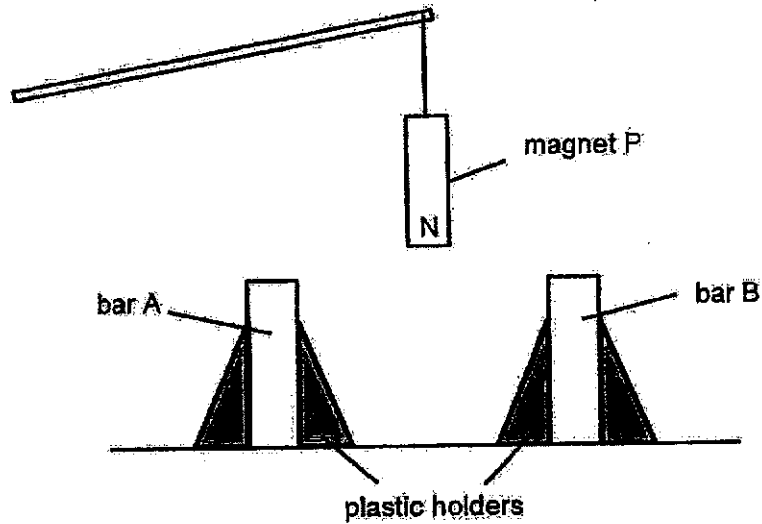

- (a) Magnet P could pick up both bars A and B. Emma was told that only one of the two bars is a magnet.

Without adding any additional object to the game, what could Emma do to determine whether bar B is a magnet? [2]

---



---

Plastic holders instead of steel holders were used in the game.

- (b) Give a reason why steel holders were not used in this game. [2]

---



---

40. Lisa set up an experiment by placing a glass bottle containing water at 80°C into the container. She also placed material A in the container as shown below.

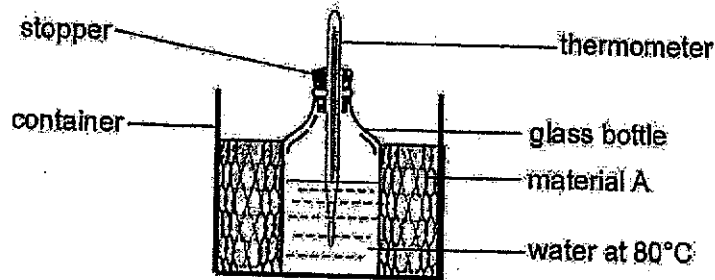

She recorded the time taken for the temperature of the water in the glass bottle to drop to 60°C. She repeated the experiment by using two different materials B and C, one at a time. Her results are shown below.

Material	Time taken for water to drop to 60°C (min)
A	20
B	35
C	15

- (a) Which of the three materials A, B or C is the best conductor of heat? Explain why. [2]

---



---



---

- (b) Lisa wants to make gloves that can be used to hold the hot baking tray from the oven. Based on her experiment, which of the materials A, B or C should she use? Give a reason for your choice. [2]

---



---



---

41. Ben wanted to test the transparency of materials. He carried out an experiment below in a dark room. He arranged four sheets A, B, C and D as shown below.

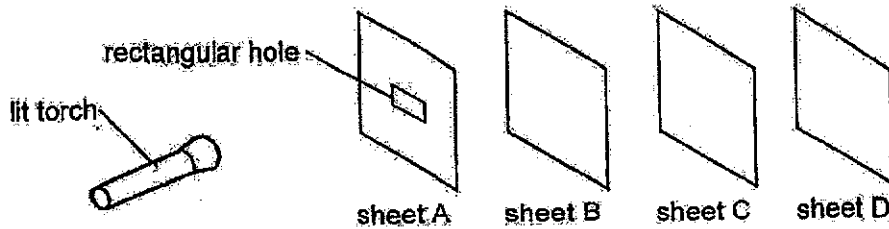

When the torch is switched on, a bright rectangular patch of light is seen on sheet C only.

- (a) Why was Ben not able to see the bright rectangular patch of light on sheet D? [1]

---



---

- (b) When sheet C was removed, the bright rectangular patch was still not seen on sheet D. What could Ben conclude about the transparency of sheet D? [1]

---



---

*Please continue question 41 on the next page.*

(c) Explain why the experiment was conducted in a dark room.

[1]

---

---

(d) Identify one variable that Ben had to keep the same to ensure a fair test.

[1]

---

**End of Paper**

SCORE	4
-------	---



SCHOOL : NAN CHIAU PRIMARY SCHOOL

LEVEL : PRIMARY 4

SUBJECT : SCIENCE

TERM : 2024 SA2

---

Q1	Q2	Q3	Q4	Q5	Q6	Q7	Q8	Q9	Q10
4	3	4	4	1	4	2	2	1	2

Q11	Q12	Q13	Q14	Q15	Q16	Q17	Q18	Q19	Q20
2	2	4	2	4	1	4	2	2	4

Q21	Q22	Q23	Q24	Q25	Q26	Q27	Q28
4	1	2	1	4	4	3	2

**Nan Chiau Primary School**  
**Primary 4 Science**  
**End Year Examination 2024**  
**Booklet B (Answer Key)**

Name: \_\_\_\_\_ (       )

Class: \_\_\_\_\_

29	<input type="checkbox"/> glass. <input type="checkbox"/> light <input type="checkbox"/> breaks						
30	<table border="1" style="width: 100%; text-align: center;"> <thead> <tr> <th style="width: 50%;">Matter</th> <th style="width: 50%;">Non-matter</th> </tr> </thead> <tbody> <tr> <td><input type="checkbox"/> air</td> <td><input type="checkbox"/> light</td> </tr> <tr> <td></td> <td><input type="checkbox"/> shadow</td> </tr> </tbody> </table>	Matter	Non-matter	<input type="checkbox"/> air	<input type="checkbox"/> light		<input type="checkbox"/> shadow
Matter	Non-matter						
<input type="checkbox"/> air	<input type="checkbox"/> light						
	<input type="checkbox"/> shadow						
31	(i) A: <input type="checkbox"/> North (ii) B: <input type="checkbox"/> South						
32	<input type="checkbox"/> The Sun <input type="checkbox"/> Lamp						
33	(i) <input type="checkbox"/> True (ii) <input type="checkbox"/> False (iii) <input type="checkbox"/> False (iv) <input type="checkbox"/> False						
34(a)	<input type="checkbox"/> H. <sup>[E1 and R1]</sup> H has adult with three body parts just like a mosquito. <sup>[E2 and R2]</sup> H has six legs just like an insect.						
(b)	<input type="checkbox"/> No. <sup>[E1]</sup> The young of G looks like the adult but <sup>[R1]</sup> the young of a frog does not look like the adult. <sup>[E2]</sup> G does not lay egg in water but <sup>[R2]</sup> the frog lays eggs in water.						
35(a)	<input type="checkbox"/> Weak stem.						
(b)	<input type="checkbox"/> The roots were wrapped in a plastic bag. <sup>[R]</sup> The roots could not absorb water.						
(c)	<input type="checkbox"/> This is to ensure that X and Y could receive the same amount of sunlight.						
(d)	<input type="checkbox"/> The leaves were painted black. <sup>[R1]</sup> The leaves could not trap light <sup>[R2]</sup> to make food.						
36(a)	<input type="checkbox"/> Digestion is the breaking down of food into simple substances.						
(b)	<input type="checkbox"/> <sup>[E1]</sup> As the time taken to chew the food increases, the amount of digested food also increases.						

(c)	[C] More. Cutting the food into smaller pieces would [R1] increase the surface area of the food in contact with the digestive juice in the mouth. [R2] The food would be partially digested faster.						
37(a)	<table border="1"> <thead> <tr> <th>Variables</th> <th>To be kept the same</th> </tr> </thead> <tbody> <tr> <td>Type of wood used</td> <td></td> </tr> <tr> <td>Thickness of each wooden plank</td> <td>✓</td> </tr> </tbody> </table>	Variables	To be kept the same	Type of wood used		Thickness of each wooden plank	✓
Variables	To be kept the same						
Type of wood used							
Thickness of each wooden plank	✓						
(b)	[C] Plank B. [E] B could hold the greatest number of blocks before breaking. [R] B is the strongest material.						
(c)	(i) [C] Not flexible. (ii) [C] Waterproof.						
38(a)	[R1] The air in the bottle occupies space. [R2] Air in the bottle could not be compressed any further.						
(b)	[C] Lift the funnel up when pouring.						
(c)	[R1] The flowers occupy space. [R2] There is not enough space in the vase.						
39(a)	[C] Bring the South pole of magnet P close to the same end of bar B. [R] If the magnet is repelled, bar B is a magnet.						
(b)	[R1] Steel is magnetic. [R2] It is not used so that the magnet would not attract the steel holders.						
40(a)	[C] Material C; [E] With C, the water took the shortest time for the temperature of water to drop to 60°C. [R] Heat is transferred from the water to C the fastest.						
(b)	[C] Material B; [E] With B, the water took the longest time for the temperature to drop to 60°C. [R] B is the poorest conductor of heat.						
41(a)	[R] Sheet C does not allow light to pass through.						
(b)	[R] Sheet D allows most light to pass through.						
(c)	[C] This is to ensure that there is only one light source, which is the lit torch.						
(d)	[C] Same torch used.						

End of answer key

