

NANYANG PRIMARY SCHOOL
Term 2 Weighted Assessment
Science
Primary 4



Name: _____ () Date: _____

Class: 4 _____ Parent's signature: _____

Dear Parent/Guardian,

Please sign the Weighted Assessment paper and have your child/ward return it the next day. Any query should be raised at the same time when returning the paper.

Section A: Multiple Choice Questions (10 marks)

For each question from 1 to 5, four options (1, 2, 3 and 4) are given. One of them is the correct answer. Indicate your choice in the brackets provided.

1. Which statement about light is incorrect?
- (1) Light is a form of energy.
 - (2) Light travels in a straight line.
 - (3) A shadow is formed because light is reflected.
 - (4) A table can be seen because it reflects light into our eyes.

()

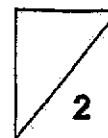

2. A metal pole and a torch were placed on a table as shown in the diagram below.

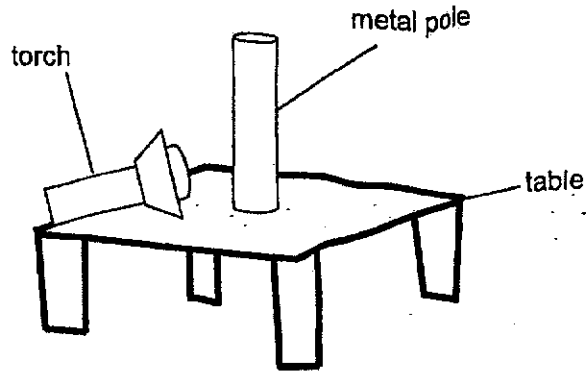

Which of the following diagrams correctly shows the shadow of the pole on the table top?

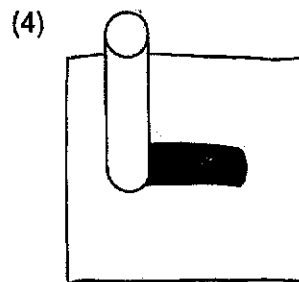
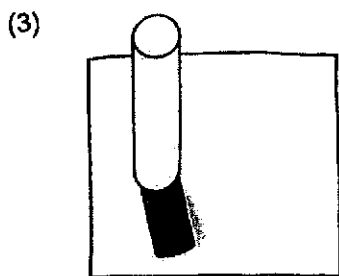
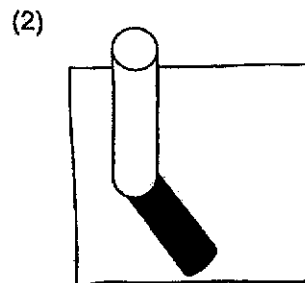
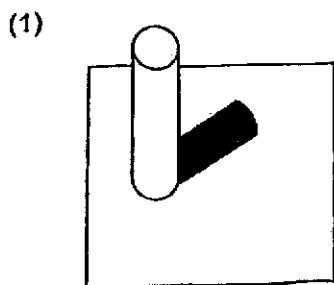

()

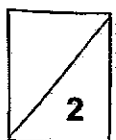

3. Mary set up an experiment using a light sensor to measure the amount of light passing through different materials. The set-up shown below is placed in a dark room.

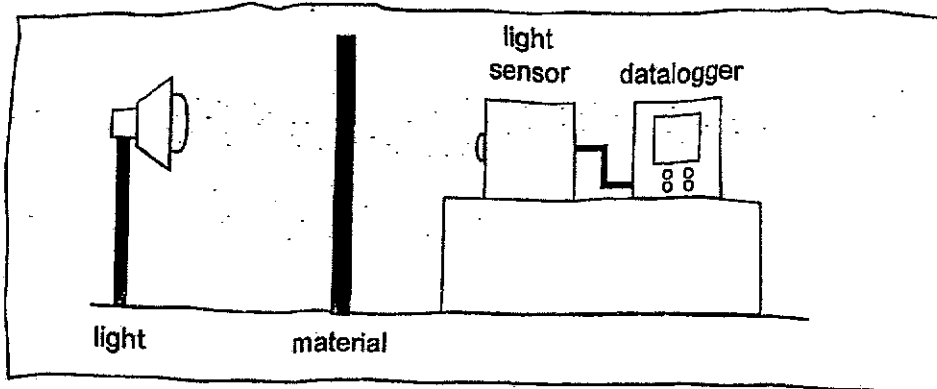

She measured the amount of light passing through materials P, Q and R. The table below shows the recorded results on the datalogger.

Material	Amount of light detected (units)
P	100
Q	40
R	0

Which of the following best represents materials P, Q and R?

	Material P	Material Q	Material R
(1)	clear plastic	cardboard	paper
(2)	cardboard	paper	clear plastic
(3)	clear plastic	paper	cardboard
(4)	paper	cardboard	clear plastic

()

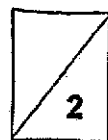

4. Which of the following statements about the plant parts is correct?

	Stem	Leaf	Roots
(1)	Holds the plant upright	Takes in and give out gases	Hold the plant firmly to the ground
(2)	Holds the plant firmly to the ground	Makes food for the plant	Hold the plant upright to reach for light
(3)	Holds the plant upright	Absorbs mineral salts and water	Take in and give out gases
(4)	Takes in and give out gases	Makes food for the plant	Hold the plant firmly to the ground

()

5. Jane grew a plant shown in the diagram below. She placed it in a box with a small opening. A few days after the plant has been placed in the box, it was observed to lean towards the opening of the box.

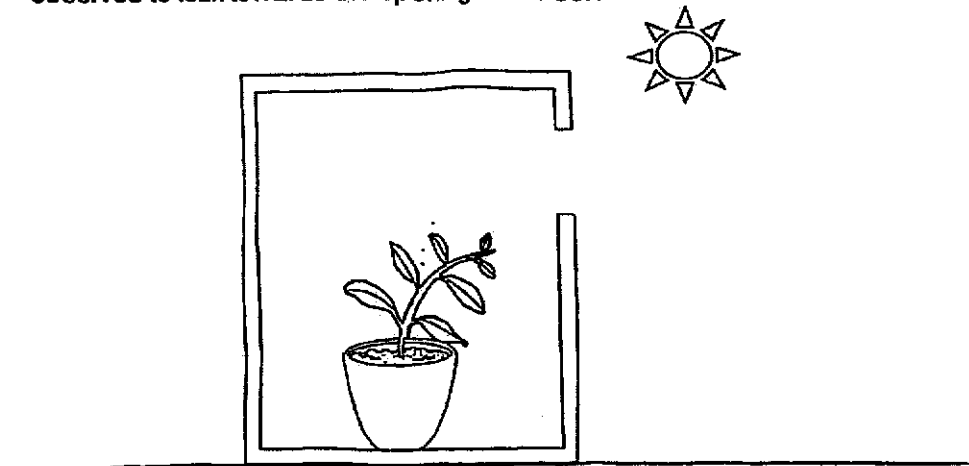

Based on the diagram, which of the following statements is correct?

- (1) The plant bends to absorb more water.
- (2) The plant bends as it has a weak stem.
- (3) The plant bends due to a lack of space.
- (4) The plant bends to grow towards the light.

()



Section B: Open-Ended Questions (5 marks)

For questions 6 and 7, fill in your answers in the spaces provided.

6. The set-up below is used to investigate how distance between the light source and object X will affect the height of the shadow cast.

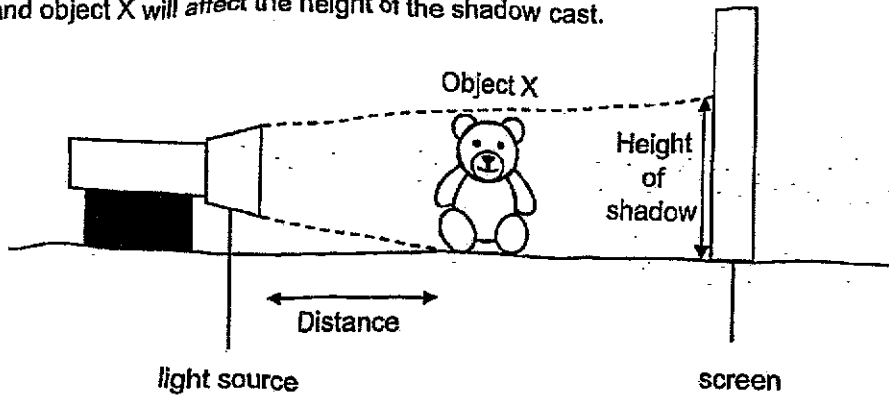

The distance between object X and the light source was changed a few times and the height of the shadow was measured and recorded in the table shown below.

Distance between object X and the light source (cm)	Height of shadow (cm)
5	25
13	17
20	10
25	z

- (a) Based on the results above, state a possible value for z. [1]
 _____ cm
- (b) Based on the aim of the experiment, state the changed variable. [1]

- (c) Based on the results, what is the relationship between the distance between object X and the light source and the height of the shadow? [1]

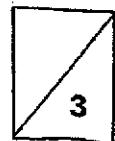

7. Benjamin set up an experiment using the following set-ups, X, Y and Z as shown in the diagram below.

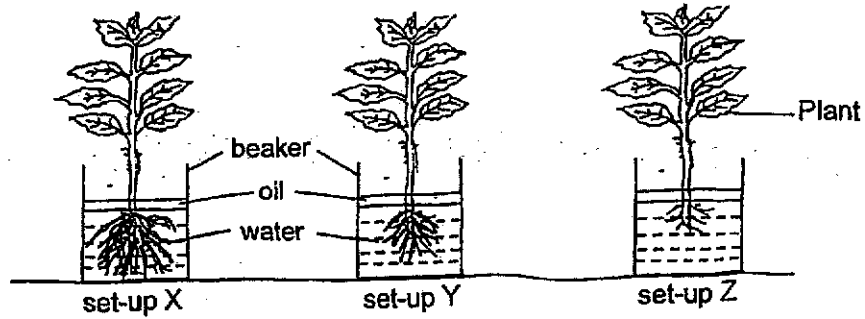

He used the same type of plant in each set-up and gave the same amount of water at the start of the experiment. After two days, he realised that the amount of water in each setup was different.

(a) In which set-up will there be the most amount of water left in the beaker? [1]

(b) Explain your answer in (a). [1]

End of Paper -

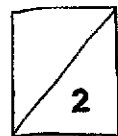

Nanyang Primary School
P4 SCIENCE WA2 2024
Students' Answer Key

Section A

1	3
2	Void
3	3
4	1
5	4

Section B

Qn No	Acceptable Answers
6a.	1cm to 10cm
6b.	Distance between object X and the light source
6c.	The further the distance between object X and the light source, the shorter the height of the shadow.
7a.	z
7b.	Z had the least amount of roots which will absorb the least amount of water.

