



Nan Hua Primary School
Primary 4 Science
Term 3 Weighted Assessment 2024

Marks	
Section A:	/10
Section B:	/10
Total:	/20

Name: _____ ()

Class: Primary 4/ _____

Date: _____

Duration: 30 minutes

Parent's Signature _____

Answer all questions.

Section A: (5 x 2 marks = 10 marks)

For each question from 1 to 5, four options are given. One of them is the correct answer. Make your choice (1, 2, 3 or 4) and write your answer in the brackets provided.

1 Which of the following is a source of light?

(1)

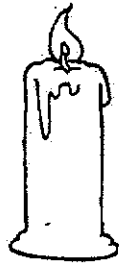

lighted candle

(2)



moon

(3)

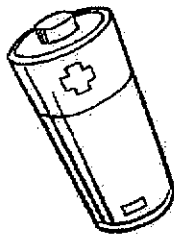

battery

(4)



mirror

()

(Go on to the next page)

This booklet consists of 8 printed pages.

2 The diagram below shows a teacup.



Which of the following shadows cannot be formed by the teacup?

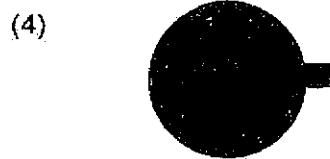
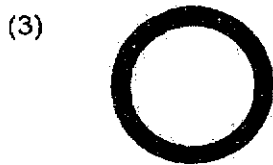

3 Hayley used a hollow wooden roll to look through a marble as shown in the diagram below.

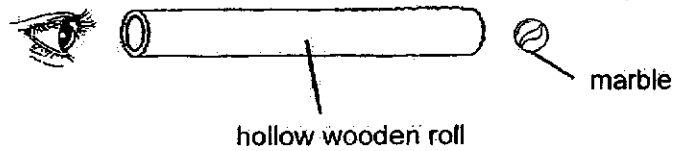

Why was Hayley able to see the marble through the hollow wooden roll?

- A Light is reflected away from her eye.
- B Light given out by the marble enters her eye.
- C Light reflected by the marble enters her eye.

- (1) B only
- (2) C only
- (3) A and B only
- (4) A and C only

()

4 The diagram below shows a boy walking on the street at night.

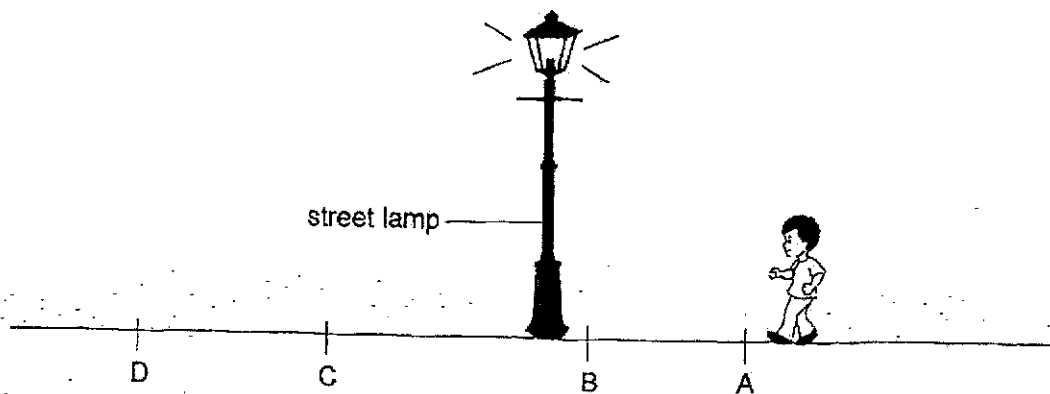

Which of the following graphs shows how the length of the boy's shadow changes from points A to D under the lit street lamp?

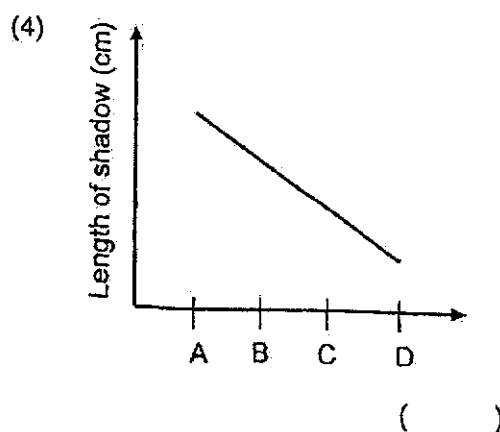
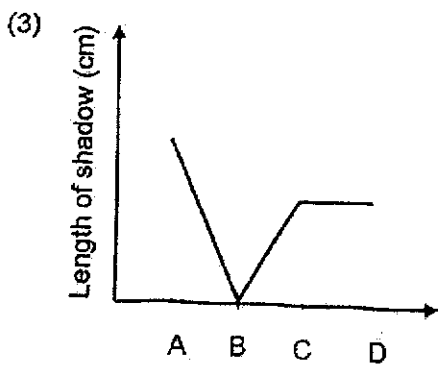
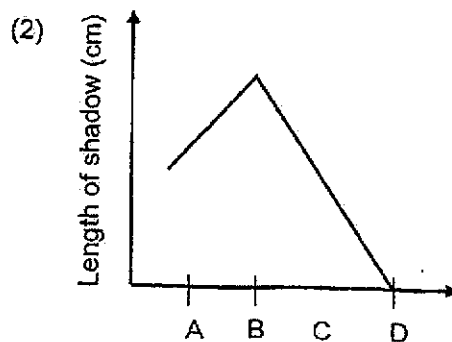
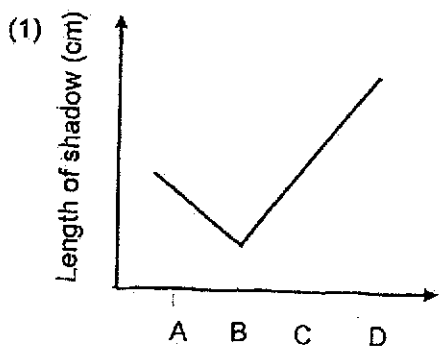

- 5 The set-up below shows light shining on three wooden objects, A, B and C. They are placed at different distances from the torch.

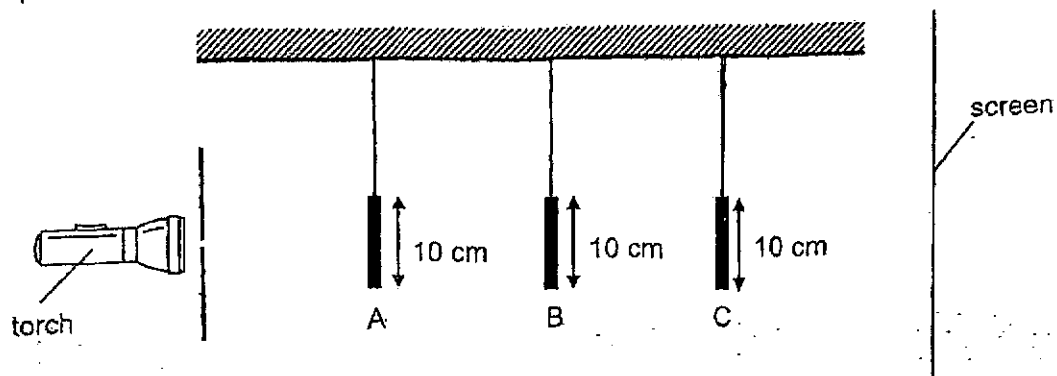

The diagram below shows the shadow of the objects formed on the screen.

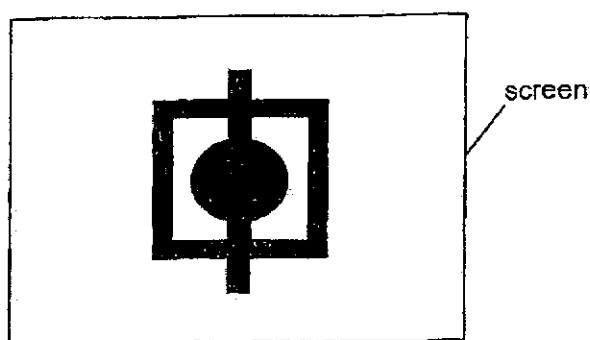

What are objects A, B and C?

	A	B	C
(1)		□	●
(2)	□	●	
(3)	●		□
(4)	●	□	

()

Total score for Section A	10
------------------------------	----

Section B: Structured questions (10 marks)

For questions 6 to 8, write your answers in the space provided. The number of marks available is shown in brackets [] at the end of each question or part question.

- 6 The diagram shows a girl using a torch to see a cat in front of her.

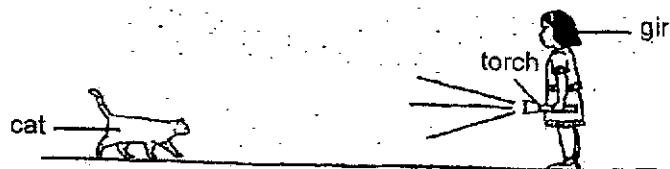

- (a) Using a ruler and a pencil, draw one more line and two arrows in the diagram below to correctly show the path of light so that the girl can see the cat. [2]

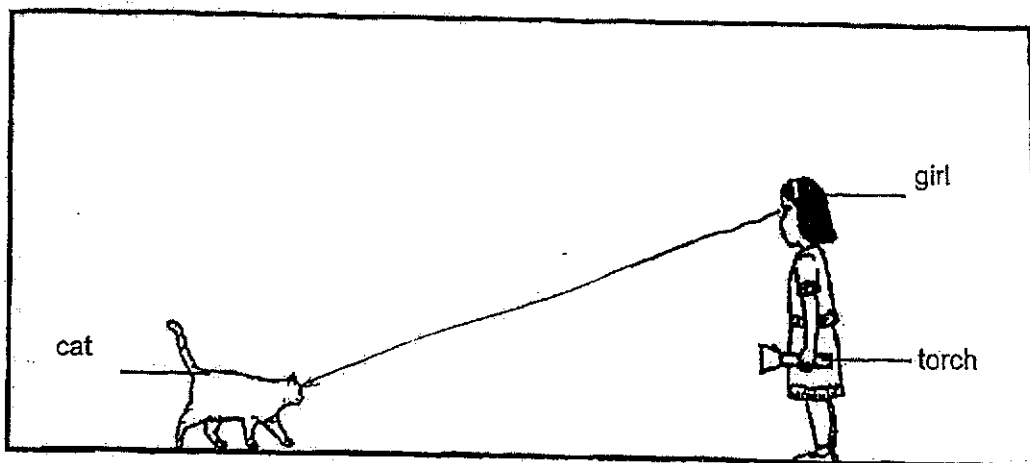

- (b) State a property of light that is shown from your drawing. [1]

(Go on to the next page)

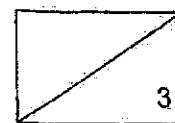

- 7 An experiment was conducted in a dark room. The diagram below shows the set-up to find out the amount of light that can pass through two types of materials, Q and R, of the same thickness and length.

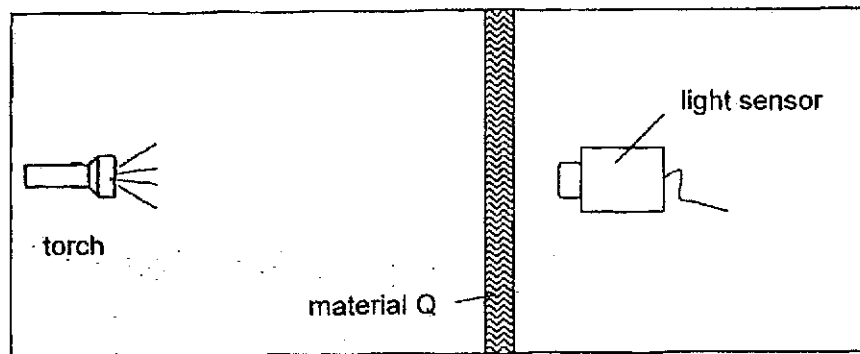

The results are shown in the table below.

Material	Amount of light detected by the light sensor (units)
Q	0
R	380

- (a) State the variable to be changed in this experiment. [1]

- (b) Which material, Q or R, is more suitable to make a toilet door that provides privacy for the user? Explain your answer. [2]

Two different shapes were cut out from materials Q and R.



Shapes A and B were glued together to form object C as shown below.



A light source was shone on object C and a shadow was formed on the screen.

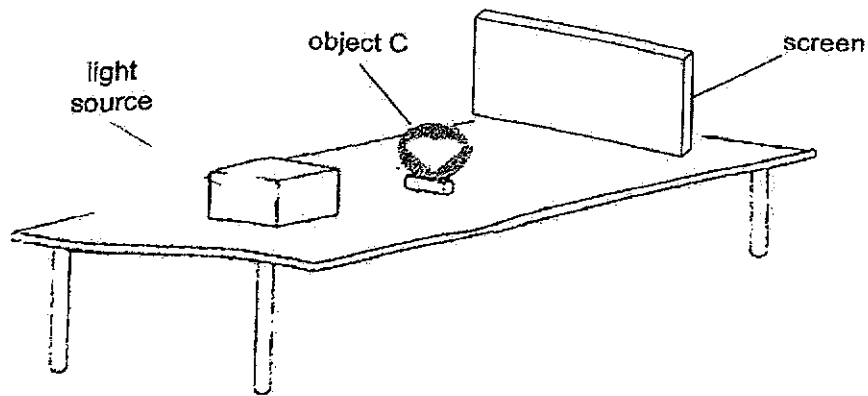

(c) Put a tick () in one of the boxes below to show the shadow of object C that will be formed on the screen.

[1]

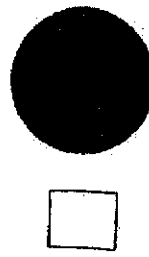

(Go on to the next page)

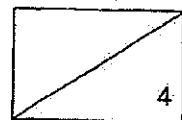

- 8 Marcus placed two wooden boxes of different heights, A and B, in front of a screen and shone a torch on them as shown in the diagram below.

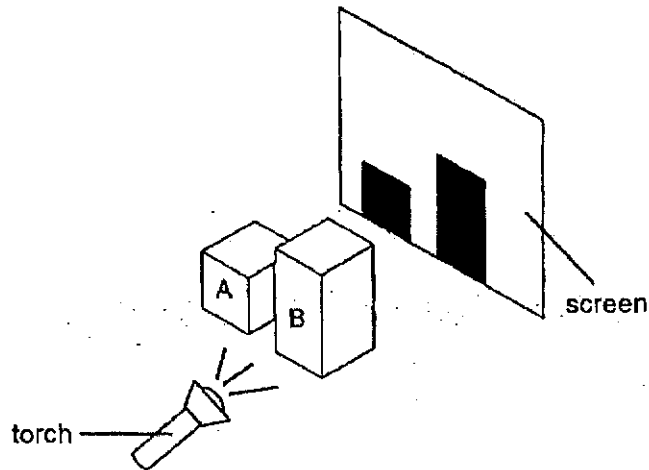

- (a) Explain how the two shadows are formed on the screen. [1]

- (b) Moving only box A, suggest how Marcus can make the height of the shadow of box A taller than the height of the shadow of box B. [1]

- (c) Marcus replaced the wooden boxes with boxes made of a different material. He noticed that a lighter shadow was formed. State a reason why a lighter shadow was observed. [1]

End of Paper

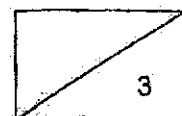



Term 3 Weighted Assessment 2024
ANSWER KEY

Section A

Qn	Answer
1	1
2	3
3	2
4	1
5	1

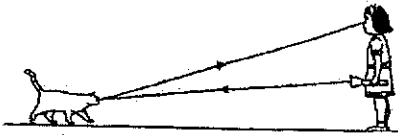
Section B:

Qn	Answer
6a	
6b	Light travels in straight lines. / Light is reflected from the object into the eye.
7a	the type of material
7b	<p>Ch : Material Q</p> <p>E : No light is detected by light sensor for material Q.</p> <p>C : Material Q is opaque. / Material Q does not allow any light to pass through.</p> <p>L : Hence, it will ensure privacy for the user of the toilet. / so others cannot see the user in the toilet.</p>
7c	
8a	The shadows are formed when the light from the torch is blocked by the boxes.
8b	Move box A closer to the torch / away from the screen.
8c	The new boxes allow some light to pass through/ blocks some light thus a lighter shadow is formed. / The new boxes are made of translucent material.

