



**Rosyth School**  
**End-of-Year Examination 2024**  
**Mathematics**  
**Primary 5**  
**Paper 1**

Name: \_\_\_\_\_ Register No. \_\_\_\_\_

Class: Pr 5 - \_\_\_\_\_

Date: 22 October 2024 Parent's Signature: \_\_\_\_\_

Total Time for Booklets A and B : 1 hour

### BOOKLET A

Instructions to Pupils:

1. Do not open this booklet until you are told to do so.
2. Follow all instructions carefully.
3. Shade your answers in the Optical Answer Sheet (OAS) provided.
4. You are not allowed to use a calculator.
5. Answer all questions.

Section	Maximum Mark	Marks Obtained
Paper 1 (Booklet A)	20	

\* This booklet consists of 8 pages (including this cover page).

Questions 1 to 10 carry 1 mark each. Questions 11 to 15 carry 2 marks each. For each question, four options are given. One of them is the correct answer. Make your choice (1, 2, 3 or 4) and write your answer in the brackets provided.

*All diagrams in this paper are not drawn to scale unless stated otherwise.*

(20 marks)

1. What is the value of  $35 - (8 + 12) \div 5 \times 3$ ?

- (1) 1
- (2) 9
- (3) 23
- (4) 93

2.  $50\ 000 + 7000 + 300 + 6 =$  \_\_\_\_\_

- (1) 57 360
- (2) 57 306
- (3) 57 036
- (4) 50 736

3. Express  $1\frac{3}{20}$  as a decimal.

- (1) 1.015
- (2) 1.15
- (3) 1.3
- (4) 1.32

(Go on to the next page)

4. In a Math test, Alison answered 4 out of 20 questions wrongly. What is the ratio of the number of questions she answered correctly to the number of questions she answered wrongly?

- (1) 1 : 5
- (2) 1 : 4
- (3) 5 : 1
- (4) 4 : 1

5. In the figure below, ST and UV are straight lines. Which of the following is true?

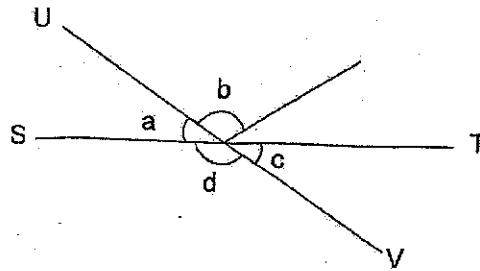

- (1)  $\angle a = \angle c$
- (2)  $\angle b = \angle d$
- (3)  $\angle a + \angle b = 180^\circ$
- (4)  $\angle b + \angle d = 180^\circ$

(Go on to the next page)

6. In the figure below, find the value of  $\angle m$ .

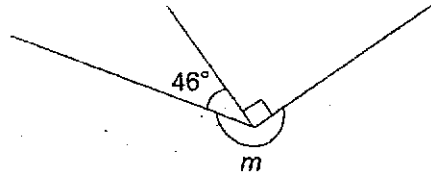

- (1)  $44^\circ$   
 (2)  $136^\circ$   
 (3)  $224^\circ$   
 (4)  $314^\circ$
7. Calculate the area of the shaded triangle.

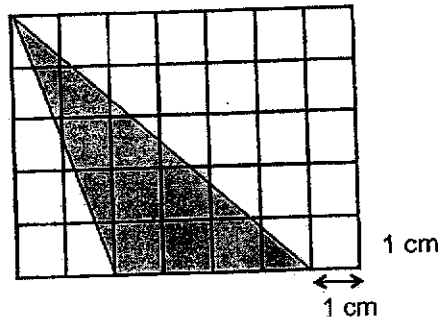

- (1)  $4 \text{ cm}^2$   
 (2)  $5 \text{ cm}^2$   
 (3)  $10 \text{ cm}^2$   
 (4)  $20 \text{ cm}^2$

(Go on to the next page)

8. What fraction of the squares is shaded?

(1)  $\frac{4}{9}$

(2)  $\frac{5}{9}$

(3)  $\frac{1}{2}$

(4)  $\frac{4}{5}$

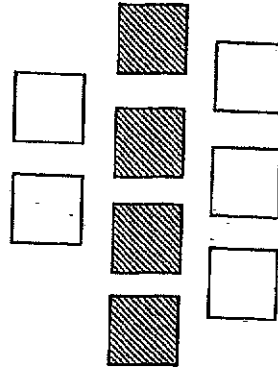

9. Sanjeev has \$200. He gave \$80 to his sister. What percentage of his money did Sanjeev give to his sister?

(1) 20%

(2) 40%

(3) 60%

(4) 80%

10. The sum of 4 numbers is 1020. One of the numbers is 150. What is the average of the other 3 numbers?

(1) 105

(2) 255

(3) 290

(4) 340

(Go on to the next page)

11. Kendra has 60 pieces of ribbons. Each piece of ribbon is 1.28 m long. What is the total length of 60 such pieces of ribbons?
- (1) 7.68 m
  - (2) 76.8 m
  - (3) 768 m
  - (4) 7680 m
12. Mr Kim prepared  $\frac{9}{10}$  ℓ of orange juice. His son drank  $\frac{2}{3}$  of it. How much orange juice was left?
- (1)  $\frac{3}{5}$  ℓ
  - (2)  $\frac{3}{10}$  ℓ
  - (3)  $\frac{7}{30}$  ℓ
  - (4)  $\frac{17}{30}$  ℓ

(Go on to the next page)

13. Which two shapes shown in the grid have the same area?

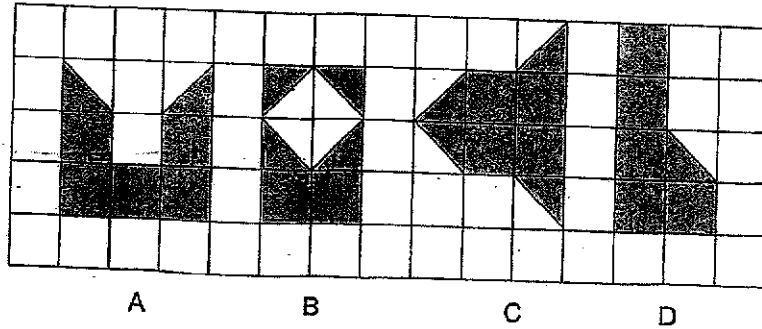

- (1) A and C  
 (2) A and D  
 (3) B and C  
 (4) B and D
14. The ratio of the number of boys to the number of girls was 3 : 5. Each boy was given 2 stickers and each girl was given 3. The girls received 81 more stickers than the boys. How many stickers did the boys receive in total?
- (1) 27  
 (2) 45  
 (3) 54  
 (4) 135

(Go on to the next page)

15. In a school library,  $\frac{1}{4}$  of the students and an additional 3 students were at the English Section. 3 fewer than  $\frac{1}{3}$  of the remaining students in the library were at the Mother Tongue Section and the rest of the 27 students in the library were at the Media Section. How many students were at the Mother Tongue Section?
- (1) 9
  - (2) 12
  - (3) 15
  - (4) 36

(Go on to Booklet B)



**Rosyth School**  
**End-of-Year Examination 2024**  
**Mathematics**  
**Primary 5**  
**Paper 1**

Name: \_\_\_\_\_ Register No. \_\_\_\_\_

Class: Pr 5 - \_\_\_\_\_

Date: 22 October 2024

Parent's Signature: \_\_\_\_\_

Total Time for Booklets A and B : 1 hour

**BOOKLET B**

Instructions to Pupils:

1. Do not turn over this page until you are told to do so.
2. Follow all instructions carefully.
3. Answer all questions.
4. Use a dark blue or black ballpoint pen to write your answers in the space provided for each question.
5. Do not use correction fluid/tape or highlighters.
6. You are not allowed to use a calculator.

Section	Maximum Mark	Marks Obtained
Paper 1 (Booklet B)	25	

\* This booklet consists of 9 pages (including this cover page).

Questions 16 to 20 carry 1 mark each. Write your answers in the spaces provided.  
For questions which require units, give your answers in the units stated.

Do not write  
in this space

**All diagrams in this paper are not drawn to scale unless stated otherwise.**  
(5 marks)

16. Find the value of  $0.35 \times 4000$

Ans: \_\_\_\_\_

17. Write down all the common factors of 16 and 56.

Ans: \_\_\_\_\_

18. Find the value of  $\frac{1}{2} \times \frac{8}{5}$

Ans: \_\_\_\_\_

19. The figure below is made up of squares. Shade two squares to form a symmetric figure with XY as the line of symmetry.

Do not write in this space

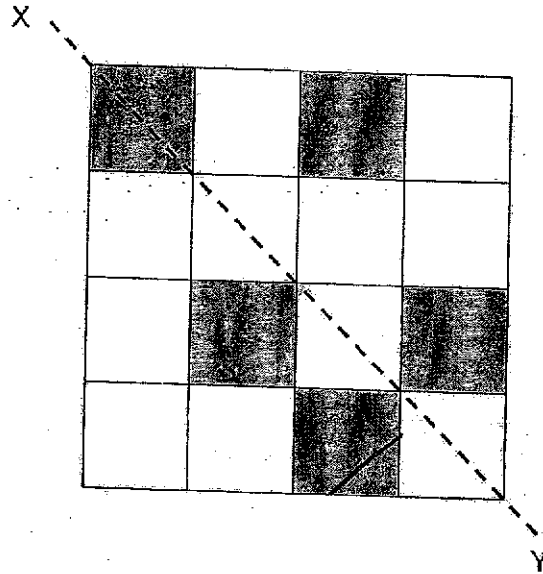

20. The figure below shows four roads drawn on a map in a square grid. Name two roads that are perpendicular to each other.

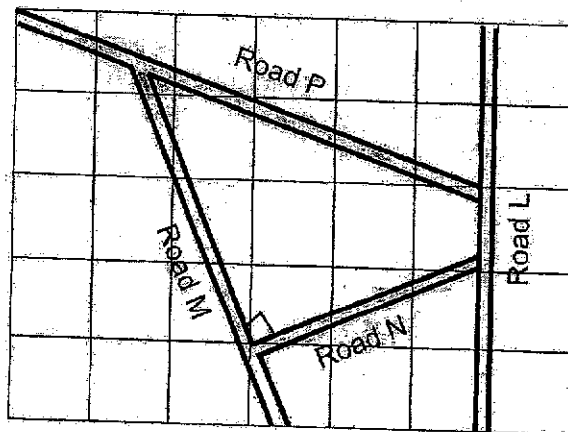

Ans: Road \_\_\_\_\_ and Road \_\_\_\_\_

Questions 21 to 30 carry 2 marks each. Show your workings clearly in the space provided for each question and write your answers in the spaces provided. For questions which require units, give your answers in the units stated. Do not write in this space

**All diagrams in this paper are not drawn to scale unless stated otherwise.**  
(20 marks)

21. At a sale, Mr Sim bought 10 mugs of the same kind. Mrs Sim bought 8 such mugs. She also bought 3 towels at \$2.50 each. Altogether, Mrs Sim spent \$2.30 less than Mr Sim. What was the total amount of money both Mr and Mrs Sim spent?

Ans: \$ \_\_\_\_\_

22. The pupils at a camp are divided equally into Camp A and Camp B.  
The ratio of the number of boys to the number of girls in Camp A is 2 : 1.  
The ratio of the number of boys to the number of girls in Camp B is 4 : 11.  
What is the ratio of the number of boys to the number of girls at the camp?  
Give your answer in the simplest form.

Ans: \_\_\_\_\_

23. The bar graph below shows the number of burgers sold at a restaurant from January to April. The number of burgers sold is not shown on the scale. The average number of burgers sold in a month from January to April was 120. How many burgers were sold in April?

Do not write in this space

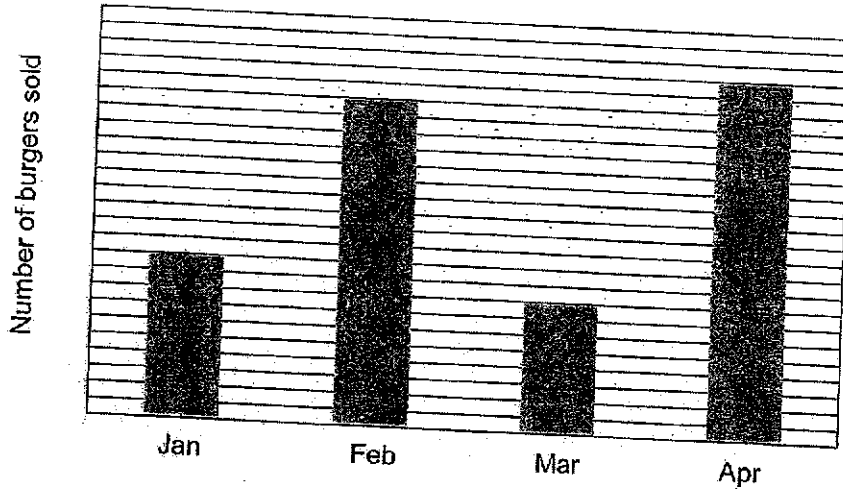

Ans : \_\_\_\_\_



24. Tim had 5 tins of marbles. At first, each of the tins contained the same number of marbles. He took 18 marbles from each tin. After that, the total number of marbles left in the 5 tins was equal to the total number of marbles in 2 of the tins at first. What was the number of marbles in each tin at first?

Do not write  
in this space

Ans: \_\_\_\_\_

25. In the figure, ABCD is a rectangle.  $\angle AEB = 65^\circ$  and  $\angle BDC = 43^\circ$ , find  $\angle EBD$ .

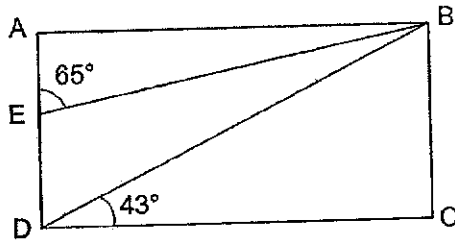

Ans: \_\_\_\_\_°

26. Malik bought a sofa set which cost \$1200 before a GST of 9%. What was the amount of GST that he had to pay for the sofa set?

Do not write  
in this space

Ans: \$

27. Draw a triangle XYZ in which  $YZ = 5$  cm,  $XY = 7$  cm and  $\angle XYZ = 55^\circ$ .  
Use a pencil to draw your diagram and label it clearly.

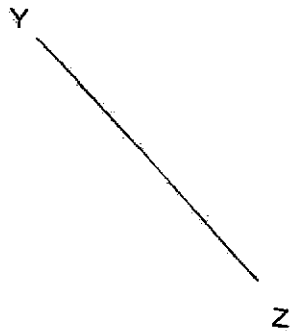

28. The figure below is made up of 6 identical cubes.

Do not write  
in this space

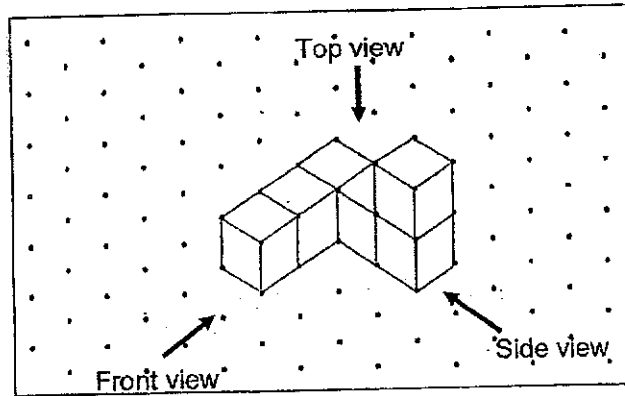

Draw the different views of the solid figure in the grid below.

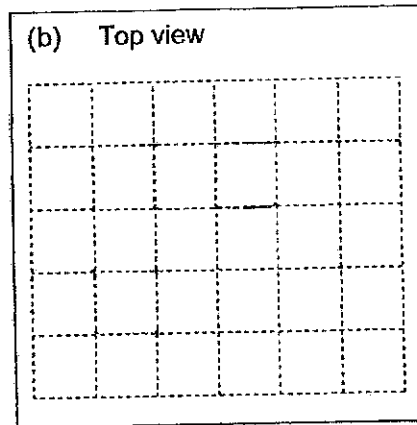
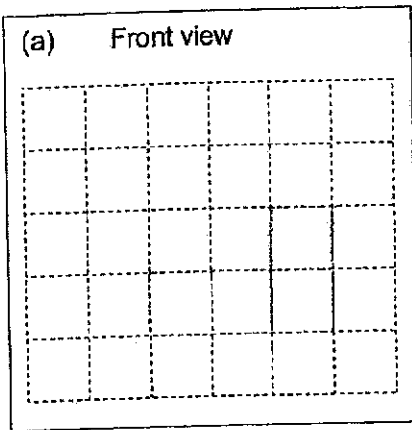

29. The figure below is a rectangle ABCD. The ratio of AE : ED = 3 : 2. The area of triangle ABE is 60 cm<sup>2</sup>. Find the area of rectangle ABCD.

Do not write in this space

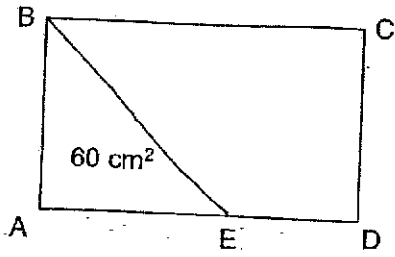

Ans: \_\_\_\_\_ cm<sup>2</sup>

30. Rosie has a rectangular piece of paper. She folded it along the dotted line as shown below. Find  $\angle a$ .

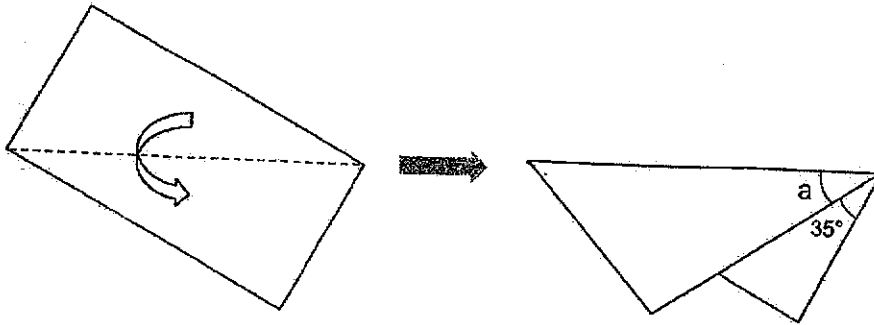

Ans: \_\_\_\_\_ °

End of Paper



**ROSYTH SCHOOL**  
**END-OF-YEAR EXAMINATION 2024**  
**MATHEMATICS**  
**PRIMARY 5**  
**PAPER 2**

Name: \_\_\_\_\_

Register No. \_\_\_\_\_

Class: Pr 5 \_\_\_\_\_

Date: 22 October 2024

Parent's Signature: \_\_\_\_\_

Time: 1 h 30 min

Instructions to Pupils:

1. Do not turn over this page until you are told to do so.
2. Follow all instructions carefully.
3. Answer all questions.
4. **Show your workings clearly** as marks are awarded for correct working.
5. Use a dark blue or black ballpoint pen to write your answers in the space provided for each question.
6. Do not use correction fluid/tape.
7. Do not use highlighters on any part of your answers.
8. Write your answers in this booklet.
9. The use of an approved calculator is allowed.

Questions	Maximum Mark	Marks Obtained
Q 1 to 5	10	
Q 6 to 17	45	

Section	Maximum Mark	Marks Obtained
Paper 1	45	
Paper 2	55	
<b>Total</b>	<b>100</b>	

\*This booklet consists of 16 pages (including this cover page).

Questions 1 to 5 carry 2 marks each. Show your working clearly in the space provided for each question and write your answers in the spaces provided. For questions which require units, give your answers in the units stated.

(10 marks)

Do not write  
in this space

1. The figure below is made up of a rectangle and a triangle. Find the area of the figure.

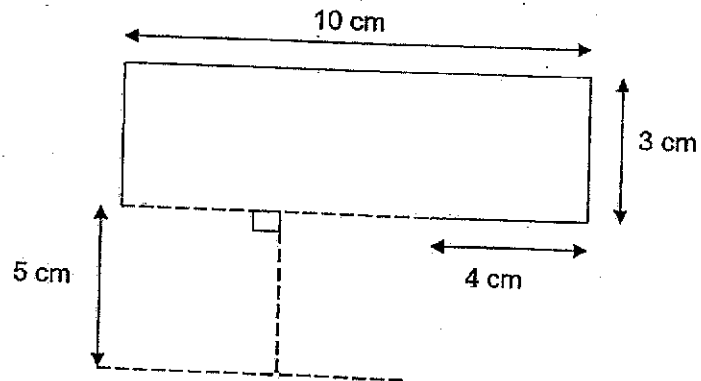

Ans: \_\_\_\_\_ cm<sup>2</sup>



2. The table below shows the rental rate for a bicycle.

Rental Rate for a Bicycle	
First hour	\$8
For every additional half hour or part thereof	\$2.50

Mr Chua rented a bicycle from 11.30 a.m. to 2.10 p.m. How much did he pay for the bike rental in total?

Ans: \$ \_\_\_\_\_

3. Mr Lee bought 2 identical tables and 2 identical chairs from a furniture store. He paid \$3450 in total. The cost of 2 chairs was \$300 more than the cost of 1 table. Find the cost of a table.

Ans: \$ \_\_\_\_\_

Do not write  
in this space



4. The average height of 33 students in the class is 127 cm. What is the total height of all the students in the class? Leave your answer in metres and centimetres.

Do not write  
in this space

Ans: \_\_\_\_\_ m \_\_\_\_\_ cm

5. ABCD is a rectangle. AC and BE are straight lines.  $\angle AEB$  is  $56^\circ$ . Find  $\angle ABE$ .

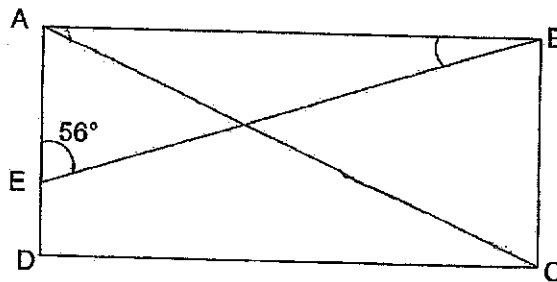

Ans: \_\_\_\_\_  $^\circ$  [2]



For questions 6 to 17, show your working clearly and write your answers in the spaces provided. The number of marks available is shown in brackets [ ] at the end of each question or part-question.

(45 marks)

Do not write  
in this space

6. At first, Amelia has an equal number of green and yellow sticks. She gave away  $\frac{1}{6}$  of her green sticks. In the end, she was left with a total of 396 sticks.

a) What fraction of her sticks left are yellow?

Ans: a) \_\_\_\_\_ [1]

b) How many green sticks did she have at first?

Ans: b) \_\_\_\_\_ [2]



7. The diagram below shows 2 isosceles triangles where  $AB = AC = AD$ .  $\angle DAB$  is  $114^\circ$ . Find  $\angle ACD$ .

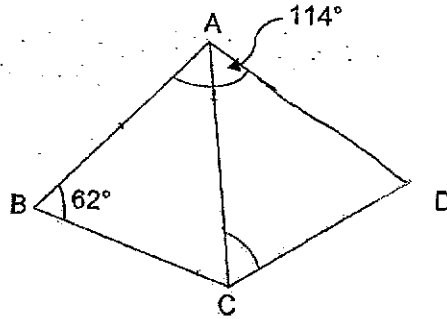

Do not write  
in this space

Ans: \_\_\_\_\_ [3]



8. Mrs Loh gave  $\frac{5}{6}$  of her money to her 3 children, Fred, Greg and Helen in the ratio of 1 : 2 : 3. Helen received \$190 more than Fred.

Do not write  
in this space

a) How much money did the 3 children receive altogether?

Ans: a) \_\_\_\_\_ [2]

b) How much money did Mrs Loh have at first?

Ans: b) \_\_\_\_\_ [2]



9. A box has a total of 3180 yellow, pink and black beads. The ratio of the number of yellow beads to the number of pink beads is 2 : 3. The ratio of the number of black beads to the total number of beads is 7 : 12.

Do not write  
in this space

- a) Write the ratio of the number of yellow beads to the number of black beads to the number of pink beads in the simplest form.

Ans: a) \_\_\_\_\_ [1]

- b) How many black beads are there in the box?

Ans: b) \_\_\_\_\_ [2]



10. The figure below shows a square ABCD with side 10 cm. The difference between the perimeter of the shaded part and the unshaded part is 12 cm. Find the area of the shaded part.

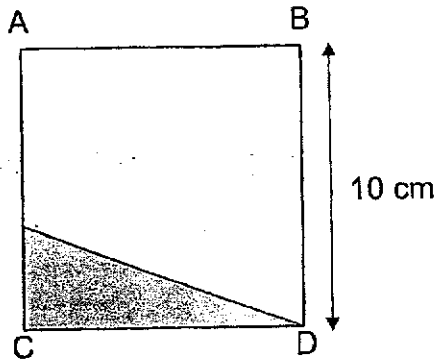

Do not write  
in this space

Ans: \_\_\_\_\_ [3]



11. ABCD is a square. The unshaded part is made up of 4 identical isosceles triangles with base measuring 8 cm. The length of CD is 6 times the length of the base of a triangle.

Do not write in this space

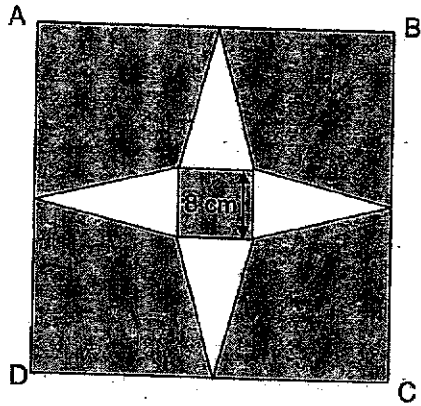

- a) Find the height of a triangle.



Ans: a) \_\_\_\_\_ [1]

- b) Find the total area of the shaded parts.

Ans: b) \_\_\_\_\_ [3]



12. Different lengths of ribbons were used to decorate big and small trees as shown below.

	
13 m of ribbon for 4 big trees	5 m of ribbons for 6 small trees

- a) Mr Yaki decorated 36 big trees and 36 small trees. How many metres of ribbon did he use altogether?

Ans: a) \_\_\_\_\_ [2]

- b) Mr Wallie used a total of 853 m of ribbon to decorate some big and small trees. He decorated 24 more small trees than big trees. How many trees did Mr Wallie decorate altogether?

Ans: b) \_\_\_\_\_ [2]



13. The line graph below shows the number of visitors who visited the National Library over a period of 5 months.

Do not write in this space

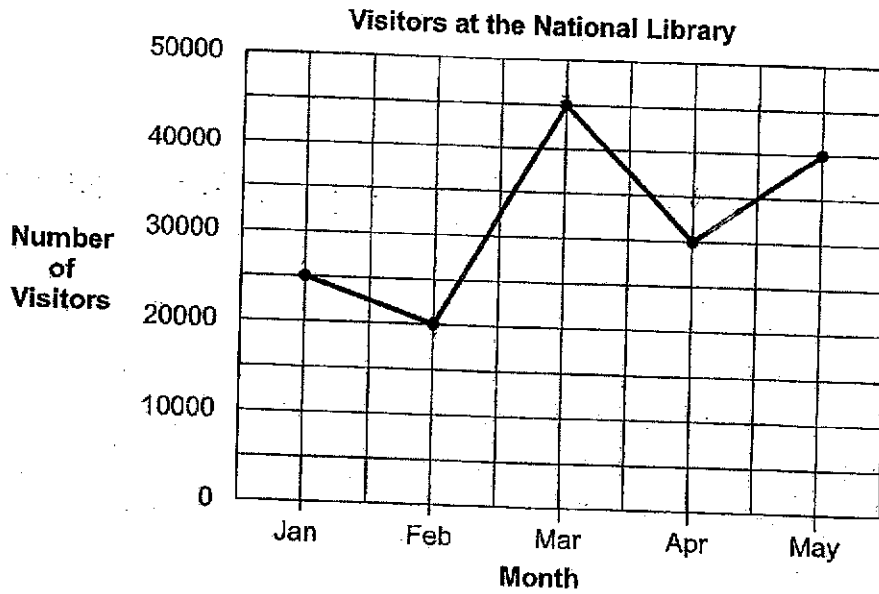

Each of the statements below is either True, False or Not possible to tell from the information given above. For each statement, put a tick (✓) to indicate your answer. [3]

Statement	True	False	Not possible to tell
a) The number of visitors for February is twice the number of May.			
b) The average number of visitors for Jan to May is 32 000.			
c) There are 20 000 visitors in June. The average number of visitors for Jan to June will increase.			



14. Peggy has a cubical tank A of edge 40 cm and a rectangular tank B measuring 40 cm by 20 cm by 35 cm. Tank A was fully filled with water while Tank B was partly filled. Peggy then poured  $\frac{1}{4}$  of the water from Tank A into Tank B. After this, the new water level in the Tank B rose to  $\frac{6}{7}$  of its height.

Do not write  
in this space

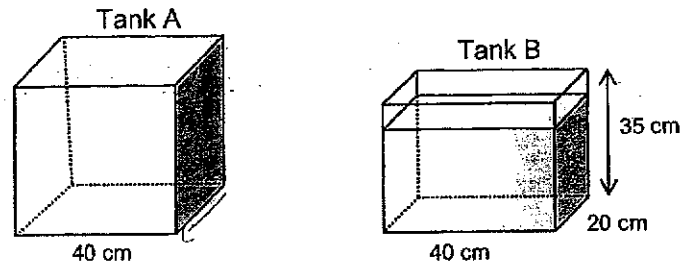

- a) Find the capacity of tank A in litres.

Ans: a) \_\_\_\_\_ [1]

- b) How much water was in the rectangular tank at first?

Ans: b) \_\_\_\_\_ [3]

15. The original price of each fan is \$35. During a sale, the discounts given to each of the fans are shown below.

Do not write in this space

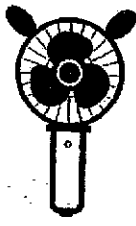

**Fan A**  
\$6.80 off  
original price

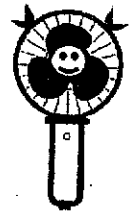

**Fan B**  
20% discount

a) Which fan was cheaper after the discount? How much is it cheaper than the other fan?

Ans: a) Fan \_\_\_\_\_ [1]

Amount: \_\_\_\_\_ [1]

b) Jefferson wanted to buy the cheaper fan on discount. He had to pay an additional 9% GST on the discounted price. How much did Jefferson have to pay for the fan in total?

Ans: b) \_\_\_\_\_ [2]

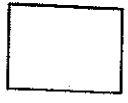

16. A box of biscuit is sold at \$5.50. For every 5 boxes of biscuits bought, 2 boxes of biscuits are given free.

Do not write  
in this space

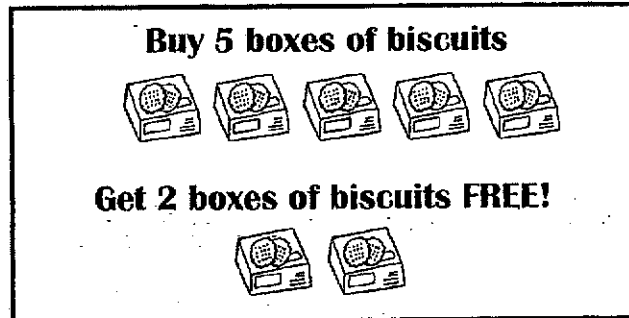

- a) Nadiah bought some boxes of biscuits and paid a total of \$126.50. How many boxes of biscuits did she have?

Ans: a) \_\_\_\_\_ [3]

- b) In every box of biscuits, there are 10 pieces of biscuits. Daryl needs to get 485 pieces of biscuits. What is the least amount of money he has to pay?

Ans: b) \_\_\_\_\_ [2]



17. Teck Huat made blueberry and chocolate muffins to sell.  $\frac{5}{6}$  of the muffins were blueberry muffins and the rest were chocolate muffins. He sold  $\frac{1}{3}$  of the total number of muffins.  $\frac{5}{6}$  of the muffins sold were blueberry muffins. There were 120 chocolate muffins left. How many blueberry muffins did he sell?

Do not write  
in this space

Ans: \_\_\_\_\_ [5]





SCHOOL : ROSYTH SCHOOL  
 LEVEL : PRIMARY 5  
 SUBJECT : MATHEMATICS  
 TERM : 2024 SA2

**BOOKLET A**

Q1	3	Q2	2	Q3	2	Q4	4	Q5	1
Q6	3	Q7	3	Q8	1	Q9	2	Q10	3
Q11	2	Q12	2	Q13	1	Q14	3	Q15	1

**BOOKLET B**

Q16	1400												
Q17	1, 2, 4, 8												
Q18	$\frac{4}{5}$												
Q19													
Q20	Road M and N												
Q21	$10M = 8M + 3T + \$2.30$ $10M = 8M + 3 \times \$2.50 + \$2.30$ $10M = 8M + \$9.80$ $2M = \$9.80$ $1M = \$9.80 \div 2 = \$4.90$ Total spent = $18 \times \$4.90 + \$7.50 = \$95.70$												
Q22	<table style="width: 100%; border-collapse: collapse;"> <thead> <tr> <th style="text-align: left; border-bottom: 1px solid black;">Camp A</th> <th style="text-align: left; border-bottom: 1px solid black;">Camp B</th> <th style="text-align: left; border-bottom: 1px solid black;">Total at camp</th> </tr> </thead> <tbody> <tr> <td>B : G : Total</td> <td>B : G : Total</td> <td>B : G</td> </tr> <tr> <td>2 : 1 : 3</td> <td>4 : 11 : 15</td> <td>10 + 4 : 11 + 5</td> </tr> <tr> <td>10 : 5 : 15</td> <td></td> <td>7 : 8</td> </tr> </tbody> </table>	Camp A	Camp B	Total at camp	B : G : Total	B : G : Total	B : G	2 : 1 : 3	4 : 11 : 15	10 + 4 : 11 + 5	10 : 5 : 15		7 : 8
Camp A	Camp B	Total at camp											
B : G : Total	B : G : Total	B : G											
2 : 1 : 3	4 : 11 : 15	10 + 4 : 11 + 5											
10 : 5 : 15		7 : 8											
Q23	176												
Q24	Units of marbles left = $5u$ Units of marbles in 2 tins at first = $2u + 36$ $5u = 2u + 36$ $3u = 36$ $1u = 12$ 1 tin at first = $12 + 18 = 30$												

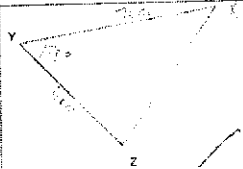
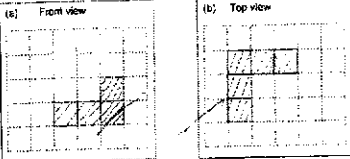
Q25	18°
Q26	\$108
Q27	
Q28	
Q29	$\frac{5}{3} \times (60 \times 2) = 200\text{cm}^2$
Q30	27.5°

**PAPER 2**

Q1	Area of triangle = $\frac{1}{2} \times 5 \times 6 = 15\text{cm}^2$ Area of rectangle = $10 \times 3 = 30\text{cm}^2$ Total area = $15 + 30 = 45\text{cm}^2$
Q2	Total duration of rental = 2h 40min Rental paid = $\$8 + 4 \times \$2.50 = \$18$
Q3	$2T + 2C = \$3450$ $1T + \$300 = 2C$ $3T + \$300 = \$3450$ $3T = \$3150$ $1T = \$1050$
Q4	Total height = $127 \times 33 = 4191\text{cm} = 41\text{m } 91\text{cm}$
Q5	$\angle ABE = 180^\circ - 90^\circ - 56^\circ = 34^\circ$
Q6a	$\frac{6}{11}$
Q6b	$11u = 396$ $1u = 36$ $6u = 6 \times 36 = 216$
Q7	$\angle CAB = 180^\circ - 62^\circ - 62^\circ = 56^\circ$ $\angle CAD = 114^\circ - 56^\circ = 58^\circ$ $\angle ACD = (180^\circ - 58^\circ) \div 2 = 61^\circ$
Q8a	$2u = \$190$ $1u = \$95$ $6u = \$95 \times 6 = \$570$

Q8b	Total at first = $\frac{6}{5} \times \$570 = \$684$
Q9a	2 : 7 : 3
Q9b	12u = 3180 1u = 265 7u = 265 x 7 = <b>1855</b>
Q10	12cm difference → extra side of square (10cm) + diff. in AC side (2cm) Height of triangle (CD as base) = (10 - 2) ÷ 2 = 4cm Area of shaded part = $\frac{1}{2} \times 10 \times 4 = 20\text{cm}^2$
Q11a	CD = 6 x 8 = 48cm Height of triangle = (48 - 8) ÷ 2 = <b>20cm</b>
Q11b	Area of 4 triangles = $4 \times \frac{1}{2} \times 8 \times 20 = 320\text{cm}^2$ Total area = 48 x 48 = 2304cm <sup>2</sup> Shaded area = 2304 - 320 = <b>1984cm<sup>2</sup></b>
Q12a	Ribbon used for big trees = (36 ÷ 4) x 13m = 117m Ribbon used for small trees = (36 ÷ 6) x 5m = 30m Total ribbon used = 117 + 30 = <b>147m</b>
Q12b	Ribbon used to decorate 24 small trees = (24 ÷ 6) x 5m = 20m LCM of 4 & 6 is 12 Group ribbon used for 12 big + 12 small as 1 set. Length of 1 set = 3 x 13m + 2 x 5m = 49m No. of sets = (853 - 20) ÷ 49 = 17 Total trees decorated = 17 x (12 + 12) + 24 = <b>432</b>
Q13	a) False b) True c) False
Q14a	40 x 40 x 40 = 64000cm <sup>3</sup> = <b>64ℓ</b>
Q14b	Water poured from A to B = $\frac{1}{4} \times 64000 = 16000\text{cm}^3$ Amount of water in B in the end = $\frac{6}{7} \times 40 \times 20 \times 35 = 24000\text{cm}^3$ Water in B at first = 24000 - 16000 = <b>8000cm<sup>3</sup></b>
Q15a	Price of A after discount = \$35 - \$6.80 = \$28.20 Price of B after discount = \$35 x 0.8 = \$28 Fan <b>B</b> , amount: <b>\$0.20</b>
Q15b	$\frac{109}{100} \times \$28 = \$30.52$

Q16a	Group 7 boxes as 1 set Cost of 1 set = $5 \times \$5.50 = \$27.50$ No. of sets = $\$126.50 \div \$27.50 = 4$ R \$16.50 $\$16.50 \div \$5.50 = 3$ Total boxes = $4 \times 7 + 3 = 31$
Q16b	No. of biscuits in 1 set = $7 \times 10 = 70$ $485 \div 70 = 6$ R 65 To get 65 more biscuits, he needs to get another set of 70 $6 + 1 = 7$ Amount to pay = $7 \times \$27.50 = 192.50$
Q17	Fraction of blueberry muffins sold = $\frac{1}{3} \times \frac{5}{6} = \frac{5}{18}$ Fraction of chocolate muffins sold = $\frac{1}{3} \times \frac{1}{6} = \frac{1}{18}$ Fraction of chocolate muffins at first = $\frac{1}{6} = \frac{3}{18}$ Fraction of chocolate muffins left = $\frac{3}{18} - \frac{1}{18} = \frac{2}{18}$ $2u = 120$ $1u = 60$ $5u = 5 \times 60 = 300$