

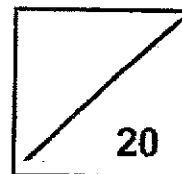

Rosyth School
Performance Task 2024
SCIENCE
Primary 5



Total
Marks:

Name: _____

Class: Pr 5 _____ Register No. _____

Duration: 50 min

Date: 30 July 2024

Instructions to pupils:

1. Do not open the booklet until you are told to do so.
2. Follow all instructions carefully.
3. There are three parts to this paper: **Part I, II and III**. Answer all questions.

* This booklet consists of 6 printed pages (including this cover page).

This paper is not to be reproduced in part or whole without the permission of the Principal.

Part I (4 marks)

The teacher will play a video and you will answer the following questions based on the video.

Aim of experiment: To find out if the amount of resistance can affect the amount of current flowing through a circuit.

(a) Watch the video and complete the **Results** table below.

Results

Amount of resistance (ohm)			[1]
Amount of current (A)			[1]

(b) Based on the results observed, state the conclusion for this experiment. [1]

(c) Explain the purpose of the set-up with no resistance in the circuit. [1]

Part II (6 marks)

Read and follow the procedure using the materials provided.

Procedure:

Set up Circuit 1 as shown below.

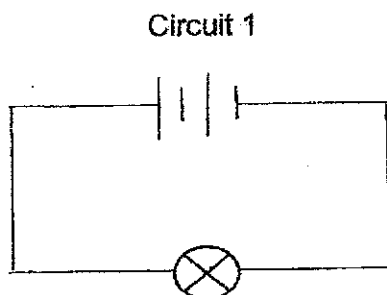

(a) State the observation. [1]

(b) Explain the observation given in (a). [2]

Set up Circuit 2 as shown below. The symbol represents a resistor.

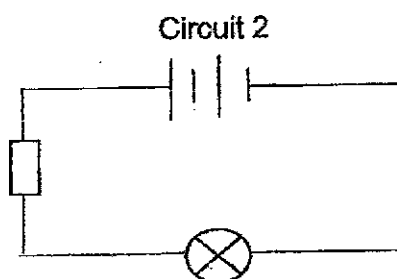

(c) Does the bulb light up? _____ [1]

(d) What has happened to the current in Circuit 2? Fill in the blanks with suitable words to complete the explanation. [2]

The current in the circuit c _____ f _____ because the resistor has h _____ resistance.

Part III (10 marks)

For questions 1 to 2, four options are given. One of them is the correct answer. Write your choice in the given brackets. Each question carries 2 marks.

1. The function of batteries in an electrical circuit is to _____.

- (1) prevent a short circuit
- (2) prevent a bulb from fusing
- (3) allow electric current flow through an electrical circuit
- (4) contain chemicals that react to produce an electric current

()

2. Study the circuit diagram below.

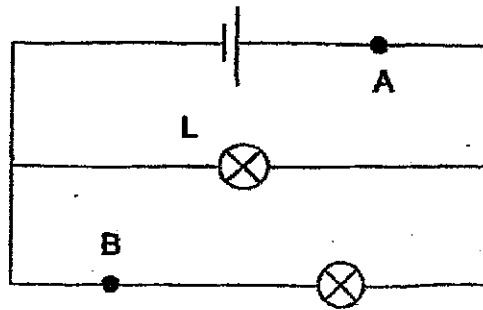

Which components can be placed at A and B of the circuit without changing the brightness of bulb L?

	A	B
(1)		
(2)		
(3)		
(4)		

()

For question 3, write your answers in the blanks provided.

3. The diagram below shows a circuit. All bulbs and batteries used in the circuit are in working condition.

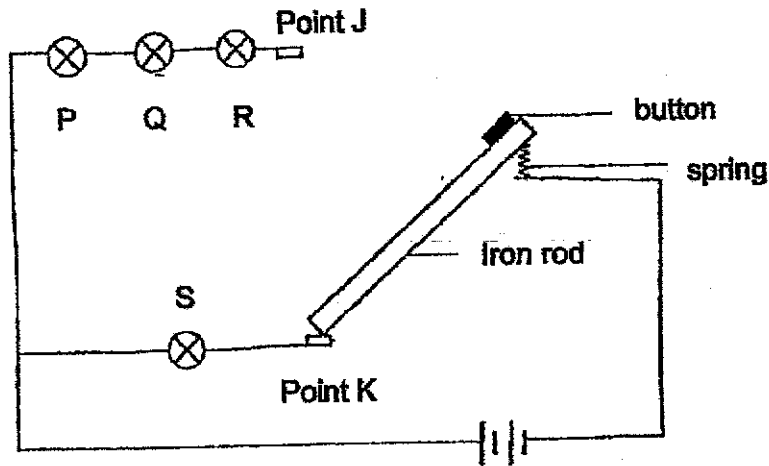

Circuit A

- (a) In circuit A, bulb S lights up because the circuit is _____, while bulbs P, Q and R do not light up because the circuit is _____. [1]

Once the button is pressed, the rod moves up and comes into contact with point J and bulbs P, Q and R will light up as shown in Circuit B.

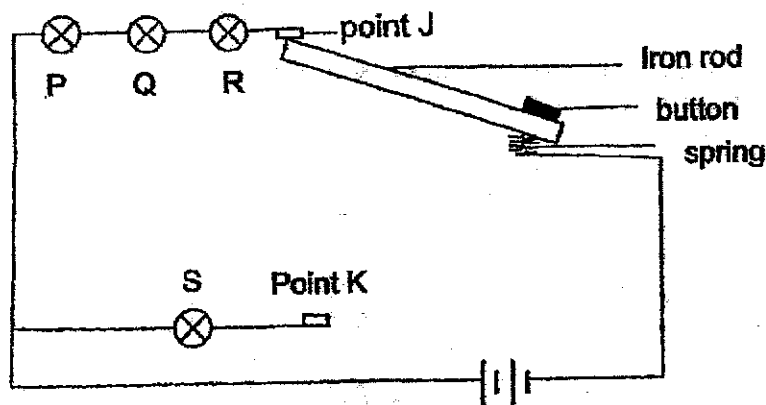

Circuit B

- (b) Bulb S in Circuit A lit up brighter compared to bulbs P, Q and R in Circuit B. Explain why. [2]

- (c) Complete the circuit by drawing bulbs P, Q and R, so that the bulbs will light up with the same brightness as bulb S in Circuit A. [3]

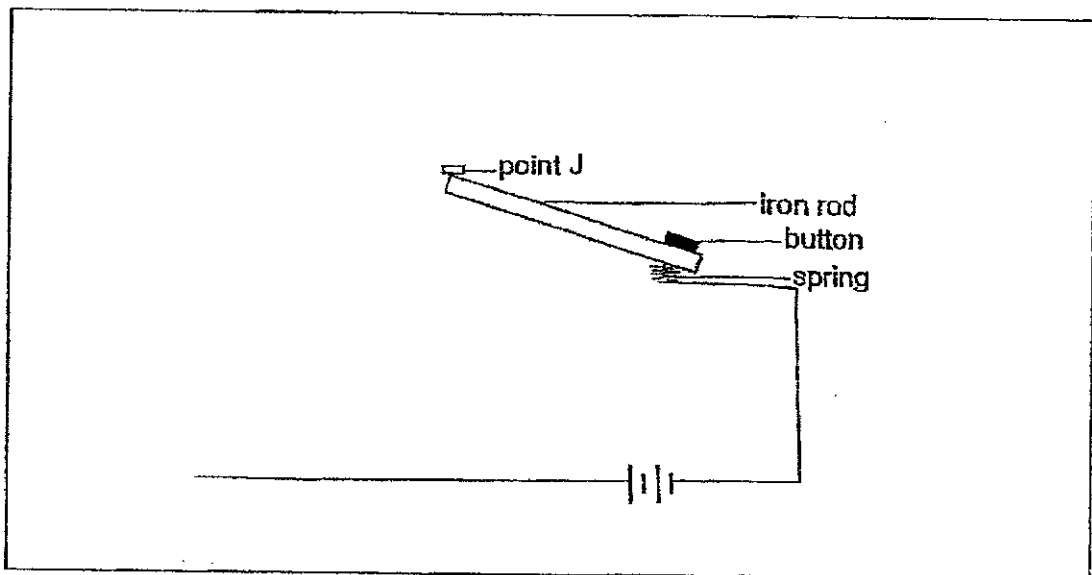

ANSWER KEY

YEAR : 2024
LEVEL : PRIMARY 5
SCHOOL : ROSYTH
SUBJECT : SCIENCE
TERM : WA 3

PART 1

a)	Amount of resistance (ohm)	0	60	120
	Amount of current (A)	1.80	0.26	0.14
b)	The higher the amount of resistance, the lower the amount of current flowing through a circuit.			
c)	To compare and confirm that the amount of resistance is the only variable affecting the amount of current flowing through the circuit.			

PART 2

a)	The bulb lights up
b)	A closed circuit is formed electricity is able to flow through the circuit and light up the bulb.
c)	no
d)	The current in the circuit cannot flow because the resistor has higher resistance.

PART 3

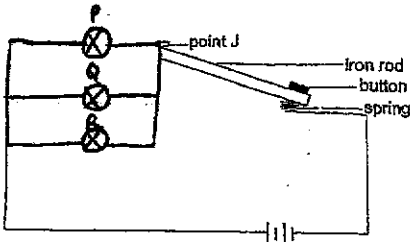
1.	4
2.	4
3.	<p>a) in circuit A, bulb S lights up because the circuit is closed, while bulbs P, Q and R do not light up because the circuit is open.</p> <p>b) P, Q, R are arranged in series, circuit B has more bulbs than circuit A, therefore bulbs is brighter.</p> <p>c)</p> 

1
END

