

Name: _____ ()

Class: Primary 5 SY / C / G / SE / P

23 October 2024



SINGAPORE CHINESE GIRLS' SCHOOL
END-OF-YEAR EXAMINATION 2024

PRIMARY 5

SCIENCE

BOOKLET A

Total Time for Booklets A and B: 1h 45 min

INSTRUCTIONS TO CANDIDATES

1. Write your Index No. in the boxes at the top right-hand corner.
2. Do not turn over this page until you are told to do so.
3. Follow all instructions carefully.
4. Answer all questions.
5. Use a 2B pencil to shade your answers on the Optical Answer Sheet (OAS).

This booklet consists of **23** printed pages.

For each question from 1 to 28, four options are given. One of them is the correct answer. Make your choice (1, 2, 3 or 4). Shade your answer on the Optical Answer Sheet.

[56 marks]

1 During which of the following processes are the characteristics from parents passed on to their young?

- (1) Pollination
- (2) Fertilisation
- (3) Germination
- (4) Seed dispersal

2 The diagram below shows part of the human digestive system.

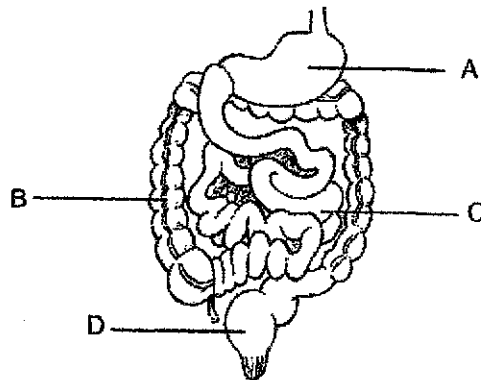

In which part, A, B, C or D, is digestion fully completed and the digested food absorbed by the body?

- (1) A
- (2) B
- (3) C
- (4) D

3 Which of the following statements is/are true of a cockroach and a mosquito?

- A Their young do not have wings.
- B Their young look like the adults.
- C They have four stages in their life cycles.

- (1) A only
- (2) B only
- (3) B and C only
- (4) A and C only

4 The diagrams below show the cross sections of the reproductive system of a flower and the female human reproductive system:

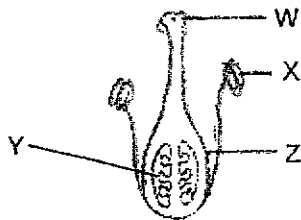

Reproductive System of a Flower

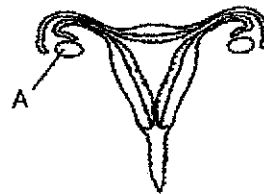

Female Human Reproductive System

Which part of the flower performs a similar function as organ A in the human reproductive system?

- (1) W
- (2) X
- (3) Y
- (4) Z

- 5 The plant below is placed in the Sun for a few hours.

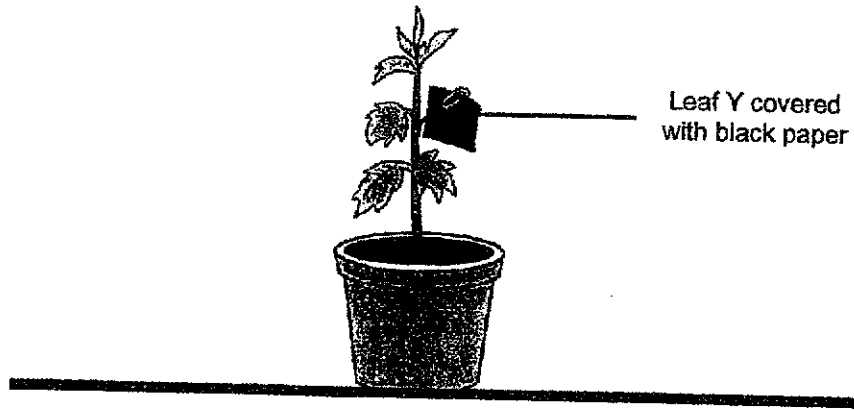

The diagram below shows a plant cell taken from leaf Y.

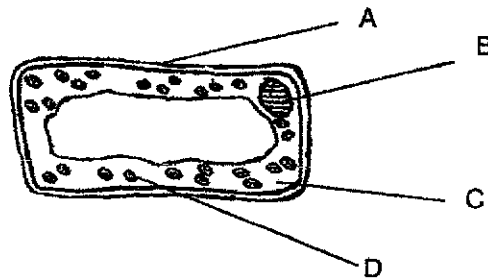

After a few hours, which part labelled A, B, C or D of the cell would not be able to function if the leaf had been covered for a few hours as shown above?

- (1) Part A
- (2) Part B
- (3) Part C
- (4) Part D

6 Study the flow chart below.

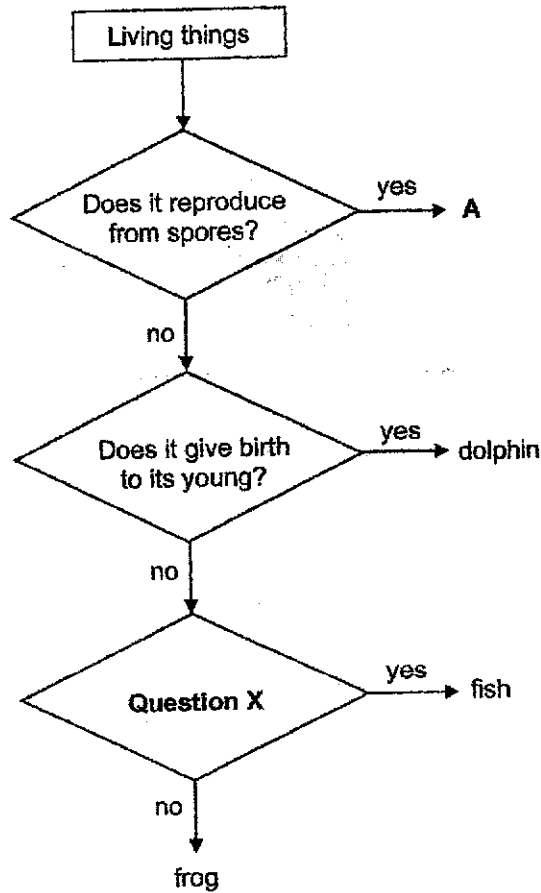

What could A and question X be?

	A	Question X
(1)	mushroom	Does it have scales?
(2)	apple tree	Does it have moist skin?
(3)	sunflower plant	Does it have scales?
(4)	fern	Does it have moist skin?

- 7 En Yi conducted an experiment using four flowers, V, W, X and Y, of the same species growing in a field. At the start of the experiment, different parts of the flowers were removed as shown below.

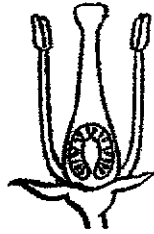

Flower V

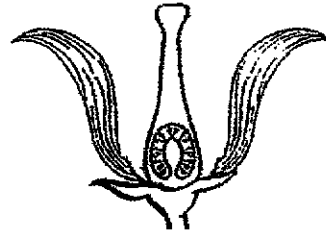

Flower W

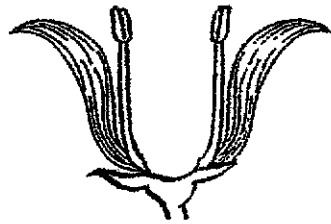

Flower X

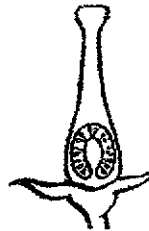

Flower Y

Which of the flowers above can still develop into a fruit?

- (1) Y only
- (2) X and Y only
- (3) W and X only
- (4) V, W and Y only

- 8 Three types of plants, X, Y and Z, were observed to be growing on a part of an island as shown in diagram A. Two years later, more plants were observed on the island as shown in diagram B.

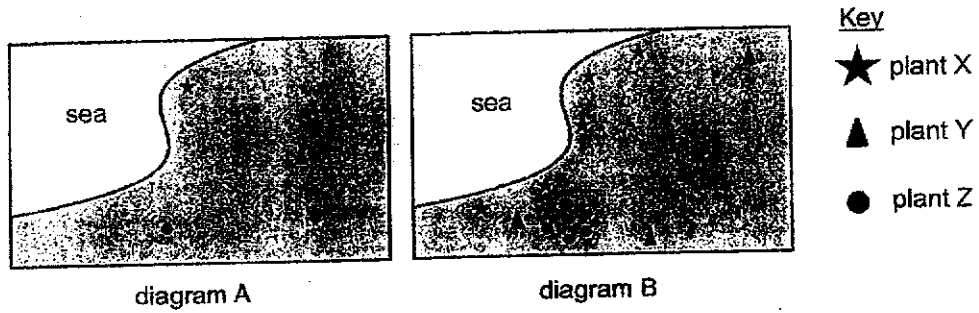

What are the likely characteristics of the fruits of plants X, Y and Z?

	X	Y	Z
(1)	waterproof covering	stiff hairs	dry, hard pod
(2)	dry, hard pod	juicy flesh	waterproof covering
(3)	stiff hairs	fibrous husk	juicy flesh
(4)	fibrous husk	dry, hard pod	stiff hairs

- 9 The diagram below represents the reproduction in a flowering plant.

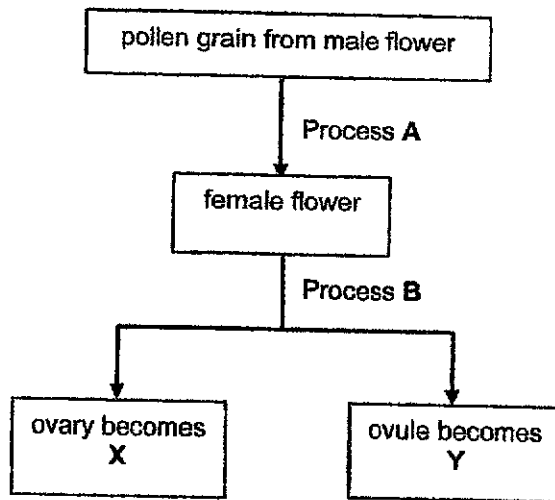

Which of the following correctly identifies process A, process B, part X and part Y?

	Process A	Process B	Part X	Part Y
(1)	pollination	germination	fruit	seed
(2)	fertilisation	pollination	seed	fruit
(3)	pollination	fertilisation	fruit	seed
(4)	germination	pollination	seed	fruit

- 10 Jamie placed a plant with two white flowers X and Y into a beaker of red-coloured water as shown below.

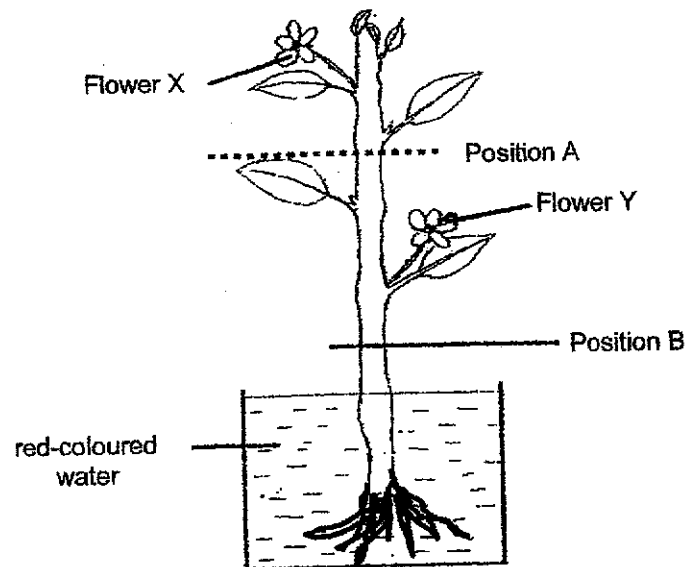

At position A, she removed both the water-carrying and food carrying tubes, but at position B, she removed only the food carrying tubes. Jamie left the set-up for a few hours before returning to jot down her observations about the flowers.

Which one of the following shows the most likely results of the experiment?

	Flower X	Flower Y
(1)	Remained white	Turned red
(2)	Turned red	Remained white
(3)	Remained white	Remained white
(4)	Turned red	Turned red

11 The diagram below shows the direction of blood flow in some parts of the body.

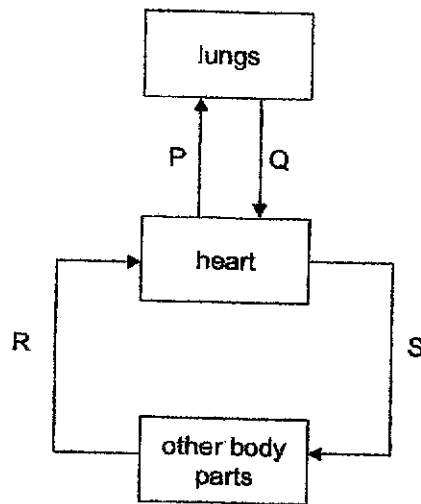

The same amount of blood samples was taken from P, Q, R and S. Which of the following shows the correct comparison of the amount of oxygen in the blood samples?

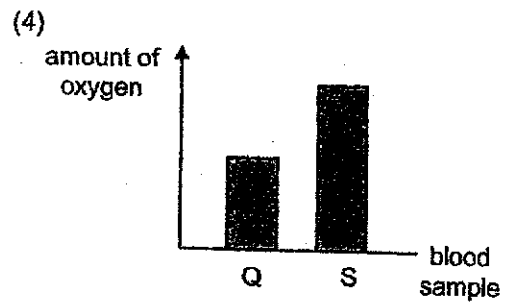
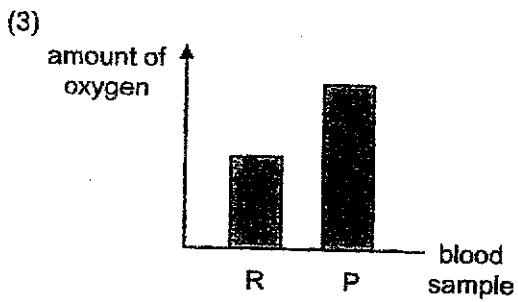
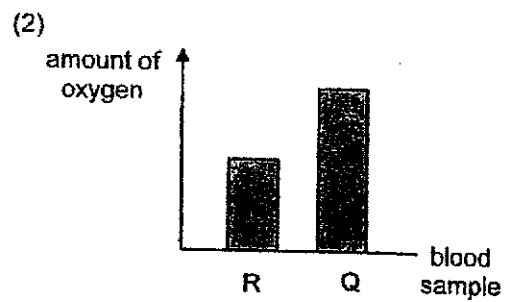
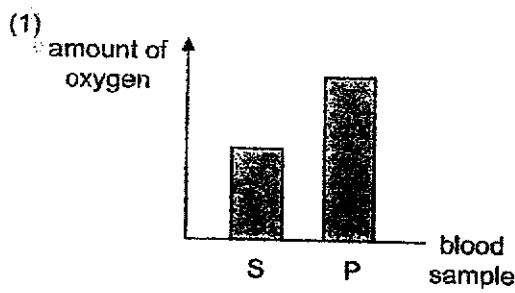

- 12 The graph shows the relationship between the mass of the shoot and the mass of seed leaves.

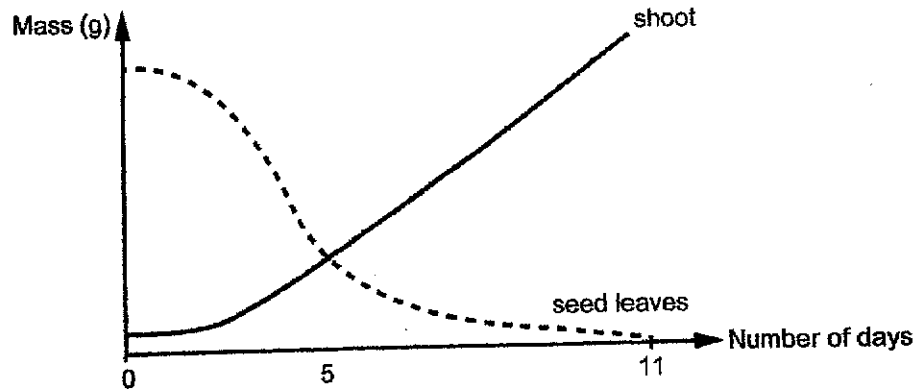

Based on the graph, which of these statements are true?

- A After Day 11, the seedling grows new seed leaves to provide food for itself.
 - B As the mass of the seed leaves decreases, the mass of the shoot increases.
 - C The mass of the seed leaves and the shoot are the same on Day 5.
 - D The seedling stops obtaining food from the seed leaves after Day 11.
- (1) A and B only
 (2) A and C only
 (3) B and D only
 (4) B, C and D only

- 13 Leela conducted an experiment to find out if the size of leaves affect the amount of oxygen given out during photosynthesis. She had three different set-ups and measured the number of oxygen bubbles given out by the plants in each set-up for one minute.

She recorded her results in the table.

Set-up	Type of water plants	Size of leaves	Number of leaves	Number of oxygen bubbles given out by the plants per minute
1	P	Small	35	10
2	Q	Medium	25	15
3	R	Large	10	10

Which of the following explains why her experiment is not fair?

- A The size of leaves used is different.
 - B The number of leaves used is different.
 - C The type of water plants used is different.
 - D The amount of oxygen collected is different.
- (1) A and C only
(2) C and D only
(3) B and C only
(4) A, C and D only

14 Wei Ming conducted an experiment as shown below.

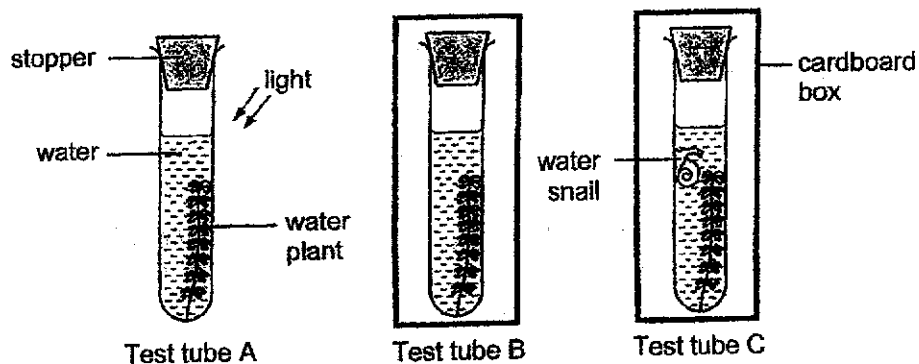

He added a drop of liquid X into each test tube. Liquid X changes colour according to the amount of carbon dioxide in the water as shown in the table below.

Amount of carbon dioxide in the water	lower than surrounding air	same as surrounding air	higher than surrounding air
Colour of liquid X	purple	red	yellow

Which of the following represents the colour change of liquid X in each test tube after two hours?

	Test tube A	Test tube B	Test tube C
(1)	purple	yellow	yellow
(2)	red	red	yellow
(3)	purple	red	red
(4)	purple	red	yellow

- 15 The diagram below shows plant with male flowers and female flowers growing on different parts of the plant.

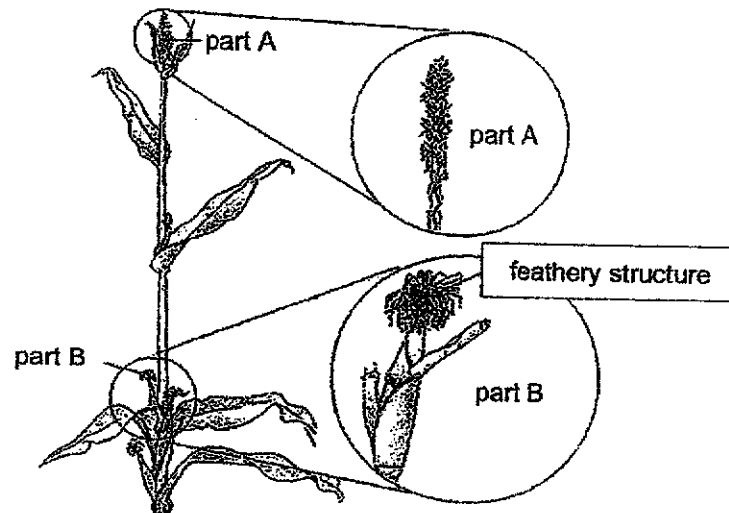

Which one of the following is correct?

	Method of pollination	Male part	Female part
(1)	animal	A	B
(2)	wind	A	B
(3)	animal	B	A
(4)	wind	B	A

- 16 Four pupils boiled a kettle of water at a school camp and observed that a substance X was produced. They then made a comparison between substance X and clouds.

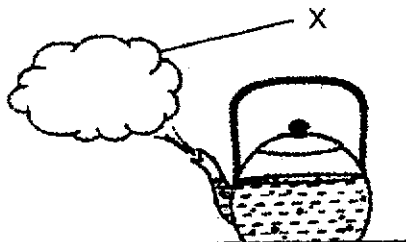

The pupils made the following statements about substances X and clouds.

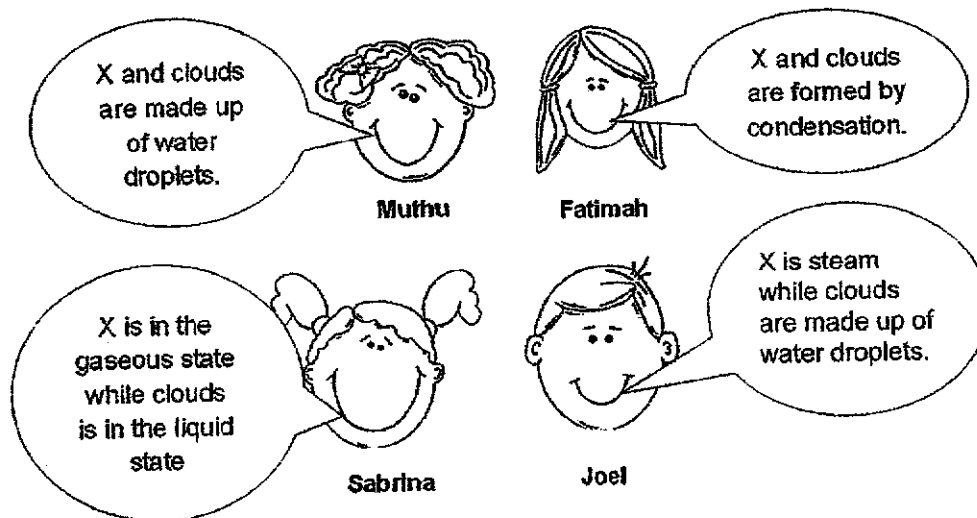

Which pupil(s) made the correct statement?

- (1) Joel only
- (2) Muthu and Fatimah only
- (3) Muthu and Sabrina only
- (4) Joel, Muthu and Sabrina only

- 17 The diagram below shows the changes in state of water in the water cycle.

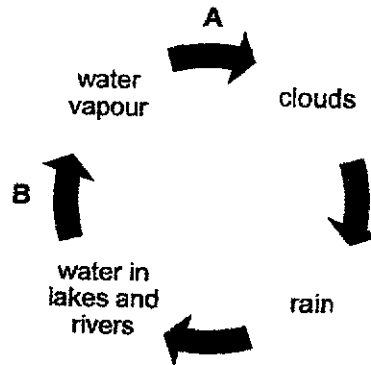

Which of the following shows the correct transfer of heat and the changes in state of water?

	Stage	Transfer of heat to water	Change of state of water
(1)	A	heat is gained	gas to liquid
(2)	A	heat is lost	liquid to gas
(3)	B	heat is lost	gas to liquid
(4)	B	heat is gained	liquid to gas

- 18 Muthu set up four experiments, W, X, Y and Z, using water in containers made of the same material. The different conditions at the start of each experiment are shown below.

	Experiment			
	W	X	Y	Z
Surrounding temperature ($^{\circ}\text{C}$)	30	25	25	25
Exposed surface area of water (cm^2)	50	120	50	50
Volume of water (cm^3)	300	300	200	300

Muthu wanted to examine how the rate of evaporation of water is affected by the exposed surface area. Which pair of experiments should Muthu compare?

- (1) W and X
- (2) W and Z
- (3) X and Y
- (4) X and Z

- 19 Haziq placed an ice cube on a plate in the kitchen at room temperature. The diagram below shows what happened to the ice cube over a period of 30 minutes.

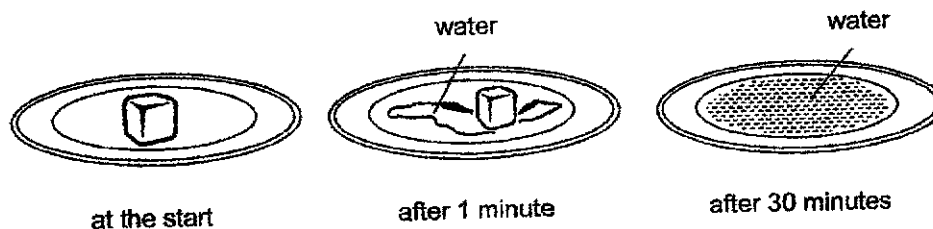

What is the likely temperature of the water found on the plate after 1 minute and after 30 minutes?

Temperature of water (°C)		
	After 1 minute	After 30 minutes
(1)	0	0
(2)	0	25
(3)	5	15
(4)	5	25

- 20 The table below shows the state of four substances W, X, Y and Z at different temperatures.

Substance	30°C	60°C	80°C
W	solid	liquid	liquid
X	solid	solid	liquid
Y	solid	solid	solid
Z	liquid	liquid	liquid

Which one of the following statements is correct?

- (1) The boiling point of substance X is 80°C.
- (2) Substance Z has the highest melting point.
- (3) Substance Y has the highest freezing point.
- (4) The freezing point of substance W is most likely 30°C.

- 21 Three identical glasses containing water at different temperatures were placed in a room. The room temperature was 26 °C.

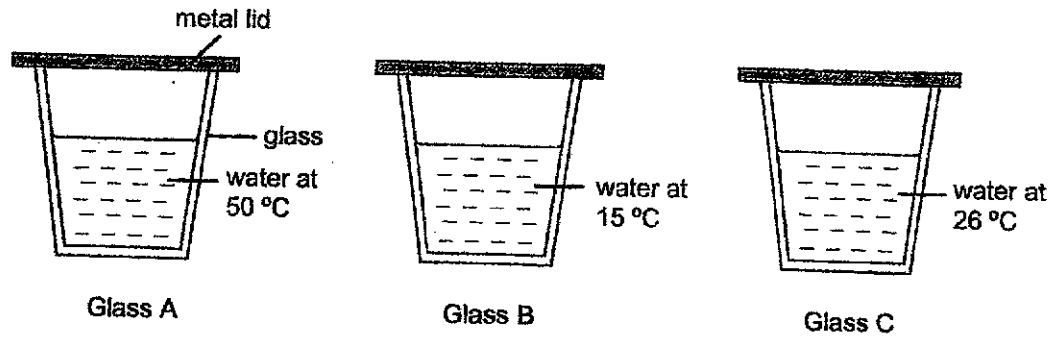

Which of the following is most likely to be observed after five minutes?

	Glass A	Glass B	Glass C
(1)			
(2)			
(3)			
(4)			

- 22 Siva carried out an experiment using a table lamp and an iron ball as shown below. The iron ball could be moved closer or further from the table lamp.

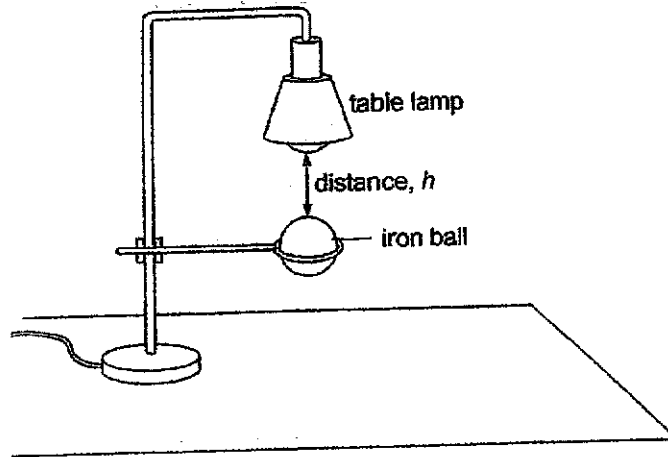

The table below shows four sets of results, A, B, C and D.

Distance, h (cm)	Size of shadow (cm)			
	A	B	C	D
6	3	5	3	4
8	4	4	5	3
10	5	3	4	5

Which set of results is correct?

- (1) A
- (2) B
- (3) C
- (4) D

23 A company wanted to select materials to make a cooler box and the base of a frying pan.

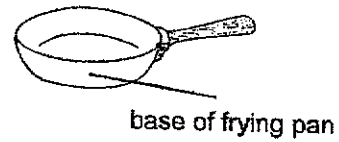

The company's engineer used four different materials, W, X, Y and Z to wrap around four similar glass beakers containing water at 100 °C each. The set-ups were left to cool in a room.

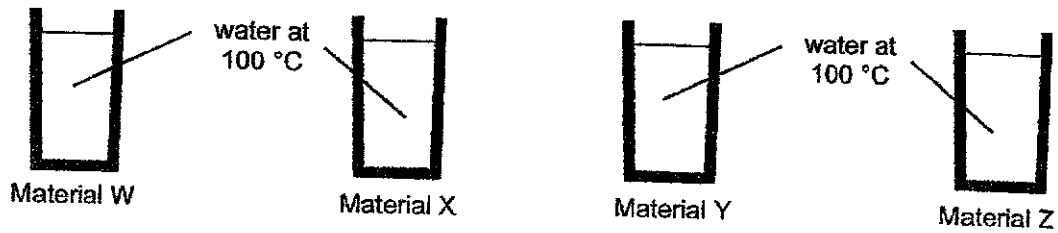

The graph below shows the change in temperature of the various materials over two hours.

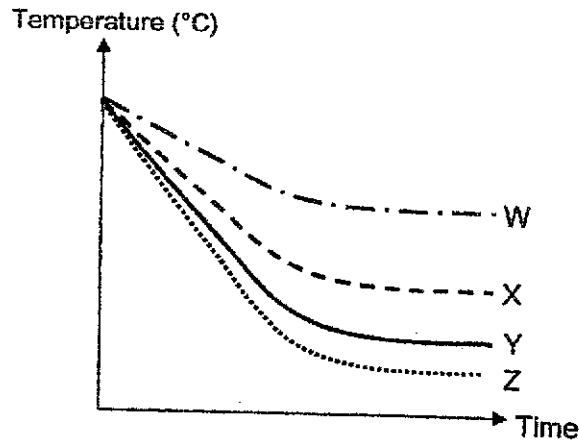

Which of the following shows the best material to make a cooler box and the base of a frying pan?

	Cooler Box	Frying pan
(1)	X	Y
(2)	W	Z
(3)	Y	X
(4)	Z	W

- 24 Danish had a bar magnet. He placed a block at each point, P, Q and R, and continued adding more blocks to each point until no more blocks could be attached without dropping. The results are as shown.

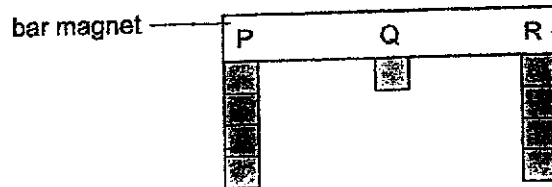

Which of the following can be concluded from the results?

- A The blocks are made of a magnetic material.
 - B Point P is the North pole and point R is the South pole.
 - C The magnetic attraction at point P is stronger than at point Q.
- (1) C only
 (2) A and B only
 (3) A and C only
 (4) A, B and C
- 25 Jim had a sealed metal container with a volume of 600 cm^3 . There was 500 cm^3 of water in the container.

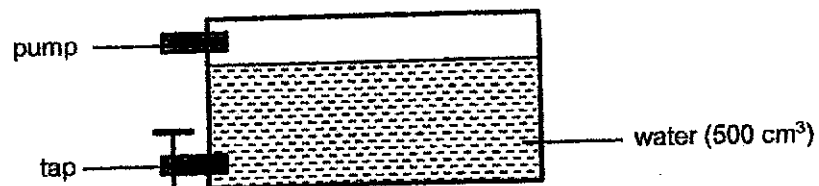

He used the tap to remove 100 cm^3 of water. He then used the pump to add 200 cm^3 of air into the tank.

Which of the following shows the final volume of air and water in the container?

	Final volume of air (cm^3)	Final volume of water (cm^3)
(1)	200	400
(2)	400	400
(3)	100	500
(4)	300	500

26 The diagrams below show four circuits.

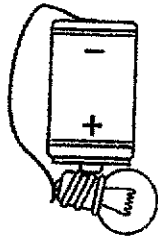

Circuit A



Circuit B

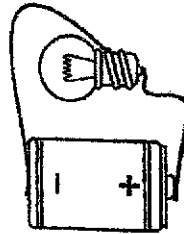

Circuit C

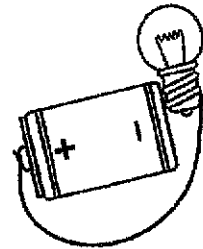

Circuit D

In which of the circuits will the bulb light up?

- (1) B only
- (2) A and B only
- (3) A and C only
- (4) A, B, C, and D

27 Chong Ming set up the following circuit.

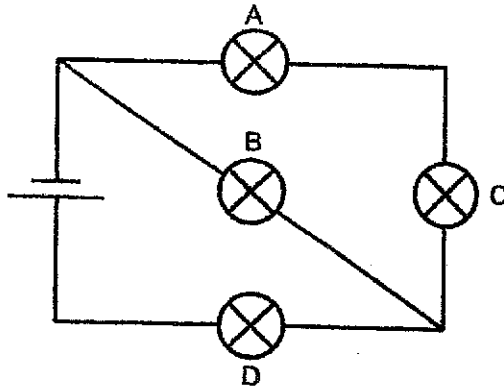

When one of the bulbs had fused, all the other bulbs did not light up. Which bulb had fused?

- (1) A
- (2) B
- (3) C
- (4) D

28 Caili set up a circuit. She recorded her results in the table below.

Switch A	Switch B	Number of bulbs which lit up
CLOSE	OPEN	1
OPEN	CLOSE	1

Which circuit did she set up?

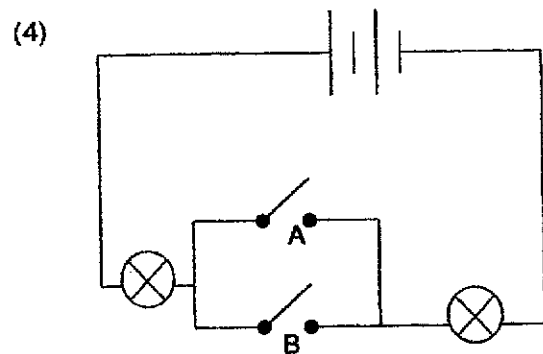
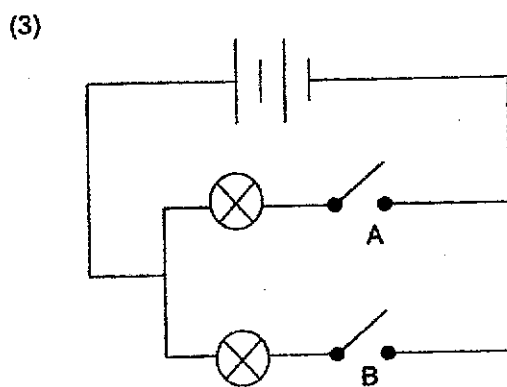
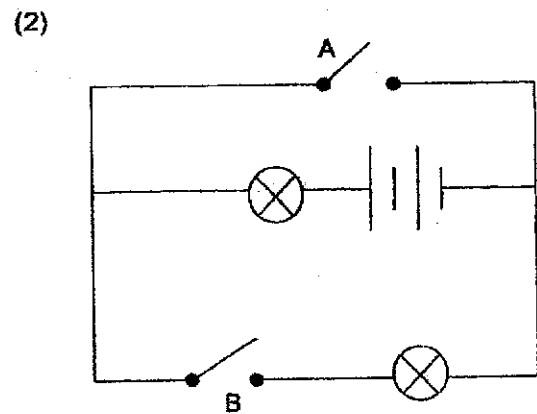
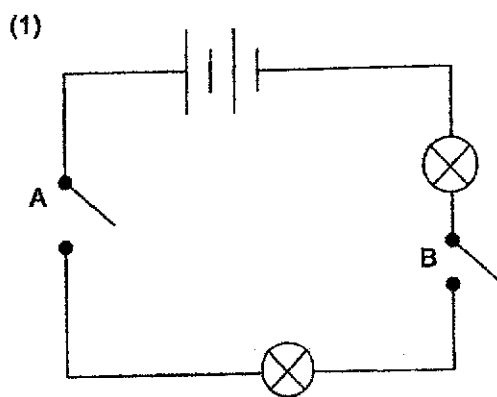

END OF BOOKLET A

Name: _____ ()

Class: Primary 5 SY / C / G / SE / P

23 October 2024



SINGAPORE CHINESE GIRLS' SCHOOL
PRELIMINARY EXAMINATION 2024

PRIMARY 5
SCIENCE

BOOKLET B

Total Time for Booklets A and B: 1h 45 min

INSTRUCTIONS TO CANDIDATES

1. Write your Index No. in the boxes at the top right-hand corner.
2. Do not turn over this page until you are told to do so.
3. Follow all instructions carefully.
4. Answer all questions.

This booklet consists of 18 printed pages.

**BLANK
PAGE**

For questions 29 to 40, write your answers in this booklet.
 The number of marks available is shown in brackets [] at the end of each question or part question.

[44 marks]

29 The diagram below shows cell A. It is a microorganism which lives in sewage water.

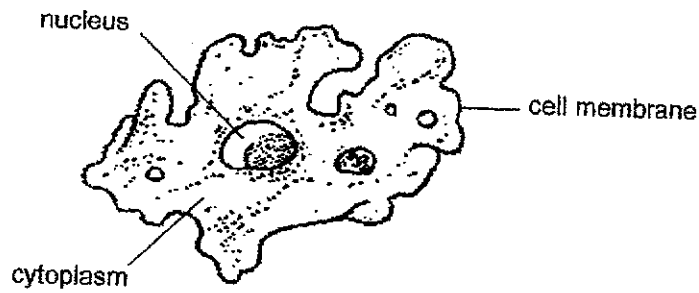

(a) Based on the diagram above, state why cell A is more likely to be an animal cell than a plant cell. [1]

(b) State the function of the cell membrane. [1]

(c) Cell A can affect an organ in the human digestive system, leading to diarrhoea or watery waste.

Which organ in the human digestive system is most likely affected by cell A?
 Explain your answer.

[1]

SCORE	3
-------	---

30 The diagram below shows how blood flows in a fish. Arrows P, Q and R represent the direction of the flow of blood.

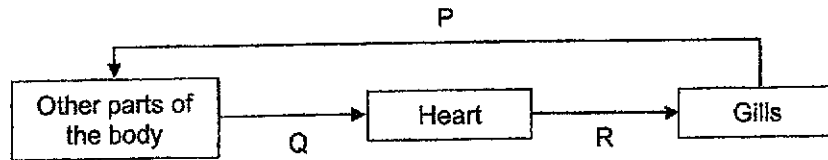

(a) Which arrow(s), P, Q or R, represent(s) the flow of oxygen-rich blood? Explain your answer. [2]

(b) The diagrams below show an air sac in the lungs of a healthy person and in a person suffering from respiratory disease P.

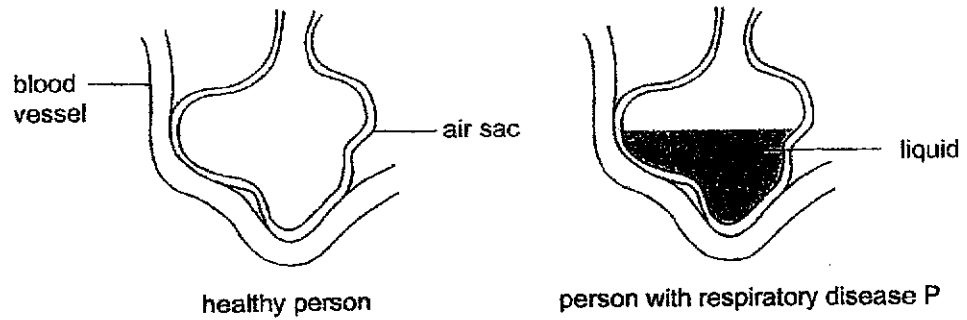

Based on the information above, explain why a person suffering from respiratory disease P has a higher breathing rate than a healthy person. [2]

SCORE	4
-------	---

- 31 Shin Huat removed the outer ring of the stem of a plant as shown. Only the food-carrying tubes were removed at part X.

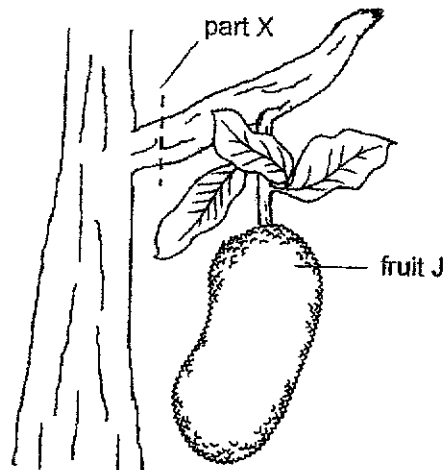

- (a) He observed that the fruit grew bigger after some time. Explain why. [2]

Ripe fruit J gives out gas X.

Shin Huat wanted to investigate if gas X will help unripe fruit J to ripen more quickly.

He has **only** the items below. He may use some or all of them.

Item	Quantity
ripe fruit J	2
unripe fruit J	2

- (b) Shin Huat used two identical clear containers for his investigation. What item(s) should he put inside the container for each set-up? [2]

Experimental set-up: _____

Control set-up : _____

SCORE	4
-------	---

- 32 Sam carried out an experiment to find out how the height from which seed M is dropped affects the distance it travels.



He dropped seed M from a height in front of a fan and measured the distance travelled by the seed, as shown in the diagram below. He repeated the experiment by dropping seed M from different heights.

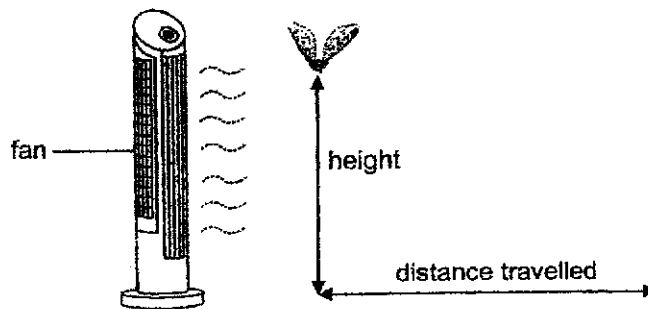

The table below shows his results.

Height (cm)	Distance travelled (cm)		
	1 st try	2 nd try	3 rd try
120	46	41	39
100	38	40	43
80	26	23	22

- (a) What is the relationship between the height from which the seed is dropped and the distance it travelled? [1]

- (b) Why did Sam take more than one reading for each height when dropping the seed? [1]

(Question 32 continues next page)

- (c) Sam then wanted to find out how the wing length of the seed affects the distance it travels. He modified the procedure from his first experiment to investigate his new aim. The table below shows his new experimental procedure.

Fill in the blanks for the procedure for steps 2 and 4.

[2]

Step	Procedure
1	Switch on the fan.
2	<hr/> <hr/>
3	Measure the distance travelled by the seed.
4	<hr/> <hr/>
5	Record the results in a table.

SCORE	4
-------	---

- 33 Daniel kept a green plant in the dark for two days. He then carried out an experiment on one of its leaf as shown below. The plant was placed under sunlight for some time.

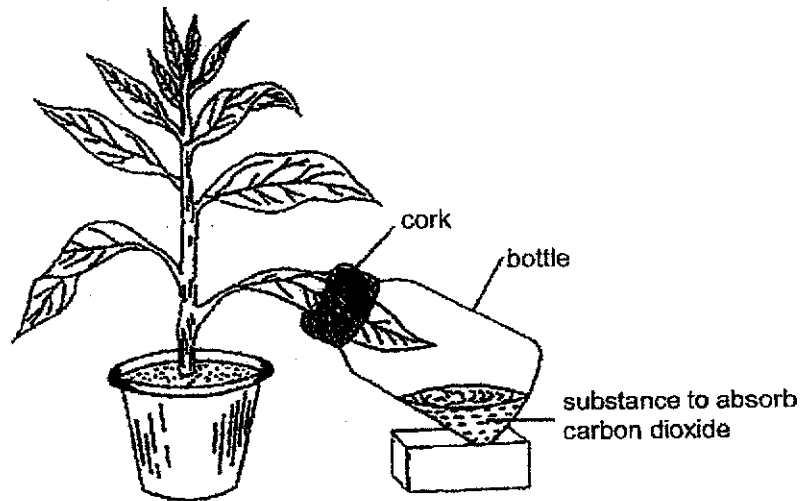

- (a) Daniel plucked the leaf from the plant and performed the starch test. He added a few drops of iodine solution to each part of the leaf as shown below. Iodine solution turns from brown to dark blue in the presence of starch.

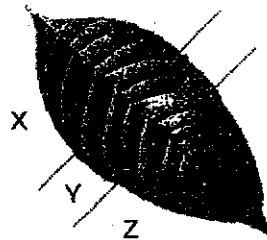

At which part(s) of the leaf, X, Y or Z, did the iodine solution remain brown? [2]
Explain why.

(Question 33 continues next page)

(b) Why did Daniel keep the plant in the dark for two days at the start of the experiment?

[1]

Daniel carried out another experiment as shown below.

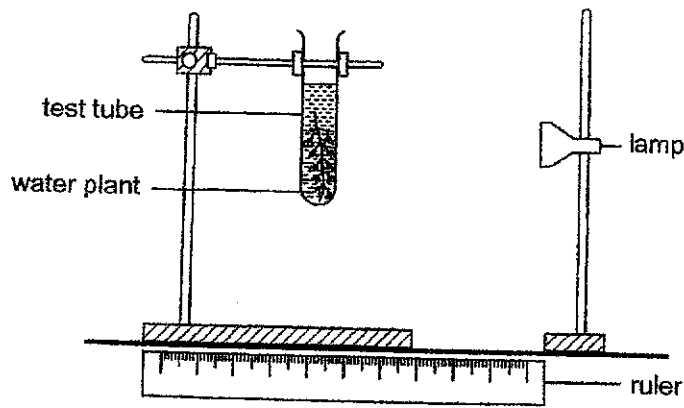

After a few hours, bubbles were observed in the test tube. The results of his experiment are as shown in the graph below.

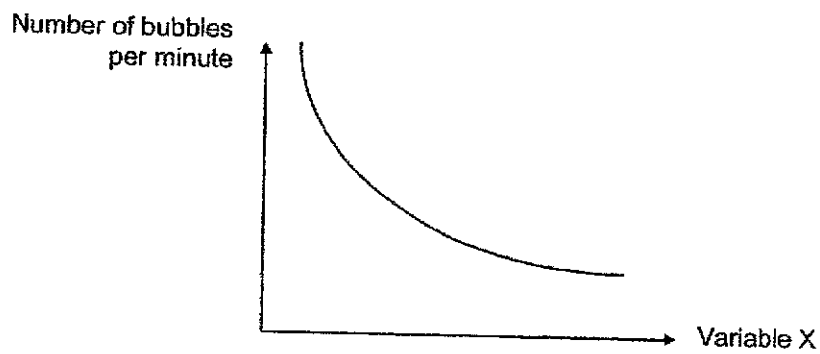

(c) Based on information given, suggest what variable X could be. Explain your answer. [2]

SCORE	5
-------	---

34 The graph below shows how Nadia's heart rate changed with time when she ran for a short while from rest.

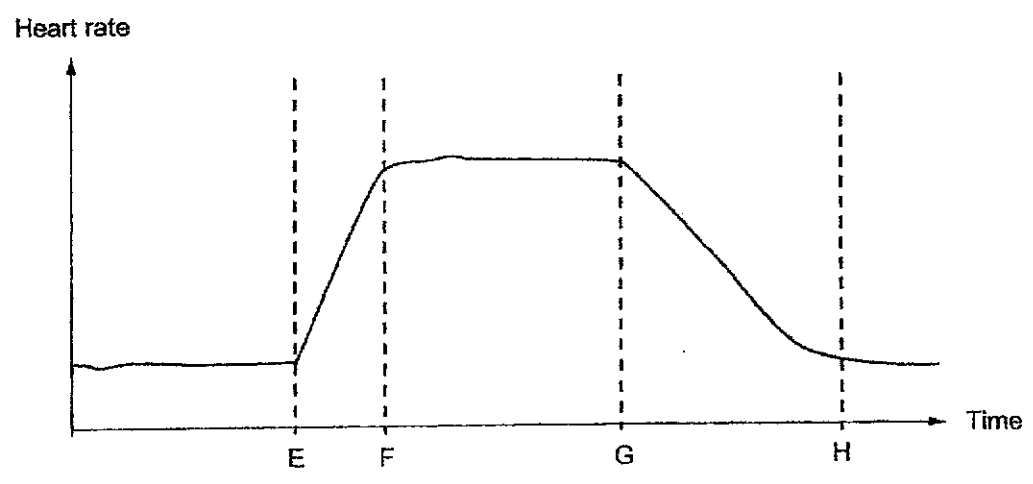

(a) Based on the graph, state the starting and ending time (E, F, G, H) of her run. [1]

Starting point: _____
Ending point: _____

(b) Describe how oxygen in the surroundings reaches the muscles in Nadia's legs. [2]

SCORE	3
-------	---

- 35 A librarian uses the set-up shown below to count the number of adult visitors passing through the entrance of a library. This entrance allows only one person to pass through at a time.

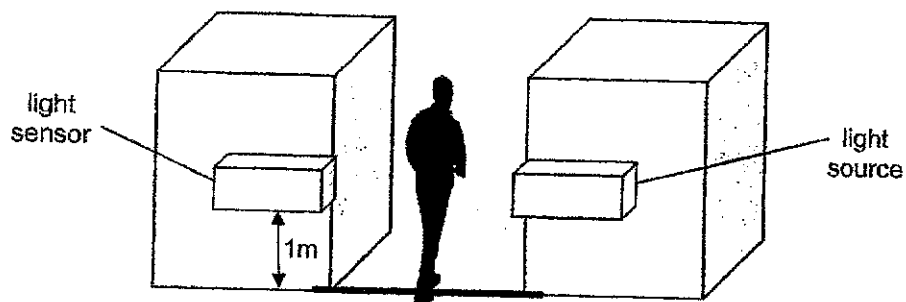

The light sensor can only detect one person at a time. A sample data recorded is shown in the graph below.

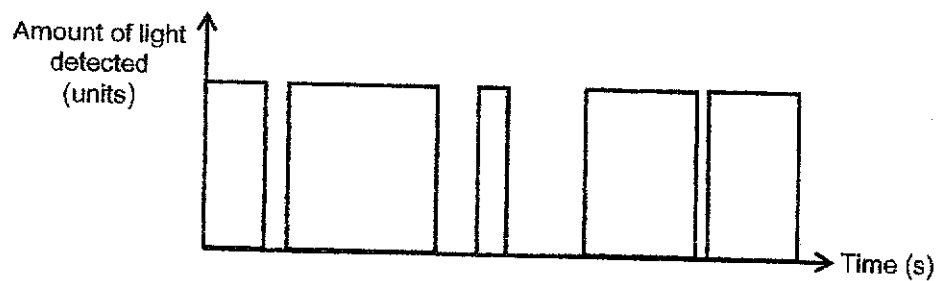

- (a) State the property of light that allows the set-up to perform its function. [1]
-
- (b) Based on the graph above, how many visitors went through the entrance? [1]
-
- (c) Based on the graph, explain how the librarian could tell that some visitors were walking slower than others when passing through the entrance of the library. [1]
-
-

SCORE	3
-------	---

- 36 Amanda bought an electric iron to iron clothes. The base of the electric iron has a heating coil and it becomes hot when the iron is switched on.

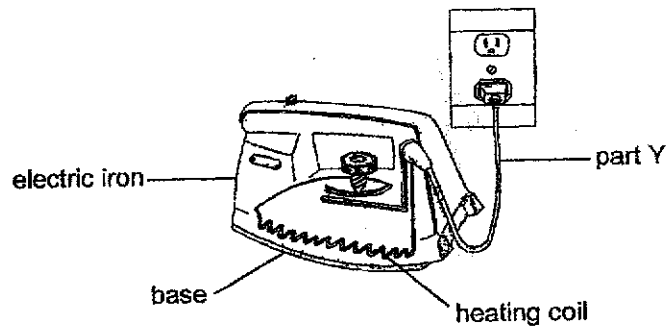

The diagram below shows how the circuit is connected to the heating coil found in the base of the electric iron.

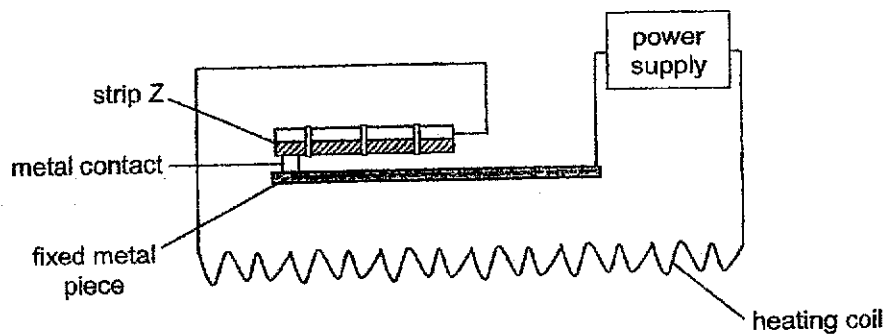

- (a) Metals are commonly used to make the base of the iron. Explain why. [1]
-
- (b) Part Y is covered with rubber. State the property of rubber that makes it safe for this use. [1]
-

(Question 36 continues next page)

Strip Z is made of two different types of metals. The diagram below shows what happens to strip Z as it expands after five minutes of using the electric iron.

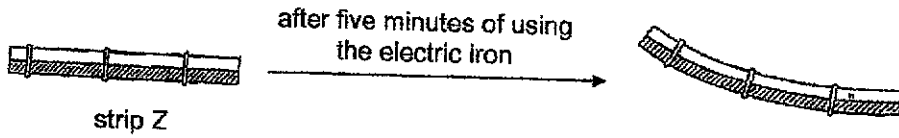

(c) Explain how strip Z helps to prevent the base of the electric iron from overheating after five minutes of usage. [2]

SCORE	4
-------	---

37 Wei Shan opened a freezer containing ice. Mist was seen as shown below.

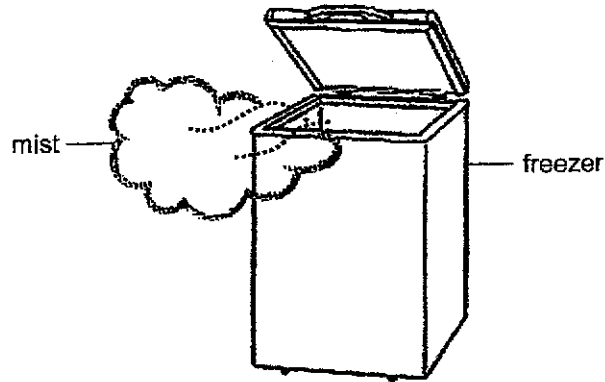

(a) Explain how the mist was formed. [2]

(b) Wei Shan observed that the mist disappeared after a short time. Explain why. [1]

SCORE	3
-------	---

- 38 Johan was given a circuit tester and a circuit card. He connected the circuit tester to the various points on the card.

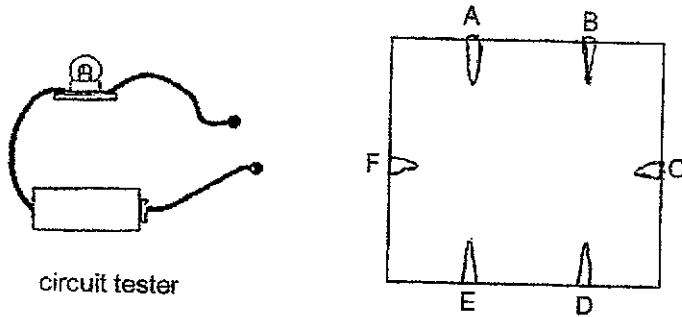

The results of his tests are listed below.

Connection between	Did the bulb light up?
A and B	Yes
B and C	No
B and D	Yes
B and E	No
B and F	Yes

- (a) Complete the results of the test in the table below.

[2]

Connection between	Did the bulb light up?
D and E	
C and F	

- (b) By drawing three lines only on each circuit card, complete two possible ways the points are connected on the circuit cards based on the results in (a).

[2]

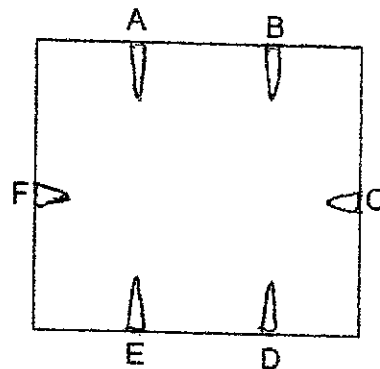
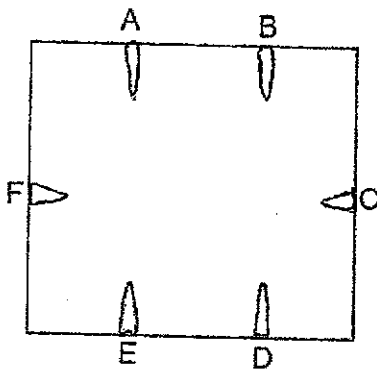

- 39 Siti conducted an investigation to find out how three different liquids, X, Y and Z, affect the temperature of the air inside a container. She soaked three pieces of cloth each in the same amount of liquids X, Y and Z. She wrapped the cloths around three similar containers, as shown in the diagram below.

Each container is connected to a datalogger to measure the temperature of the air inside the container after 10 minutes.

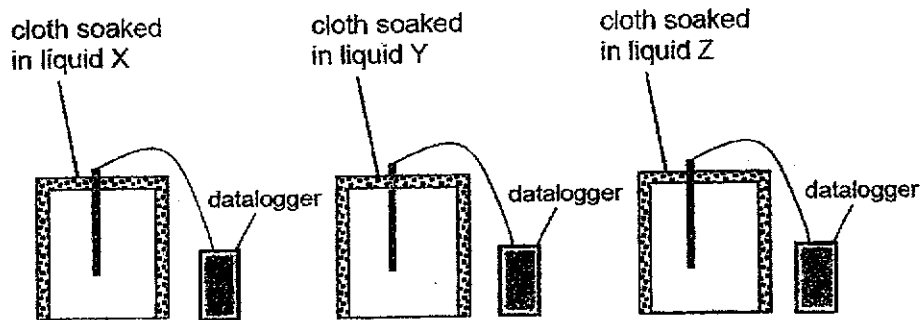

The graph below shows the results of her experiment.

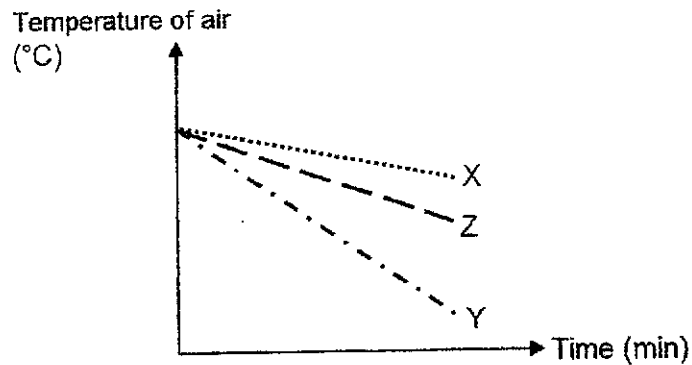

- (a) Based on the information given above, which liquid has the highest rate of evaporation? Explain your answer. [2]

(Question 39 continues next page.)

- (b) In some buildings, a water wall, which pumps water down the side continuously, is built to help cool the building when the weather is hot.

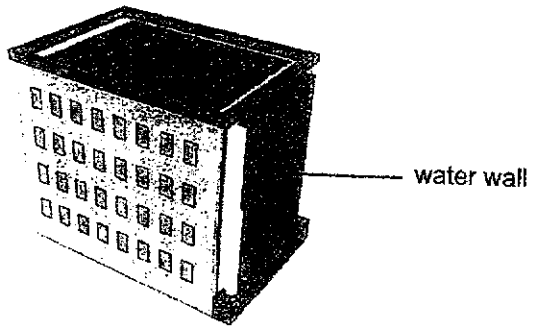

Based on the results of siti's experiment, explain how the water wall helps cool the building. [1]

SCORE	3
-------	---

- 40 The table below shows the melting point of different types of chocolate.

Type of chocolate	Melting point ($^{\circ}\text{C}$)
X	32
Y	41
Z	54

Pei Shi placed a chocolate cube on a heating plate at 40°C as shown below.

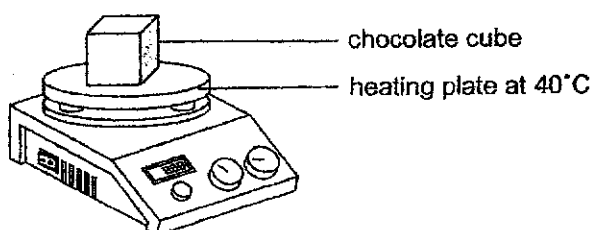

The chocolate cube turned into liquid after some time.

- (a) Based on the information above, which type of chocolate, X, Y or Z, could the chocolate cube be made of? Give a reason for your answer. [1]

Pei Shi has another chocolate cube made of chocolate Y and chocolate Z in the set-up shown below.

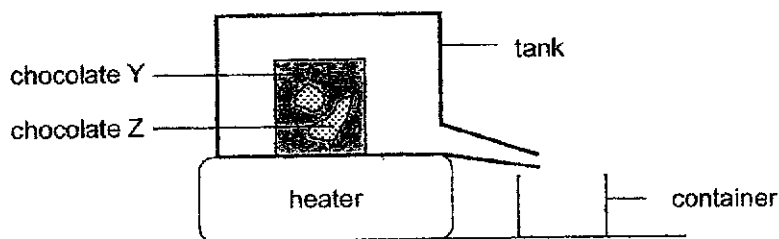

- (b) She wanted to obtain liquid chocolate made of chocolate Y only. Explain how she could use the set-up to do so. [2]

The diagram below shows how to make an ice-cream with a solid chocolate coating.

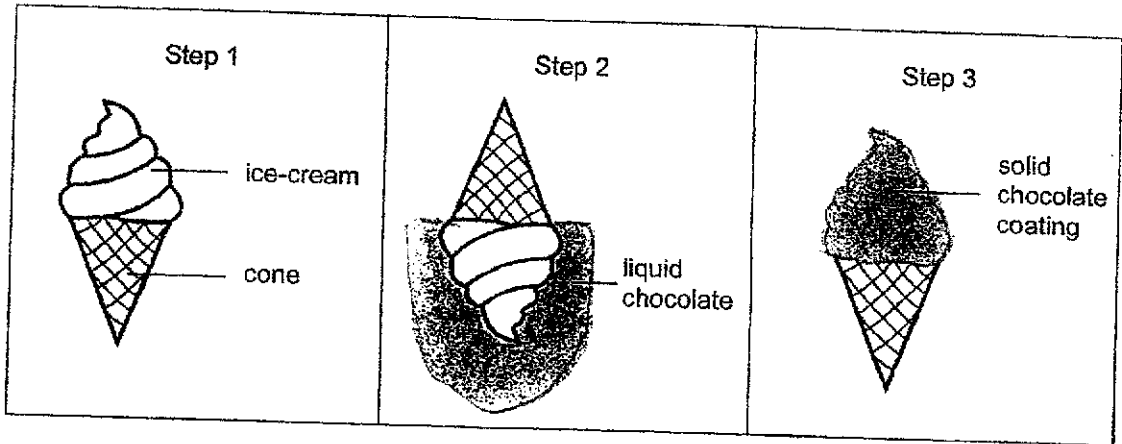

(c) Explain how the solid chocolate coating is formed on the ice-cream.

[1]

End of Paper

SCORE	4
-------	---

ANSWER KEY

YEAR : 2024
LEVEL : PRIMARY 5
SCHOOL : SCGS
SUBJECT : SCIENCE
TERM : EOY

Q1	2	Q2	3	Q3	1	Q4	4	Q5	4
Q6	1	Q7	4	Q8	1	Q9	3	Q10	1
Q11	2	Q12	4	Q13	3	Q14	1	Q15	2
Q16	2	Q17	4	Q18	4	Q19	2	Q20	3
Q21	1	Q22	2	Q23	2	Q24	3	Q25	1
Q26	3	Q27	4	Q28	3				

33	<p>(a) Y and Z. Part Y and Z could not carry out photosynthesis because Part Y did not receive sunlight while Part Z did not receive carbon dioxide. No glucose/food/sugar was produced and stored as starch.</p> <p>(b) To ensure that all starch in the leaf has been used up by the plant before the start of experiment.</p> <p>(c) Point 1 (identify variable): Distance of the lamp from the water plant. Point 2 As the distance of the lamp from the water plant increases, the light intensity decreases causing the rate of photosynthesis to decrease.</p>	
34	<p>(a) Starting point: E Ending point: G</p> <p>(b) When she breathes in, air enters her lungs/air sacs through her nostrils and windpipe. Oxygen from the inhaled air is absorbed into the blood. Heart pumps the oxygen-rich blood to the muscles/all parts of her body in her leg.</p>	

3

35	<p>(a) Light travels in a straight line</p> <p>(b) 4 visitors.</p> <p>(c) Those walking slower will block the light for a longer duration / time.</p>	
36	<p>(a) It is a good conductor of heat.</p> <p>(b) Rubber is an electrical insulator.</p> <p>(c) As strip Z expands, it bends away from the metal contact / bends and no longer touches the metal contact. An open circuit is formed, and the heating coil will stop heating.</p>	
37	<p>(a) The water vapour in the surrounding air condensed on the cooler air from the freezer.</p> <p>(b) The water droplets / mist gained heat from surroundings and evaporated.</p>	

38 (a) D and E – No
C and F – No

(b) Clip C and E must not be connected.

5

39	<p>(a) Liquid Y. The temperature of air in the container decreased at the fastest rate / is the lowest, showing that Liquid Y gained the most amount of heat from the air in the container during the given period of time.</p> <p>(b) Heat (from the Sun) was gained by the water to evaporate so less heat would be gained by the building.</p>	
40	<p>(a) X. Its melting point is lower than 40°C.</p> <p>(b) Heat the chocolate cube at 41°C / a temperature between 41°C and 54°C / heat the chocolate to Y's melting point so that (only) chocolate Y melts.</p> <p>(c) The liquid chocolate loses heat to the ice-cream, causing the chocolate to freeze.</p>	

4
END