



AI TONG SCHOOL

2024 END-OF-YEAR EXAMINATION
PRIMARY FIVE SCIENCE
(BOOKLET A)
21 OCTOBER 2024

Total time for booklets A and B : 1 h 45 min

INSTRUCTIONS

- Do not turn over this page until you are told to do so.
- Follow all instructions carefully.
- Answer all questions.

Name : _____ ()

Class : Primary 5 _____

Parent's Signature : _____

Booklet A	56
Booklet B	44
Total	100

Section A (28 x 2 marks)

For each question from 1 to 28, four options are given. One of them is the correct answer. Make your choice and shade the correct oval (1, 2, 3 or 4) on the Optical Answer Sheet.

1. The following table shows some information on three organisms, A, B and C.

A tick (✓) indicates the characteristics that the organism has.

Organism Characteristic	A	B	C
makes food on its own	✓		
bears flowers	✓		
moves from place to place on its own		✓	

Based on the table, which of the following correctly matches organisms A, B and C?

	A	B	C
(1)	fern	cat	eraser
(2)	tomato plant	eraser	fern
(3)	mushroom	eraser	cat
(4)	tomato plant	cat	mushroom

2. Study the diagram below.

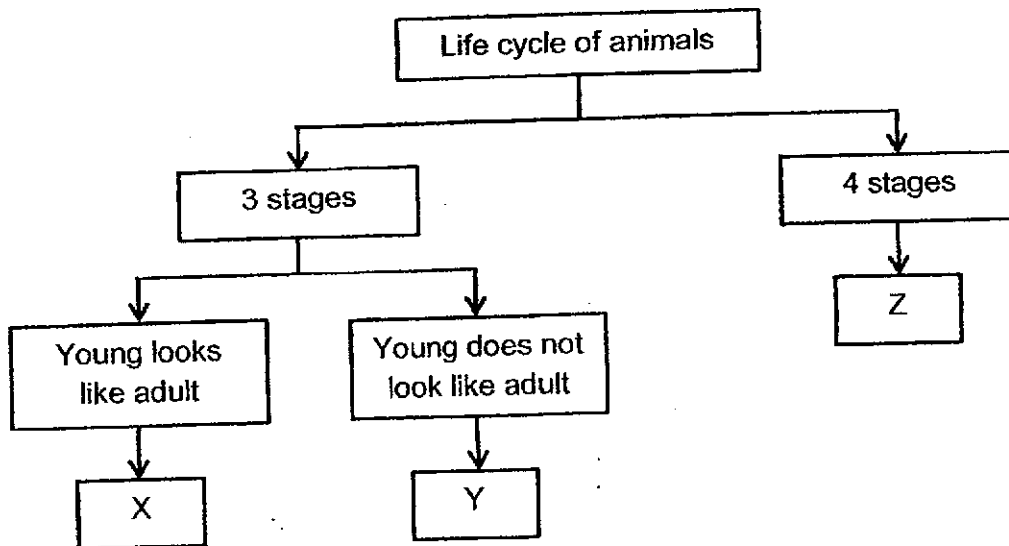

Which of the following represents X, Y and Z?

	X	Y	Z
(1)	mosquito	cockroach	mealworm beetle
(2)	grasshopper	frog	mosquito
(3)	cockroach	grasshopper	mosquito
(4)	frog	mealworm beetle	cockroach

3. The diagrams below show parts of the reproductive systems in a flower and human.

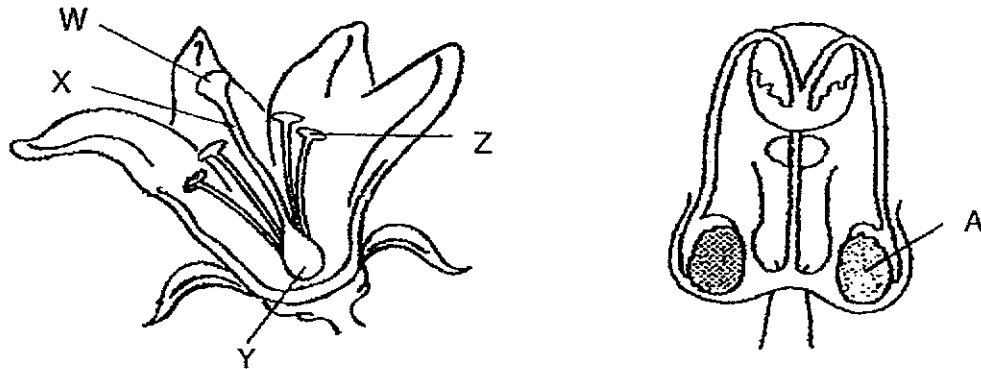

Based on the diagrams above, which part of the flower has a similar function as part A?

- (1) W
 - (2) X
 - (3) Y
 - (4) Z
4. The diagram below shows how food and water are transported to and from the different plant parts represented by R, S and T.

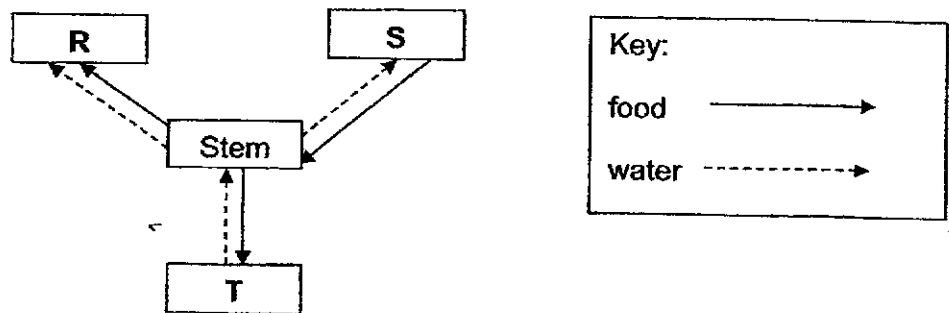

Which of the following parts of the plant are best represented by R, S and T?

	R	S	T
(1)	fruits	leaves	flowers
(2)	leaves	flowers	fruits
(3)	fruits	leaves	roots
(4)	leaves	flowers	roots

5. Adrian prepared four pots, P, Q, R and S, as shown in the table below.

Variables \ Pots	P	Q	R	S
Number of green bean seeds	10	5	5	5
Amount of water added to the seeds everyday (cm ³)	100	100	100	0
Location where the pot is placed	garden	garden	freezer	garden

He selected the following pots for each of the following experiment.

Set-ups	Pots	Aim of experiment
A	Q and S	To find out if water is needed for germination.
B	P and R	To find out if the presence of warmth affects germination.
C	P and Q	To find out if the number of seeds affects the rate of germination.
D	R and S	To find out if the amount of water affects germination.

Which of the following set-ups used will ensure a fair test?

- (1) A and C only
- (2) B and D only
- (3) A, B and C only
- (4) B, C and D only

6. Wei Ling coated all the leaves of a plant with a thick layer of waterproof black paint on both the upper and underside of the leaves. She then left the plant in the garden for a week.

What would likely happen to the plant after a week?

- A The plant will grow taller.
- B The leaves of the plant would start wilting.
- C The water-carrying tubes would be stained black.
- D The food-carrying tubes would not transport any food from the leaves.

- (1) A and C only
- (2) B and D only
- (3) C and D only
- (4) A, B and D only

7. Blood samples W, X, Y and Z were taken from different blood vessels A, B, C and D in the body.

The graph below shows the amount of carbon dioxide present in each of these blood samples.

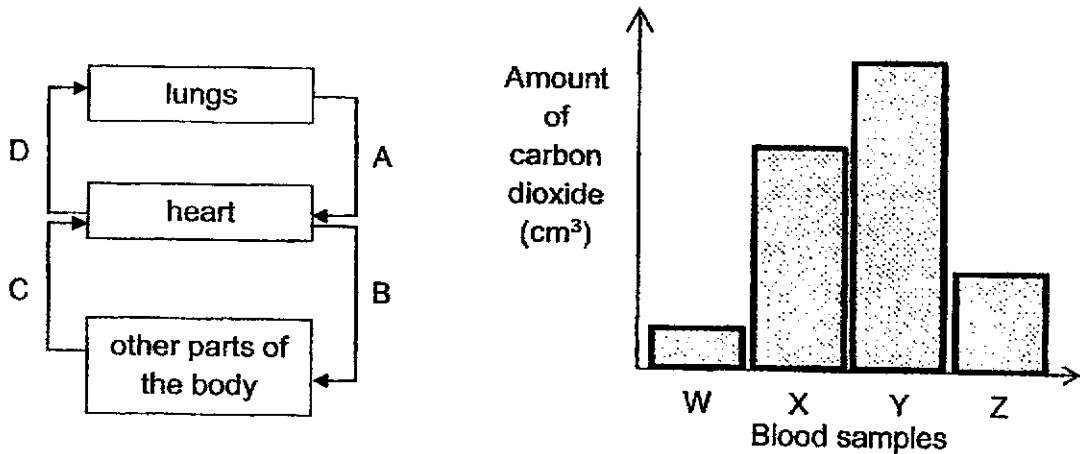

Which blood sample was most probably taken from the blood vessel D?

- (1) W
- (2) X
- (3) Y
- (4) Z

8. The table below compares statements about the plant transport system and human circulatory system.

	Plant Transport System	Human Circulatory System
A	Has tubes that transport materials	Does not have tubes to transport materials
B	Transports food and water produced by the leaves	Transports undigested food
C	Does not need anything to pump substances through the system	Has a heart to pump blood through the system
D	Transports water, dissolved mineral salts and food to all parts of the plant	Transports digested food, oxygen, carbon dioxide, water, and waste materials

Which of the above comparisons are **not** correct?

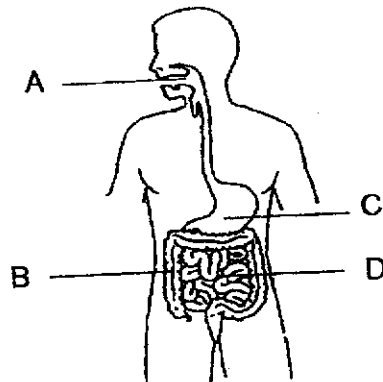

- (1) A and B only
 - (2) C and D only
 - (3) A, B and C only
 - (4) B, C and D only
9. The diagram below shows the human digestive system.





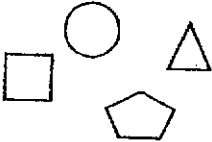

In which part A, B, C or D does the digested food enter the bloodstream?

- (1) A
- (2) B
- (3) C
- (4) D

10. Patrick examined some cells under the microscope and represented the parts of the cells with some symbols. He classified the parts of the cells in the classification table below.

Found in all plant cells	Found in all animal cells	Found in some plant cells
		

Which one of the following correctly represents the parts of the cells in each group?

				
(1)	Cell wall	Chloroplast	Nucleus	Cytoplasm
(2)	Cytoplasm	Nucleus	Cell wall	Chloroplast
(3)	Cytoplasm	Cell wall	Chloroplast	Nucleus
(4)	Nucleus	Chloroplast	Cell wall	Cytoplasm

11. Alan put together a set-up below to represent a cell. A tubing, tied tightly, is filled with blue water and is placed into a beaker of clear water. After a while, the tubing becomes swollen, and the blue water remains in the tubing.

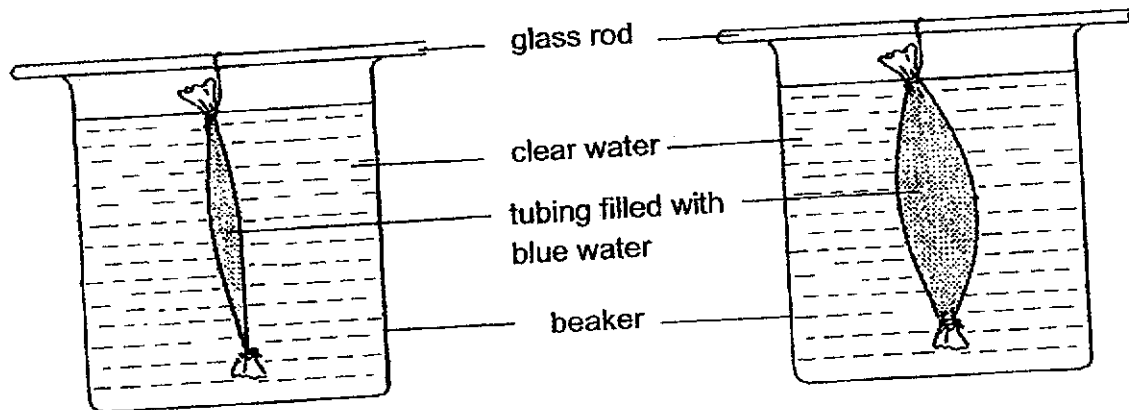

Which of the following conclusions can Alan make from this observation?

- A The tubing acts like a cell wall.
 - B The tubing represents a leaf cell.
 - C The tubing acts like a cell membrane.
 - D The tubing allows certain substances to enter.
- (1) A and B only
 (2) C and D only
 (3) A, B and D only
 (4) B, C and D only

12. Victor placed four similar pots of plants in a dark cupboard for two days. Then, he put each plant in four boxes, A, B, C and D, of the same size. The boxes were made of either material X or Y. Liquid S, which absorbs a gas, was placed in boxes A and C. The four boxes were then left in the sun for five hours.

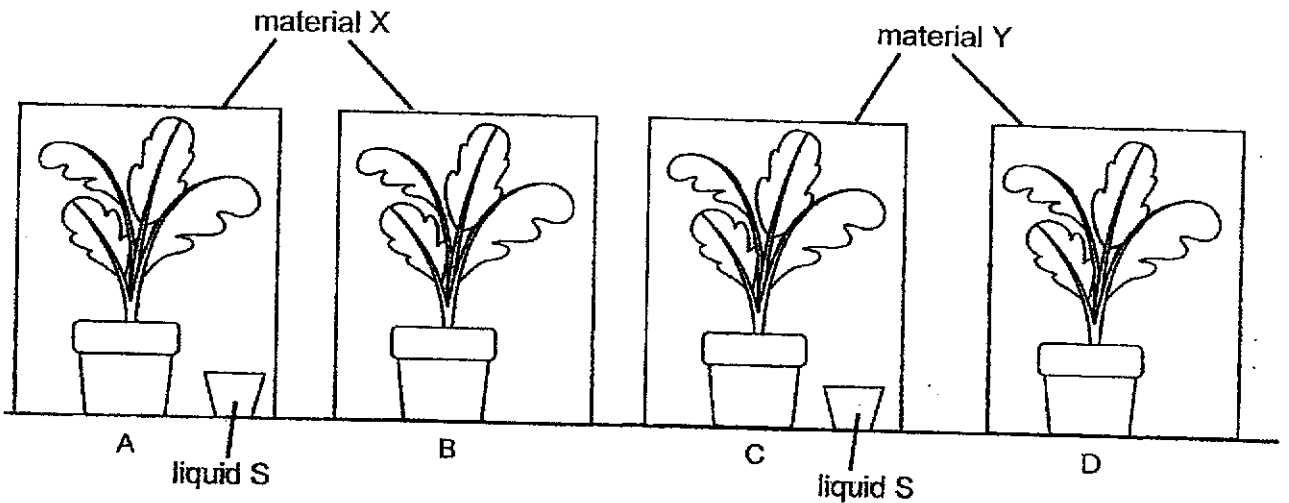

At the end of the experiment, Victor performed a starch test on a leaf from each the plant. Only the leaf from box D showed that starch was present.

Based on his observation, which statement(s) is/are definitely true?

- A Liquid S absorbs oxygen.
- B Liquid S absorbs carbon dioxide.
- C Material X allows light to pass through.
- D Both materials X and Y do not allow light to pass through.

- (1) B only
- (2) A and C only
- (3) A and D only
- (4) B and C only

13. The diagram below shows what a leaf looks like under a microscope.

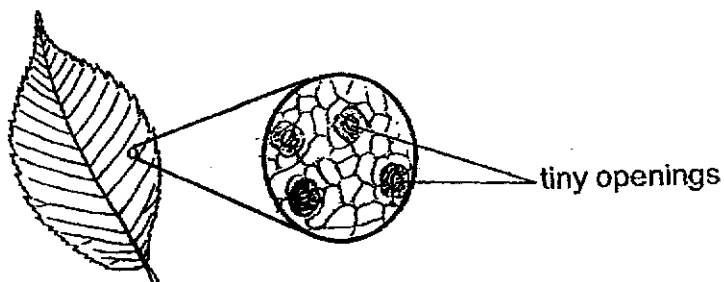

What are the functions of these tiny openings?

- A To absorb sunlight
 - B To allow oxygen to enter and leave
 - C To absorb water vapour for the plant
 - D To allow carbon dioxide to enter and leave
- (1) A and C only
 (2) B and D only
 (3) C and D only
 (4) A, B, C and D
14. Substance X was a liquid at 20 °C. It became a gas when it reached a temperature of 65 °C. Based on these observations, some statements about substance X were made and recorded in the table below.

Which of the following statements about substance X is correct?

	Statements	True	False	Impossible to tell
A	Substance X is a gas at 70 °C.		✓	
B	Substance X is a solid at 0 °C.			✓
C	Substance X is a liquid at 40 °C.		✓	
D	Substance X is a liquid at 67 °C.	✓		

- (1) A
 (2) B
 (3) C
 (4) D

15. Four children, Alan, Brian, Carol and Don did an experiment with a piece of clay. They made the following observations:

Alan When it is rolled, it becomes round like a ball.
Brian When it is lowered into a cylinder of water, the water level rises.
Carol When it is placed in an empty beaker, it does not change its shape.
Don When it is placed on one pan of a lever balance, the pan goes down.

Whose observation shows that the piece of clay takes up space?

- (1) Alan
 - (2) Brian
 - (3) Carol
 - (4) Don
16. Plastic bags for wet umbrellas are often provided at building entrances to keep the floor dry within the building on rainy days.

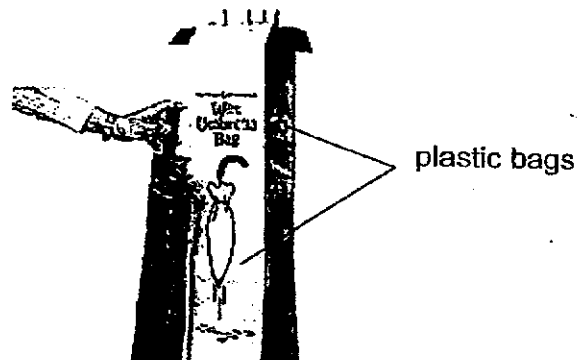

What are the two most important properties these plastic bags must have to serve its purpose?

- (1) Light and flexible
- (2) Light and transparent
- (3) Waterproof and flexible
- (4) Waterproof and transparent

17. Ibrahim was asked to select the most suitable materials for making electrical wires and the base of a cooking pan from the classification chart below.



Some materials were classified as shown below.

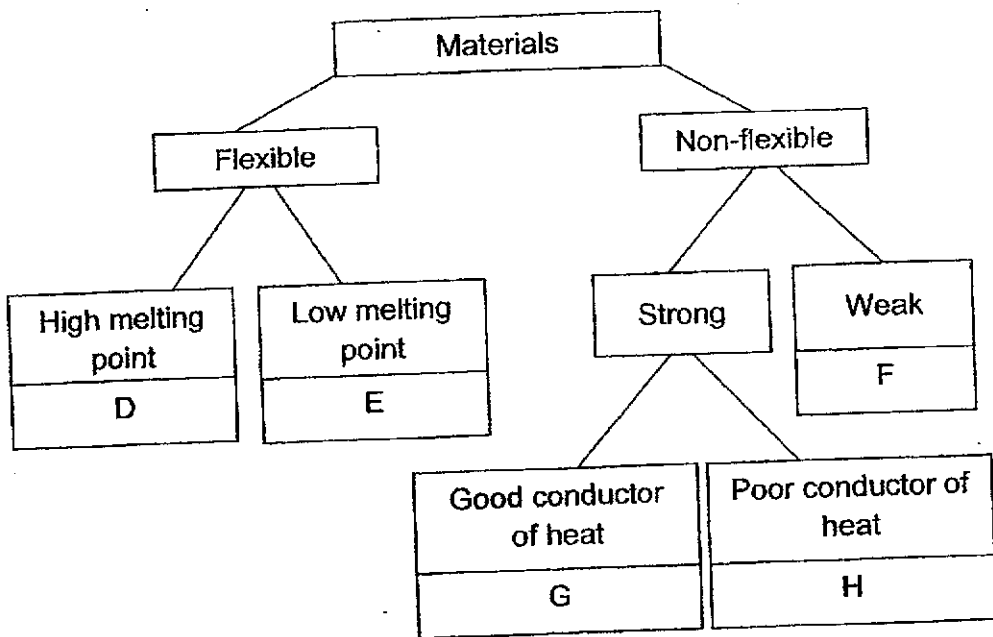

Based on the above classification chart, which of the following shows the best choice for making the electrical wires and the base of the cooking pan?

	Electrical wires	Base of the cooking pan
(1)	G	F
(2)	H	E
(3)	D	G
(4)	E	H

18. Study the set-up below.

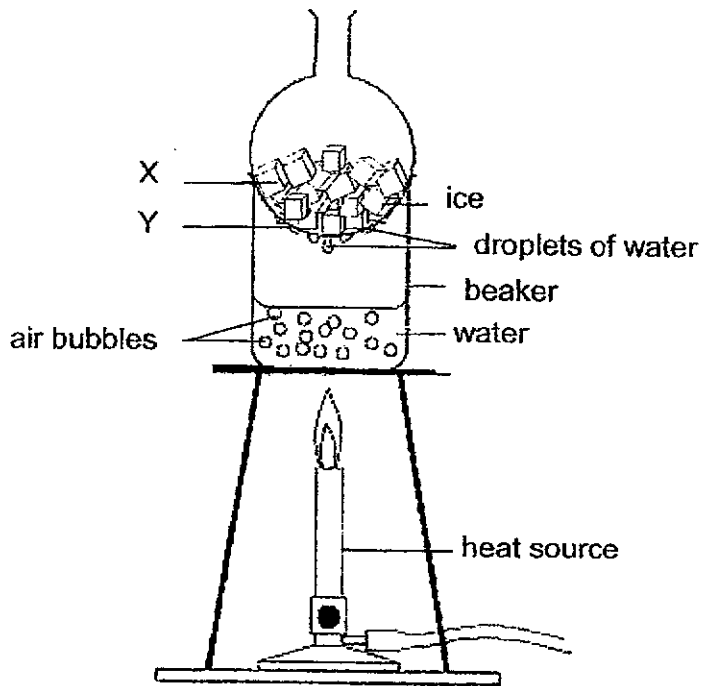

Identify the main processes occurring at X and Y.

	X	Y
(1)	Condensation	Melting
(2)	Condensation	Evaporation
(3)	Melting	Evaporation
(4)	Melting	Condensation

19. Kevin placed four containers of water, P, Q, R and S, at different locations under different conditions. The graph below showed how the volume of water in the containers changed with time.

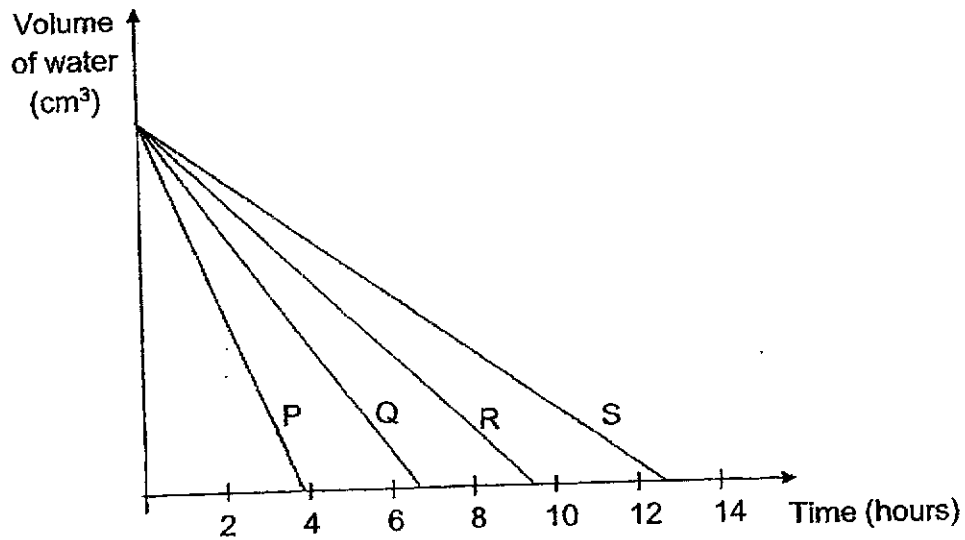

Which statement made by Kevin is correct?

- (1) S was placed in a warmer location than Q.
- (2) P is placed in a location that has more wind than R.
- (3) The exposed surface area of the water in S is bigger than that of P.
- (4) The amount of water in S evaporated more than the water in P after two hours.

20. Which one of the following graphs shows the correct relationship between the two variables stated in the graphs?

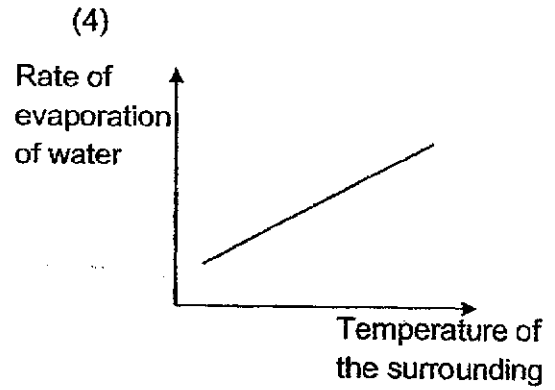
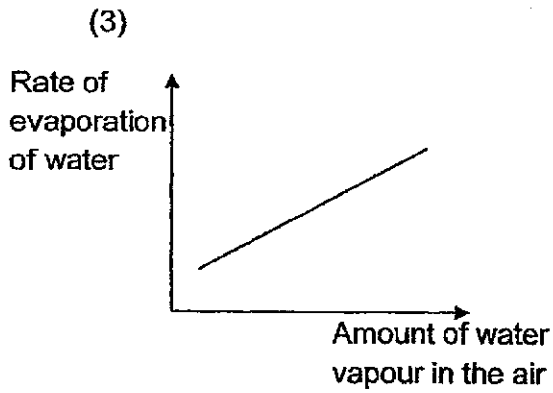
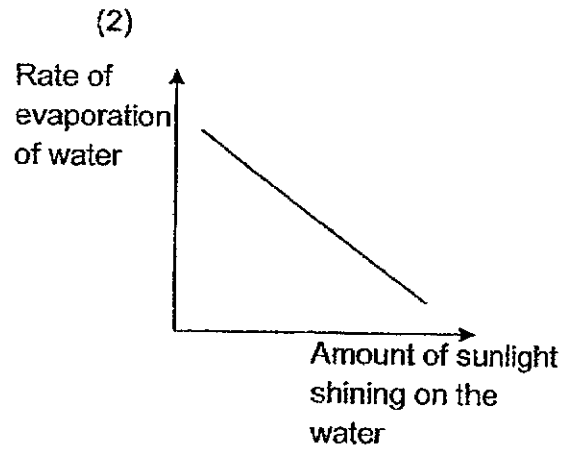
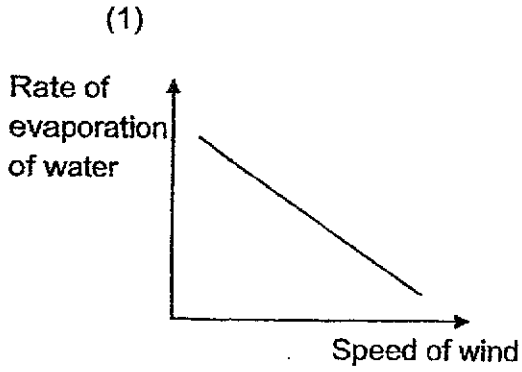

21. Justin set up four circuits using identical bulbs and batteries in working condition.

A

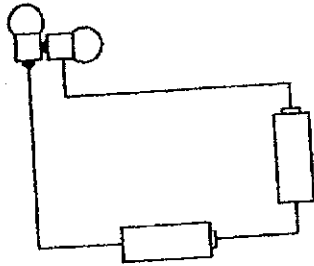

B

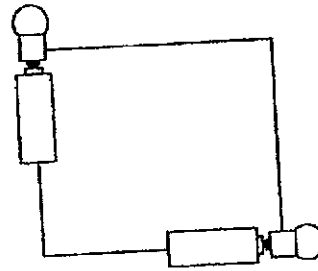

C

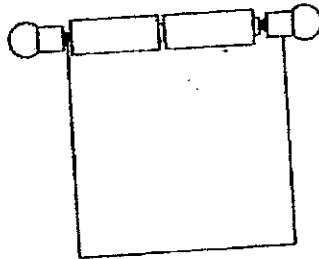

D

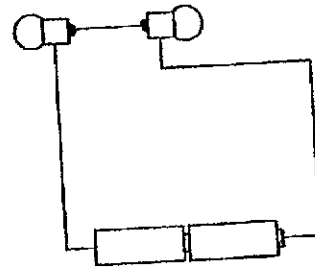

Which circuit(s) will have at least one unlit bulb?

- (1) A only
- (2) B and C only
- (3) A and D only
- (4) B, C and D only

22. Ivan had three rods, P, Q and R, made of different materials. He placed them in various positions, A, B and C, in the circuit shown below.

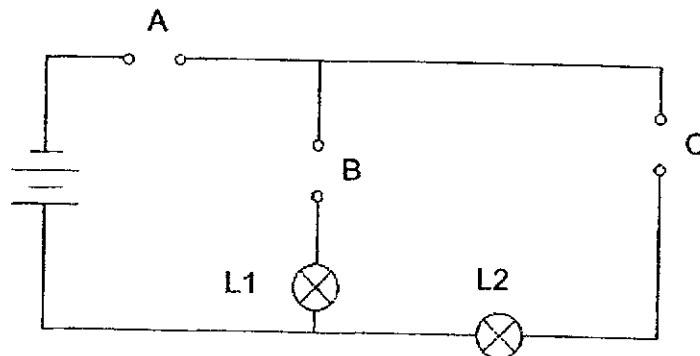

The results of the experiment are shown in the table below. A tick (✓) in the box indicates that the light bulb was lit up.

Positions where rods were placed			Light bulbs	
A	B	C	L1	L2
R	P	Q		
Q	R	P		✓
P	Q	R	✓	

Which one of the following statements is most likely to be true?

- (1) Only rod Q is a conductor of electricity.
- (2) Only rods P and Q are conductors of electricity.
- (3) Only rods P and R are non-conductors of electricity.
- (4) Only rods P and Q are non-conductors of electricity.

23. Phil set up circuits A, B, C and D using identical batteries and bulbs. All the bulbs and batteries are in good working condition.

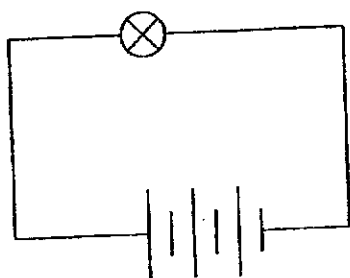

Circuit A

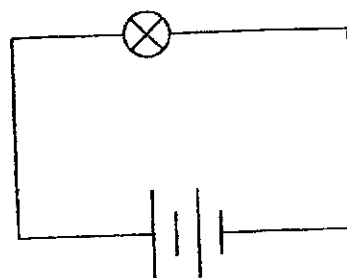

Circuit B

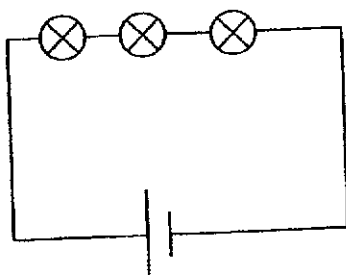

Circuit C

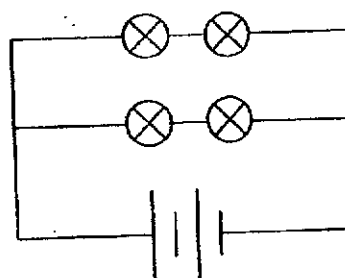

Circuit D

Which one of the following correctly shows the brightness (dimmiest to brightest) of the bulbs in circuits A, B, C and D?

	Dimmiest → Brightest			
(1)	A	B	D	C
(2)	B	D	C	A
(3)	C	D	B	A
(4)	D	C	A	B

24. The diagram below shows a closed circuit with both bulbs lighted up. Which components can be placed at A and B of the circuit without changing the brightness of bulb X?

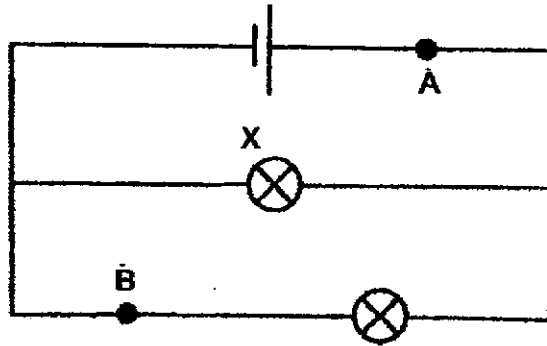

	A	B
(1)		
(2)		
(3)		
(4)		

25. Gavin was given some ring magnets, a light-weight plastic disc and a wooden stand.

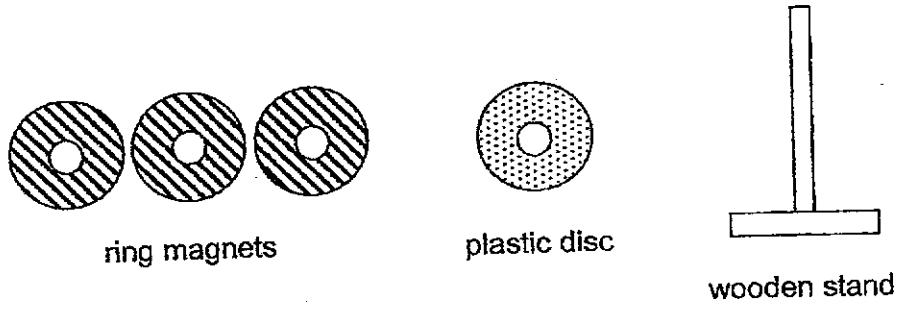

He placed the plastic disc and magnets one on top of the other through the wooden stand.

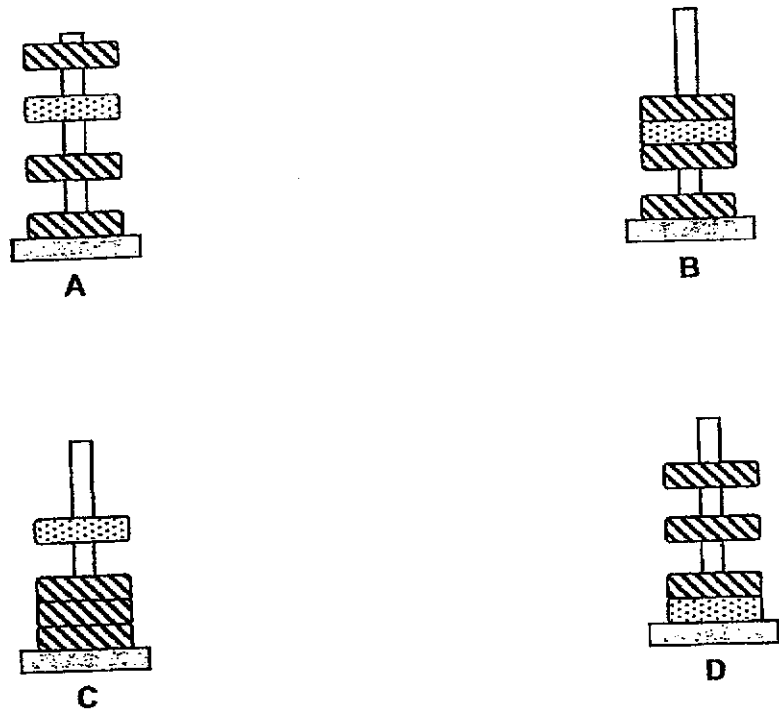

Which of the above arrangements would **not** be possible?

- (1) A and B only
- (2) B and D only
- (3) A and C only
- (4) A, C and D only

26. A mixture of materials P and Q was poured into machine Z. This machine can separate materials based on their magnetic properties. The arrows show the direction the belts on the rollers are moving in.

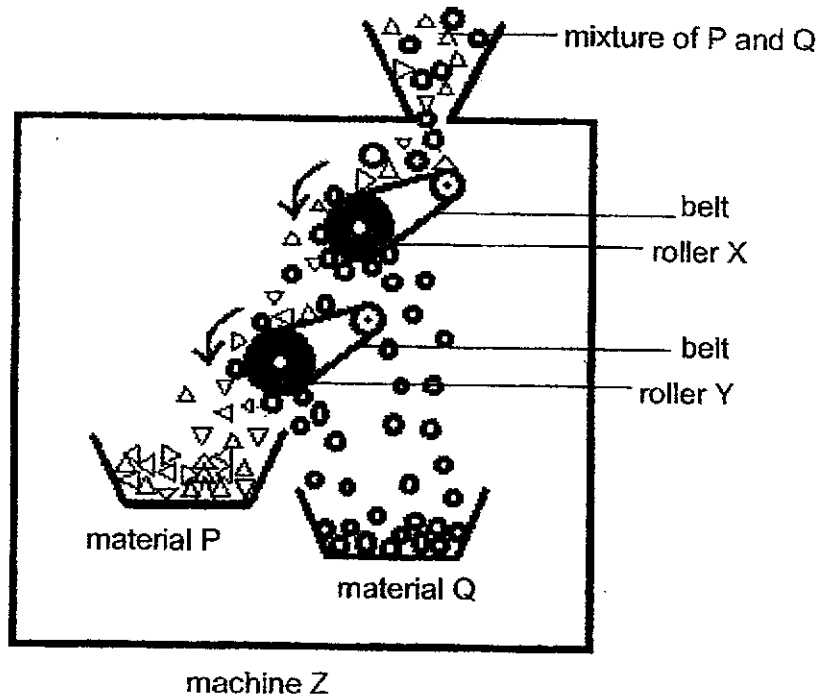

Based on the diagram above, which statements are true?

- A Material P is a magnetic material.
 - B Material Q is a magnetic material.
 - C Both rollers X and Y contain a magnet.
 - D Any mixture of metal and non-metal can be separated by this machine.
- (1) A and C only
 (2) A and D only
 (3) B and C only
 (4) B, C and D only

27. The diagram below shows the shadows produced when three objects were placed at different positions between a screen and a torch at any one time.

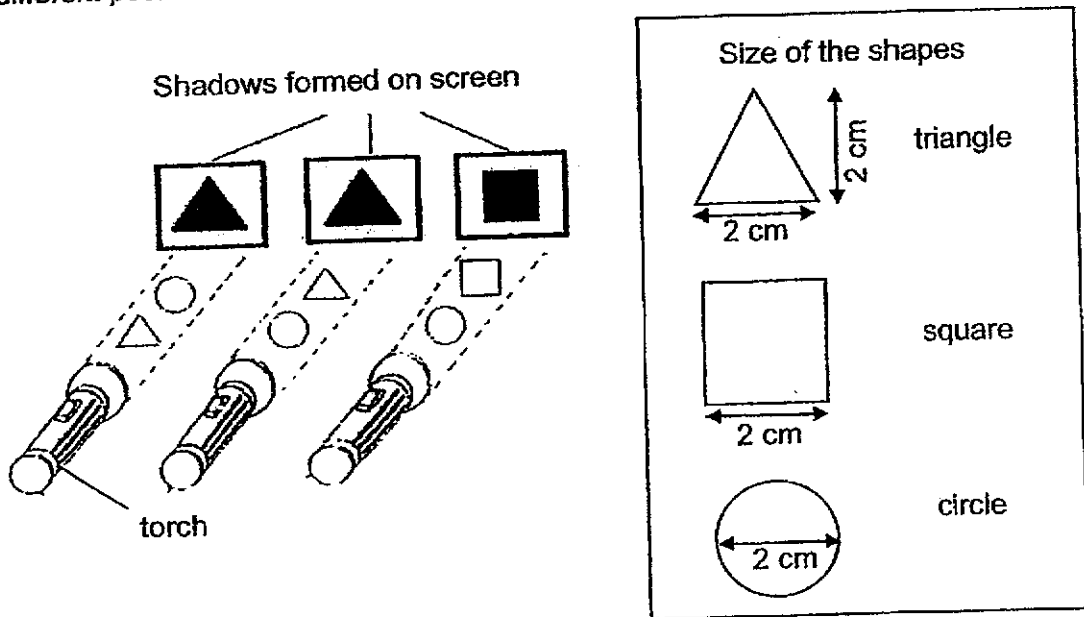

A hole is then cut from the square object. The square, triangular and circular objects are then set up as shown in the diagram below.

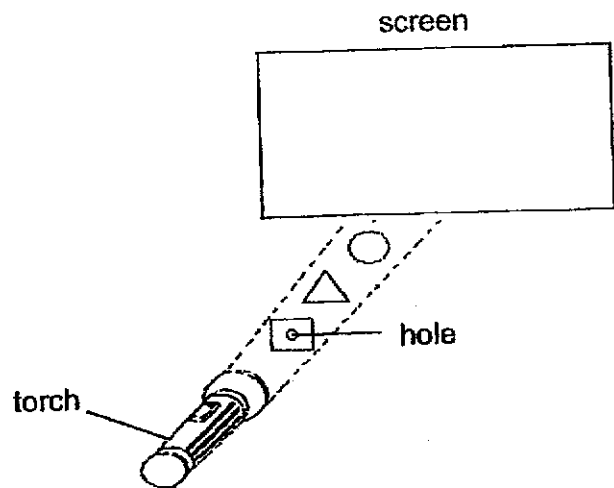

Which one of the following shadows will appear on the screen?

- | | |
|-------------|-------------|
| <p>(1) </p> | <p>(2) </p> |
| <p>(3) </p> | <p>(4) </p> |

28. The diagram below shows a set-up of a torch, a toy and a screen. All the items of the set-up can be moved.

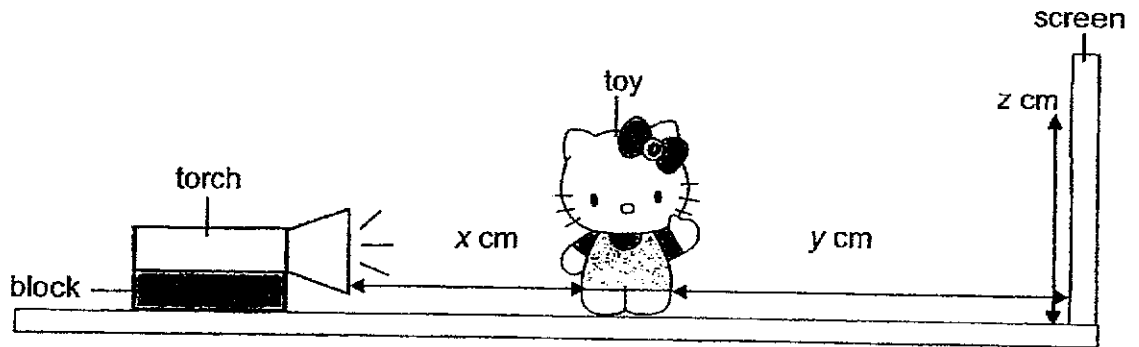

Which of the following is correct when the distances x and y are changed?

	Distance between the torch and the object (x cm)	Distance between the object and the screen (y cm)	Height of the shadow on the screen (z cm)
(1)	increase	decrease	remain the same
(2)	remain the same	decrease	decrease
(3)	decrease	increase	decrease
(4)	increase	remain the same	increase

~ End of Booklet A ~



AI TONG SCHOOL
2024 END-OF-YEAR EXAMINATION
PRIMARY FIVE SCIENCE

(BOOKLET B)

21 OCTOBER 2024

Total time for booklets A and B : 1 h 45 min

INSTRUCTIONS

Do not turn over this page until you are told to do so.

Follow all instructions carefully.

Answer all questions.

Write your answers in this booklet.

Name : _____ ()

Class : Primary 5 _____

Parent's Signature : _____

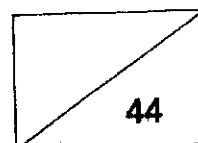

Section B: 44 marks

Read the questions carefully and write down your answers in the spaces provided.

29. Meiyin wanted to find out if moisture was needed for bread mould to grow. She prepared two set-ups, P and Q, using different types of bread of the same size, as shown below.

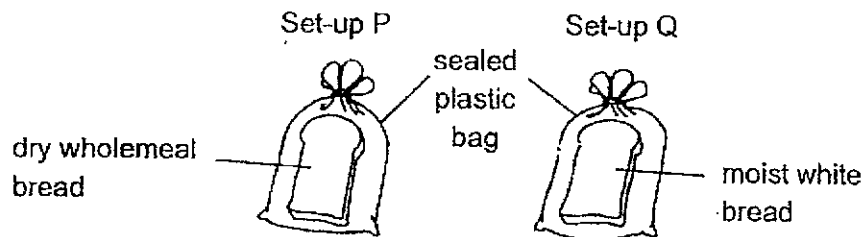

The table below shows the variables of Meiyin's experiment.

Variables	Set-up P	Set-up Q
Type of bread	wholemeal bread	white bread
Amount of water poured on bread (ml)	0	5
Location of the experiment	dark cupboard	dark cupboard
Type of plastic bag	transparent	transparent

- (a) Meiyin's mother told her that her experiment was not a fair one. Explain why her mother said so. [1]

- (b) Meiyin heeded her mother's advice and corrected her set-ups to make her experiment a fair one. In which set-up, P or Q, would bread mould appear first? Explain your answer. [1]

- (c) After her experiment, Meiyin was told that she could no longer eat the bread. Meiyin concluded that all fungi are harmful. Is her statement correct? Explain your answer. [1]

(Go on to the next page)

30. Mr Ali removed an outer ring at Y from the stem of a plant. The diagram below shows the close-up view of the stem.

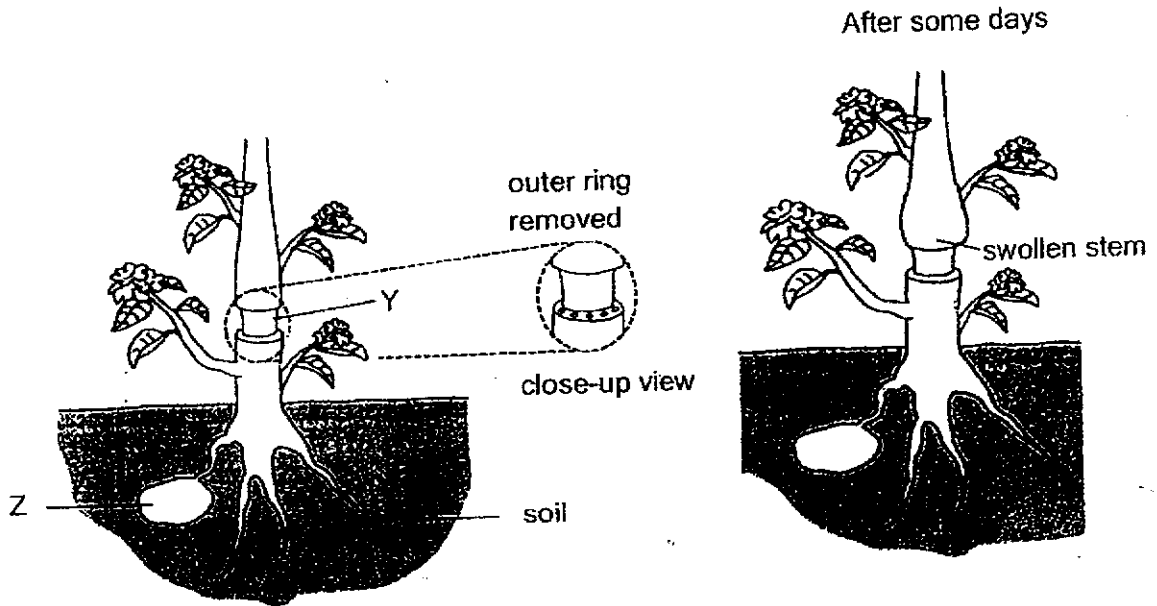

(a) After some days, it was observed that the stem above the cut-out section have grown bigger than the stem below Y. Explain why. [1]

(b) Part Z is where the plant stores its food. Will it grow bigger, smaller or remain the same over time after the outer ring of the stem is removed? Explain why. [1]

Question 30 continues on the next page.

(Go on to the next page)

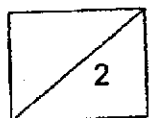

Question 30 continues on this page.

Mr Ali decided to make a deeper cut in the stem of the plant at Y, removing both the inner and outer rings in the stem. He wanted to see how this would affect his plant.

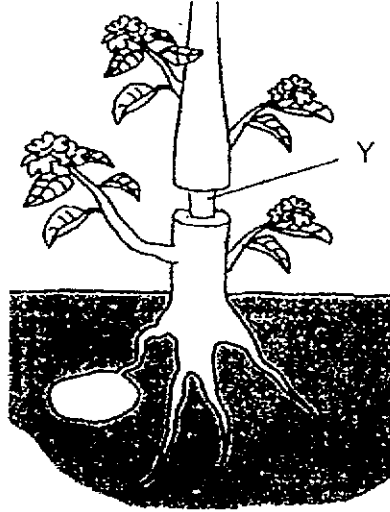

- (c) After some days, what would Mr Ali observe about the leaves above Y? Explain why.

[1]

(Go on to the next page)

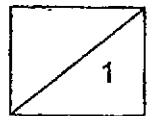

31. The diagram below shows two fruits, A and B, dispersing their seeds when the fruit wall splits.

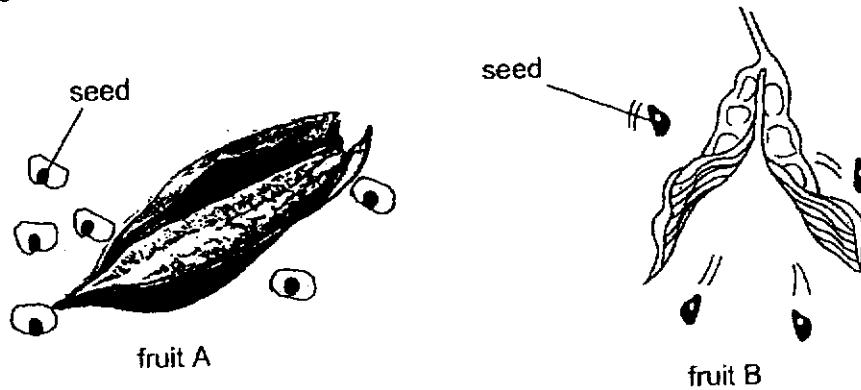

(a) It is observed that fruit A dispersed its seeds further away from its parent plant than fruit B. Based on your observation of the seeds, give a possible reason for this. [1]

(b) Explain how dispersing seeds further away from its parent plant help plant A survive better. [1]

(c) Explain how growing on tall trees and having fruits grow mainly at the top of the tree provide an advantage for the dispersal of the seeds of fruit A. [1]

(d) During the rainy season, the number of seeds and the distance the seeds are dispersed by fruit A decreases. Suggest a possible reason why this is so. [1]

(Go on to the next page)

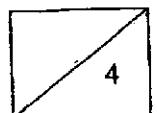

32. The diagram below shows how blood is circulated in our body.

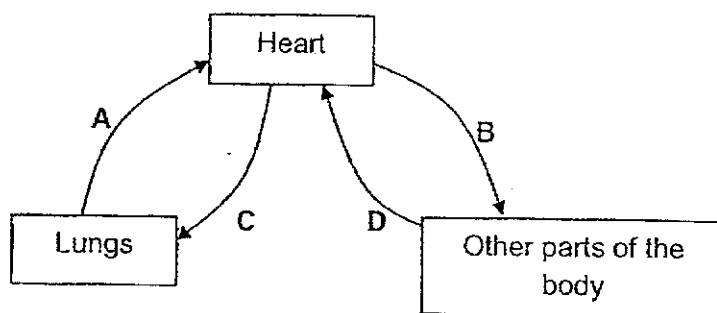

- (a) The blood at blood vessel D contains a greater amount of substance X than blood vessel at B. What is this substance X? [1]

Rani exercised for 30 minutes. The graph below shows her heart rate during her activity.

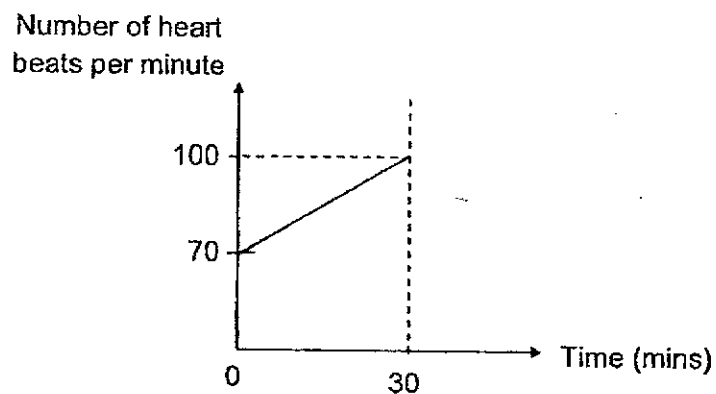

- (b) Explain why there was an increase in Rani's heart rate when she exercised. [2]

(Go on to the next page)

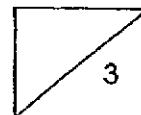

33. The diagrams below show the lungs in a human and the gills in a fish. Both organs help the two organisms to breathe.

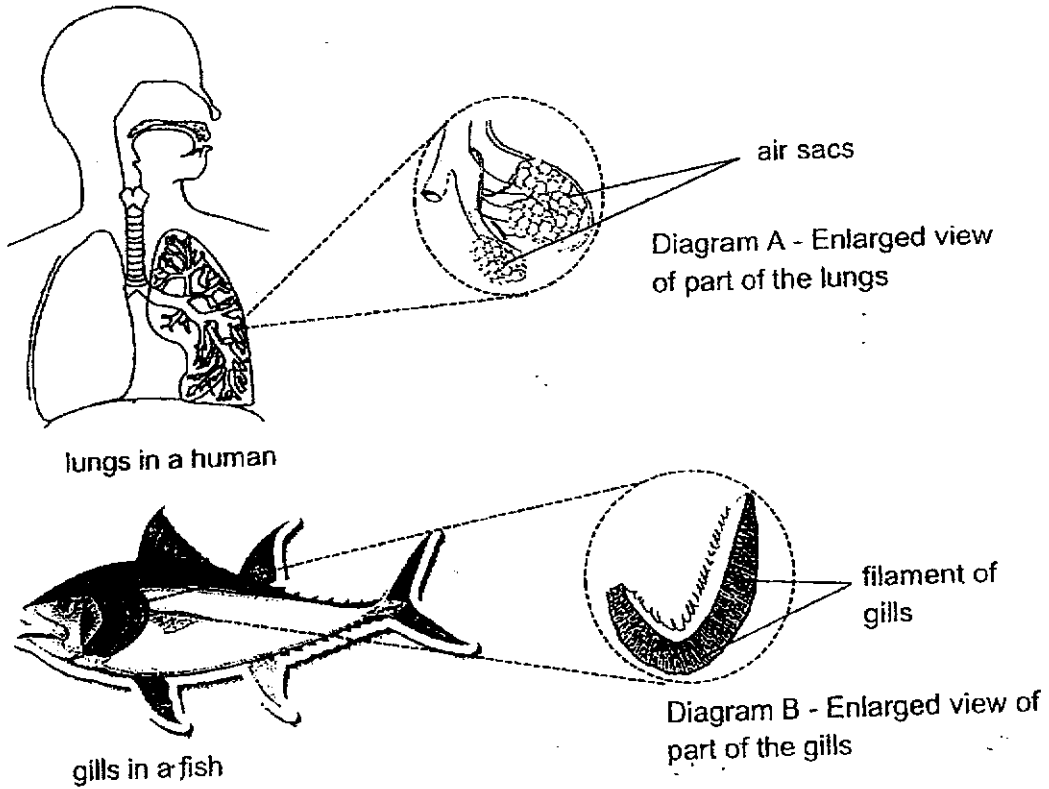

- (a) State a difference in the way the lungs and the gills obtain air from the surroundings. [1]
-
-
- (b) Describe one similarity in the way the structures in diagrams A and B help to allow gaseous exchange to take place quickly. [1]
-
-

Question 33 continues on the next page.

(Go on to the next page)

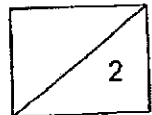

Question 33 continues on this page.

It was observed that the amount of dissolved oxygen in water is affected by temperature of water, as shown in graph A. Dolly recorded the number of times the gill cover of a fish flaps per minute as temperature of water changes in graph B.

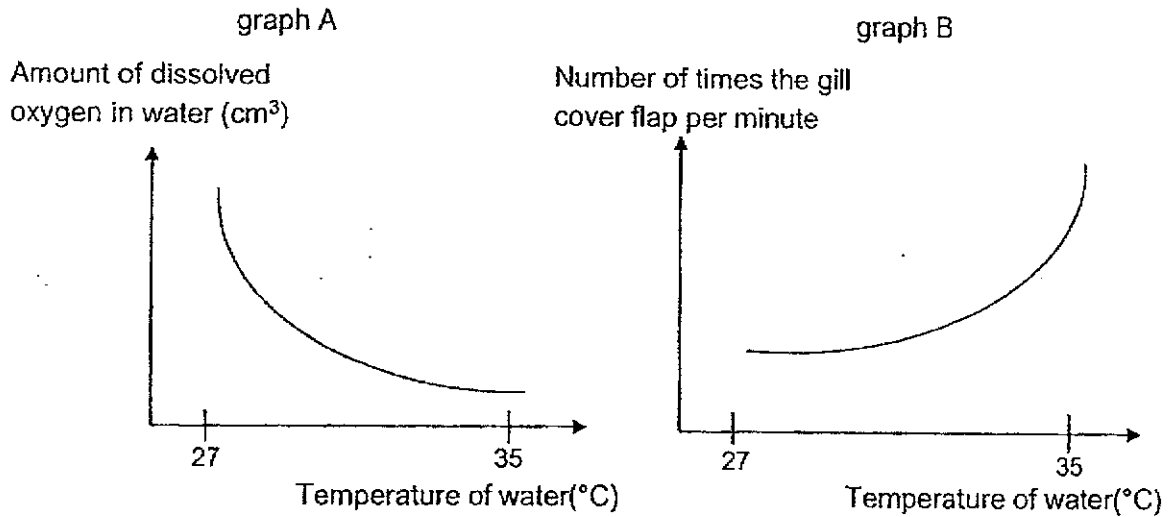

- (c) Based on the two graphs shown above, explain why a fish flaps its gill cover the most during the hottest time of the day. [1]

(Go on to the next page)

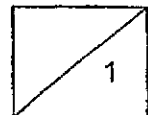

34. Javier set up an experiment under the sun as shown below. He wants to investigate how the presence of light affects the rate of photosynthesis of a plant.

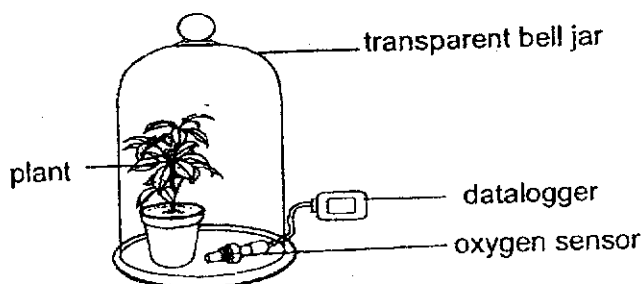

The diagram below shows two different types of cells, X and Y, taken from the plant in the above set-up.

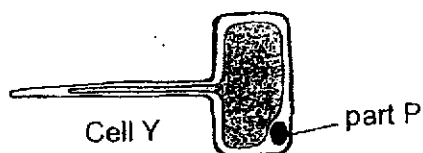

- (a) Name part P. [1]
- _____
- (b) Which cell, X or Y, is not able to produce oxygen? Explain your answer. [1]
- _____
- _____
- (c) The oxygen sensor measures the amount of oxygen given out by the plant. How does the rate of photosynthesis of the plant affect the amount of oxygen produced? [1]
- _____
- _____
- (d) Javier's teacher told him that he would not be able to draw a conclusion for the experiment. Javier should include a control set-up. What items should he use for his control set-up? [1]
- _____
- _____

(Go on to the next page)

35. Roy cut some leaves into little discs and conducted an experiment in a dark room using the set-up below. The intensity of light, amount of water and carbon dioxide were kept the same throughout the experiment. He measured the amount of gas Z collected in the syringe after some time.

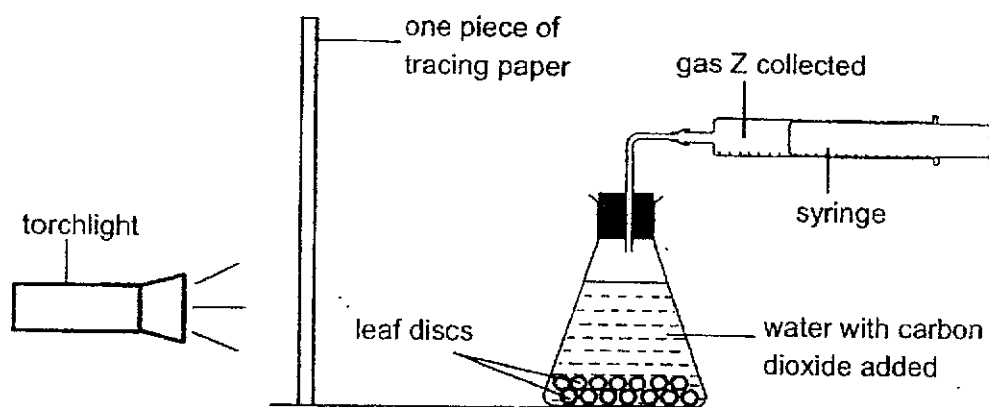

- (a) At the end of the experiment, Roy noticed that the leaf discs were covered with bubbles and have floated to the top of the water in the flask. What do these bubbles contain? [1]

Roy repeated his experiment by increasing variable X while keeping all the other variables constant. His results are shown in the graph below.

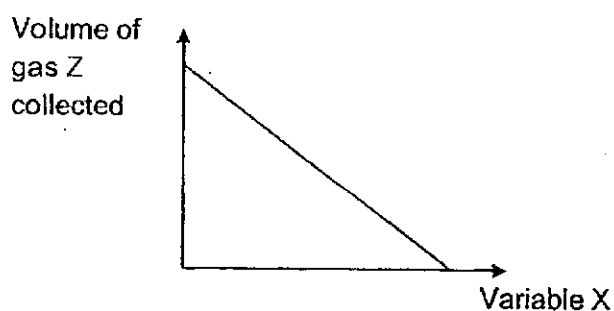

- (b) What could variable X be? Explain your answer. [2]

(Go on to the next page)

36. A toy ambulance is operated by two batteries. When the button is pressed, the lights on the ambulance will light up with two colours, red and blue as shown below.

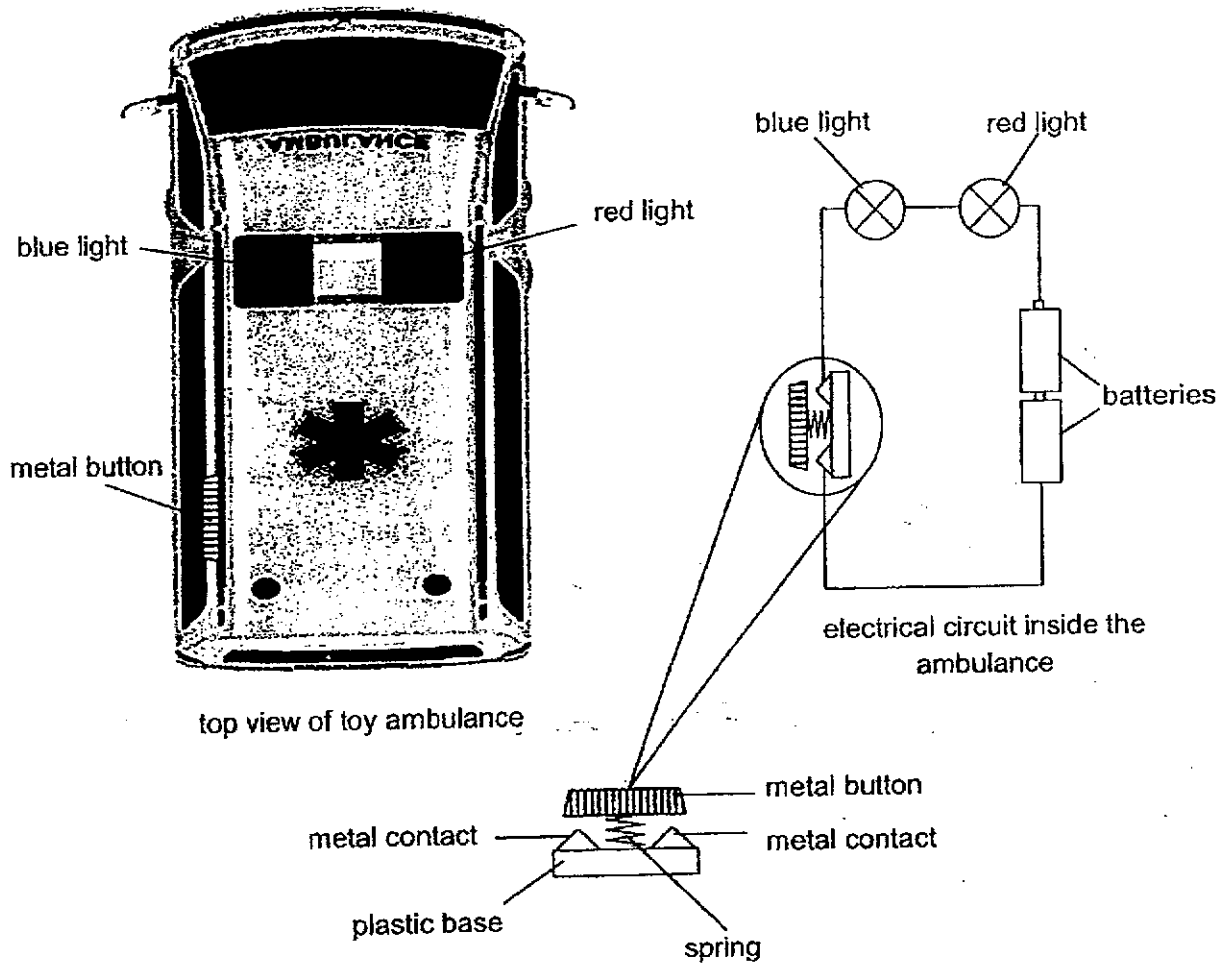

(a) Explain why the toy ambulance lit up when the button was pressed. [1]

Question 36 continues on the next page.

(Go on to the next page)

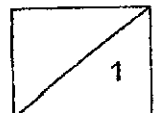

Question 36 continues on this page.

- (b) John wanted to create a toy ambulance such that the bulbs will light up as described in the table below.

Switch	Red bulb	Blue bulb
open	does not light up	lights up
closed	lights up	lights up

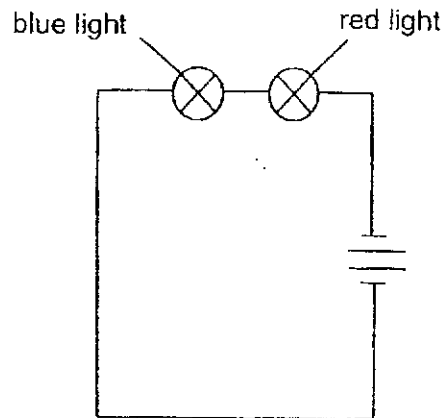

There were some mistakes made in his drawing. Identify the mistakes by drawing the correct circuit diagram in the space below. Label the colour of the bulbs. [3]

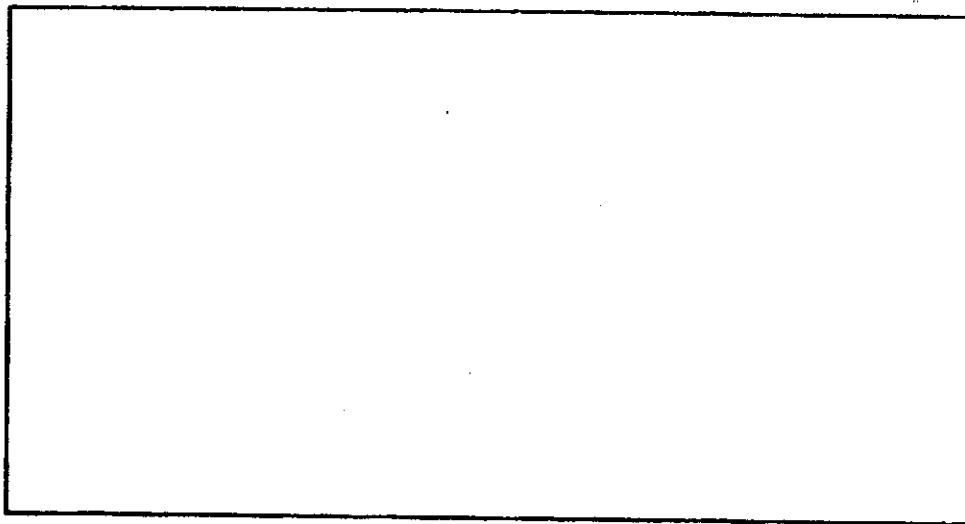

Question 36 continues on the next page.

(Go on to the next page)

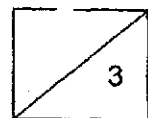

Question 36 continues on this page.

- (c) John wanted to add a new yellow bulb to the circuit without decreasing the brightness of the bulbs when the circuit is closed. Describe how John should connect the new bulb to the circuit.

[1]

(Go on to the next page)

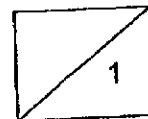

37. Mrs Ang poured some water into two identical pots and heated them on two different hotplates.

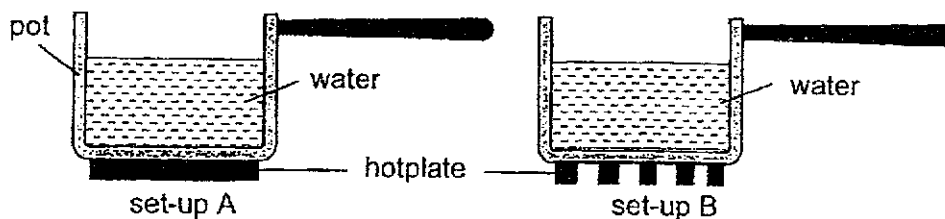

- (a) In which set-up, A or B, will the water boil first? Explain why. [2]

Mrs Ang poured the boiling water from set-up A into three identical beakers with an egg each.

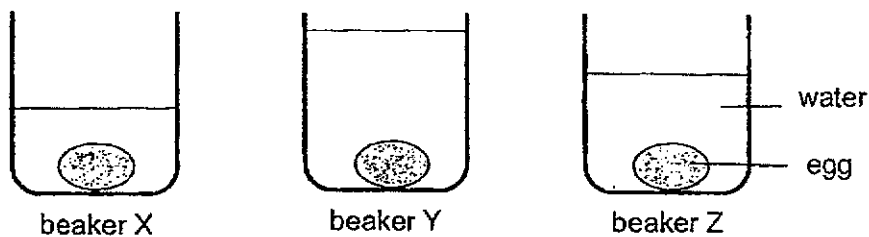

- (b) In which beaker, X, Y or Z, would the egg be cooked first? Give a reason for your answer. [1]

(Go on to the next page)

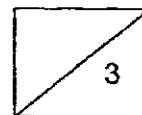

38. James bought a new water bottle that has a sprayer. On a hot day, he sprayed fine mist of water from the bottle on his face, as shown in the diagram below. His face felt cooler after that.



- (a) (i) Explain how spraying water on his face on a hot day helped James feel cooler. [1]

- (ii) Give a reason why James' face felt even cooler when the wind blows. [1]

- (b) As it was a really hot day, James decided to place his bottle of water in the refrigerator. He wanted to spray cold water on his face to cool himself down faster. Explain how cold water from the refrigerator is able to cool him down faster than water at room temperature. [1]

Question 38 continues on the next page.

(Go on to the next page)

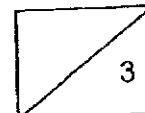

Question 38 continues on this page.

James left his water bottle on the table after spraying the cold water on his face. After a while, he saw water droplets on the outer surface of his water bottle below.

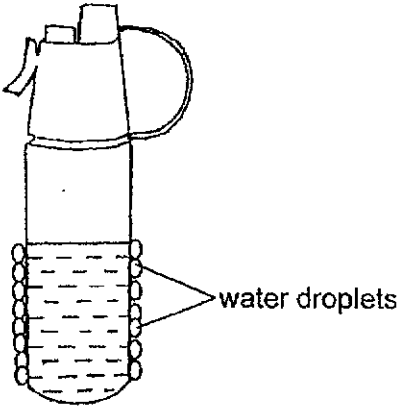

(c) Explain how the water droplets are formed.

[2]

(Go on to the next page)

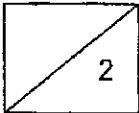

39. Paul conducted an investigation as shown below.

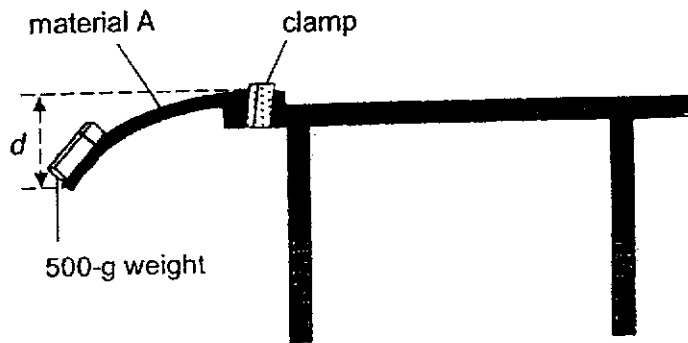

He clamped a strip of material A at the edge of the table before taping a 500-g weight to the end of the strip. As a result, material A bent as shown above. He measured the distance, d cm, to show how much material A has bent. Using the same 500-g weight, he repeated his investigation with materials B and C and recorded his results in the table.

Material	Distance d (cm)
A	5
B	0
C	13

(a) State the property of materials that Paul was investigating. [1]

(b) Based on the results of his investigation, which material, A, B or C, is the most suitable for making a food tray? Explain your answer. [1]

Question 39 continues on the next page.

(Go on to the next page)

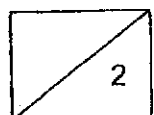

Question 39 continues on this page.

Paul conducted another investigation. He took two identical syringes and filled them with two different substances as shown below.

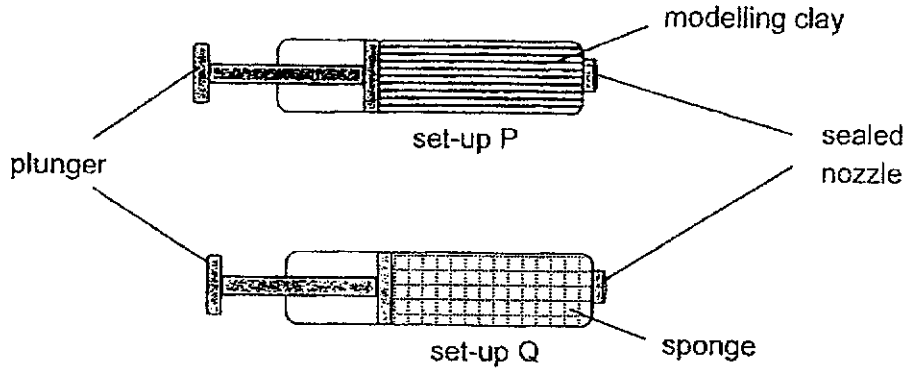

- (c) Paul observed that the plunger in set-up P could not be pushed in at all, while the plunger in set-up Q could be pushed inwards, but not all the way to the end. Explain this observation. [2]

(Go on to the next page)

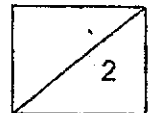

40. Gladys made an electromagnet as shown below.

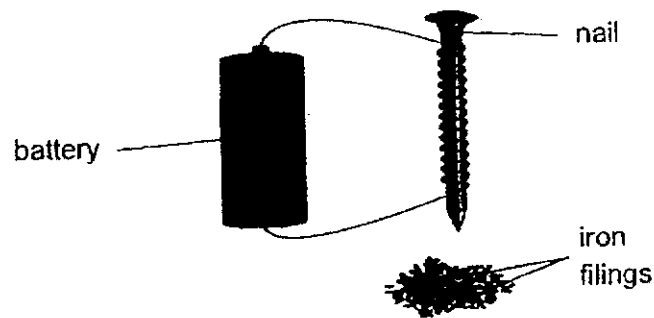

She used the electromagnet to attract some iron filings. The table below shows her results.

Number of turns of wire around the nail	Mass of iron filings (g)
10	2
20	4
30	7
40	10
50	15
60	15

(a) State the aim of her experiment. [1]

(b) Gladys noticed that the mass of iron filings attracted to the electromagnet remained the same in the last two readings. Give a reason why this is so. [1]

(Go on to the next page)

Question 40 continues on the next page.

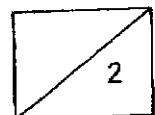

Question 40 continues on this page.

Gladys made a toy car using a bar magnet and some metal wheels. She pushed the toy car towards the left along a plastic track connected to an electrical circuit.

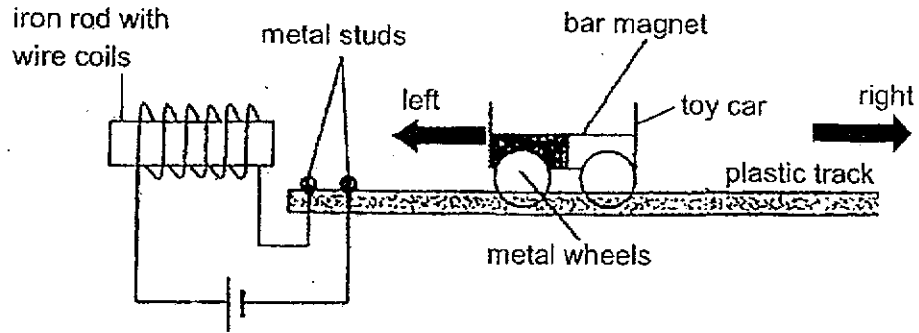

- (c) It was observed that when the toy car arrived at the metal studs, it would change its direction and move towards the right. Explain how this happened. [2]

~ End of Booklet B ~

Please check your work carefully

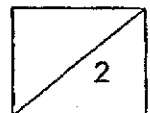

ANSWER KEY

YEAR : 2024
LEVEL : PRIMARY 5
SCHOOL : AI TONG
SUBJECT : SCIENCE
TERM : END OF YEAR

BOOKLET A

Q1	4	Q2	2	Q3	4	Q4	3	Q5	1
Q6	2	Q7	3	Q8	1	Q9	4	Q10	4
Q11	2	Q12	1	Q13	2	Q14	2	Q15	2
Q16	3	Q17	3	Q18	4	Q19	2	Q20	4
Q21	2	Q22	2	Q23	3	Q24	4	Q25	3
Q26	3	Q27	3	Q28	2				

BOOKLET B

Q29	<p>a) Meiyin changed the type of bread and the amount of water.</p> <p>b) Chioce : set up Q Data : There is water in Q Explain : so mould can grow</p> <p>c) No. Some fungi are edible / can be used to make bread.</p>
Q30	<p>a) The food made by the leaves above the cut-out section is not transported to the roots so the food is stored at the part above Y.</p> <p>b) It will grow bigger. Part Z is still able to get food made by the leaves below Y.</p> <p>c) The leaves above Y would wither as they could not get water to make food.</p>
Q31	<p>a) Seeds from fruit A is has wing-like structure unlike those from fruit B, so they can be carried by the wind.</p> <p>b) Plants disperse their seeds to prevent overcrowding of young plants.</p> <p>c) The fruit at the top of the tall tree is not blocked from the wind , so seeds can be carried further away by the wind.</p> <p>d) Rainwater will make the seed A heavier and unable to be dispersed further.</p>
Q32	<p>a) Carbon dioxide</p> <p>b) Rani needs more energy, so her heart needs to pump blood faster, to transport oxygen and digested food and remove carbon dioxide and waste materials faster.</p>
Q33	<p>a) The lungs take in oxygen from surrounding air on land, while the gills take in dissolved oxygen in the water.</p> <p>b) They both have a large exposed surface area of blood vessels.</p> <p>c) There is less dissolved oxygen in the water when temperature is highest. The fish flaps its gill cover the most for it to take in more dissolved oxygen from the water.</p>

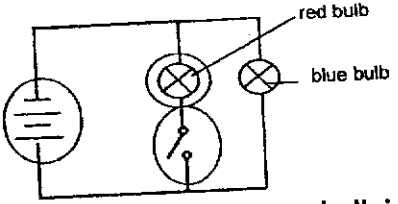
Q34	<p>a) Nucleus b) Cell Y. It does not have chloroplast that contain chlorophyll to trap sunlight to photosynthesis, so no oxygen is produced. c) When the amount of oxygen produced increases, it shows that the rate of photosynthesis has increased. d) Similar set-up but with the bell jar wrapped with opaque material.</p>
Q35	<p>a) Oxygen b) X could be number of tracing paper or distance between torchlight and leaf disc.</p>
Q36	<p>a) When the button was pressed, it formed a closed circuit and electricity can flow through to light the bulb.</p>  <p>b) c) John should add the new bulb in parallel to the bulbs.</p>
Q37	<p>a) Set - up A. The pot in set-up A has a larger surface area in contact with the hot plate. So, the water in the pot will gain heat faster and boil first. b) Beaker Y. It has the most amount of hot water at the same temperature/boiling water. It would have the most amount of heat energy, so the egg will cook first.</p>
Q38	<p>a) (i) Water droplets on his face gained heat from his face and evaporated (ii) The presence of wind speeds up the rate of evaporation of water. b) His face would lose more heat to the colder water from the refrigerator than the water at room temperature. c) The bottle lost heat to the cold water and formed a cold surface. Warmer water vapour from the surrounding air touches the colder outer surface of the water bottle, lost heat and condenses into water droplets.</p>
Q39	<p>a) Flexibility b) Choice : Material B Data : It bent the least when 500g weight was taped to it, so it is the least flexible material and is most suitable to make a food tray. c) Unlike Q, the plunger in set-up P could be pushed in as there is air spaces in the sponge which can be compressed. However, the plunger could not be pushed in all the way as the air and the spaces will still be occupying some space in the syringe.</p>
Q40	<p>a) To find out if the number of turns of wire around the nail affects the strength of the electromagnet. b) The electromagnet was not able to attract more iron filings as it has reached its maximum magnetic strength. c) A closed circuit is formed when metal wheels touch metal studs. The iron rod becomes an electromagnet and repels the toy car / bar magnet.</p>