

**PAYA LEBAR METHODIST GIRLS' SCHOOL (PRIMARY)**

**END-OF-YEAR EXAMINATION 2024**

**PRIMARY FIVE**

**SCIENCE**

**BOOKLET A**

**NAME** : \_\_\_\_\_ ( )

**CLASS** : P5 \_\_\_\_\_

**DATE** : 22 OCTOBER 2024

**TOTAL TIME FOR BOOKLETS A & B: 1 hour 45 minutes**

**INSTRUCTIONS TO PUPILS**

**DO NOT OPEN THIS BOOKLET UNTIL YOU ARE TOLD TO DO SO.**

**ANSWER ALL QUESTIONS.**

**Section A: Multiple Choice Questions (56 marks)**

For each question from 1 to 28, four options are given. One of them is the correct answer. Make your choice (1, 2, 3 or 4) and write your answer on the Answer Sheet.

1. Amphibians have \_\_\_\_\_ on their bodies.
  - (1) fur
  - (2) feathers
  - (3) moist skin
  - (4) dry scales
  
2. In which of the following processes does the characteristics of parents get passed on to their young?
  - (1) Pollination
  - (2) Fertilisation
  - (3) Germination
  - (4) Seed dispersal
  
3. The diagram shows the underside of a fern leaf.

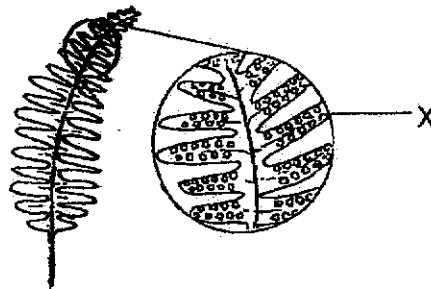

Based on the diagram, which of the following statements is most likely correct?

- (1) The fern has a weak stem.
- (2) X are seeds used for plant reproduction.
- (3) X contains spores used for plant reproduction.
- (4) The fern has its roots holding the plant firmly to the ground.

4. The diagram below shows the life cycle of an organism X.

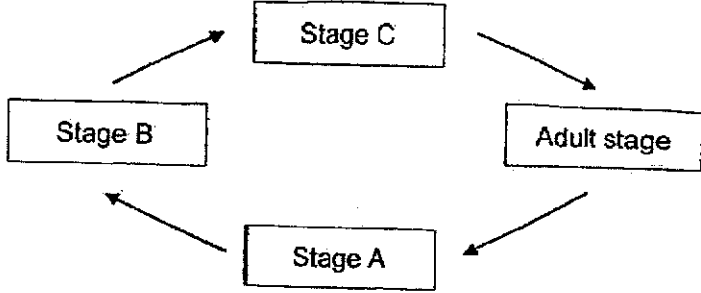

Which of the following correctly represents the amount of food that organism X consumes at the various stages of its life cycle?

(1)

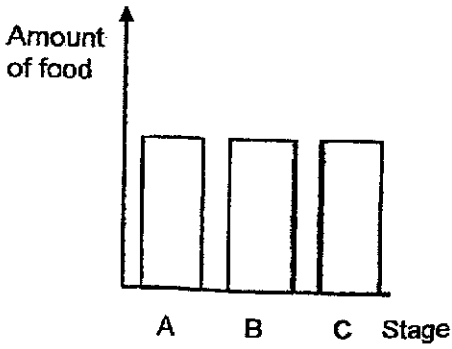

(2)

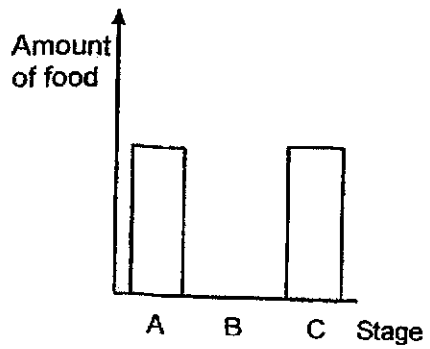

(3)

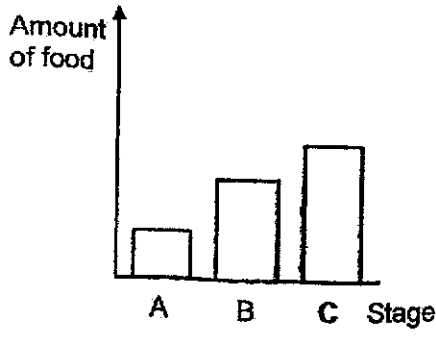

(4)

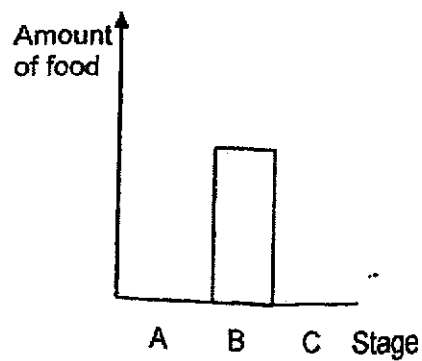

5. Dana placed the set-up below in a bright place.

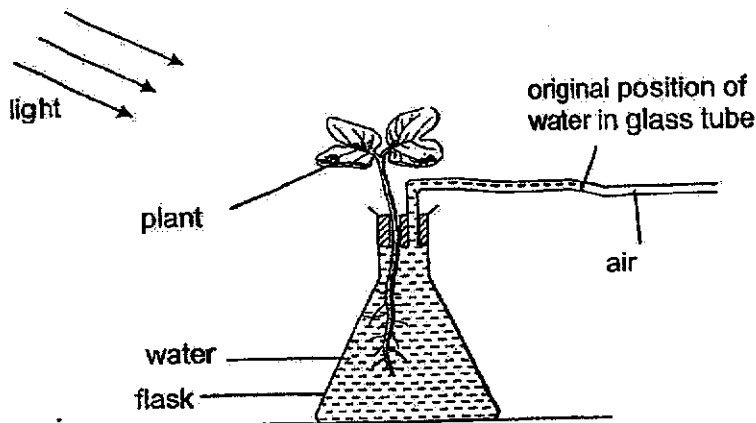

After some time, the water in the glass tube moved. Which direction did the water move and what was the reason for the movement?

	Direction in which the water in the glass tube moved	Reason
(1)	→	Oxygen is given out by the plant.
(2)	→	Water is given out by the plant.
(3)	←	Water is taken in by the plant.
(4)	←	Carbon dioxide is taken in by the plant.

6. The diagram below shows a plant cell with parts A, B, C and D labelled.

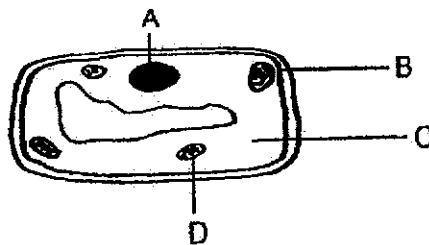

The part that is responsible for using light energy to make food is part \_\_\_\_\_.

- (1) A
- (2) B
- (3) C
- (4) D

7. Which of the following do plants need to carry out photosynthesis?

- A tiny openings on the leaves
- B chloroplasts
- C water-carrying tubes
- D food-carrying tubes

- (1) A and D only
- (2) B and C only
- (3) A, B and C only
- (4) A, B and D only

8. The diagram below shows how blood is transported in the human circulatory system.

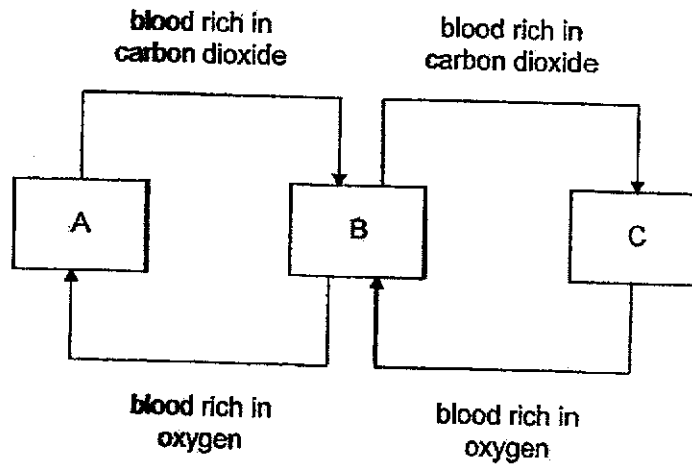

Which of the following parts of the body are represented by A, B and C?

	A	B	C
(1)	all parts of the body	lungs	heart
(2)	heart	all parts of the body	lungs
(3)	lungs	heart	all parts of the body
(4)	all parts of the body	heart	lungs

9. Germaine set up her experiment in a dark room as shown below.

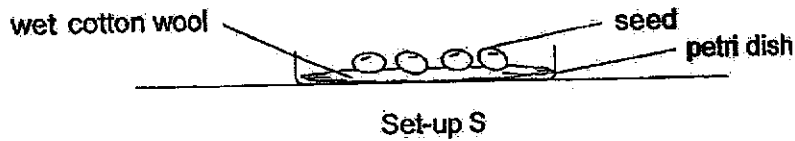

She prepared a similar set-up with dry cotton wool and placed it in the same dark room with set-up S.

What was the hypothesis tested in the experiment?

- (1) Seeds will only germinate if there is water.
  - (2) Seeds will not germinate when kept in the dark.
  - (3) Seeds will only germinate if there is warmth in the environment.
  - (4) Seed will not germinate when they are placed too close together.
10. A plant was placed inside a dark room with no windows.

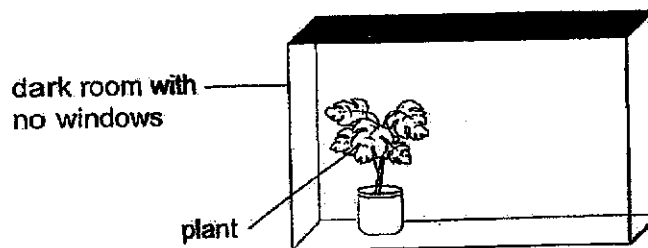

Which of the following shows the changes of the amount of gases in the room after 30 minutes?

	oxygen	carbon dioxide	water vapour
(1)	increased	increased	increased
(2)	increased	decreased	no change
(3)	decreased	decreased	no change
(4)	decreased	increased	increased

11. Maria wanted to find out whether the presence of water plants affect the amount of carbon dioxide in the pond. She used the set-up shown below.

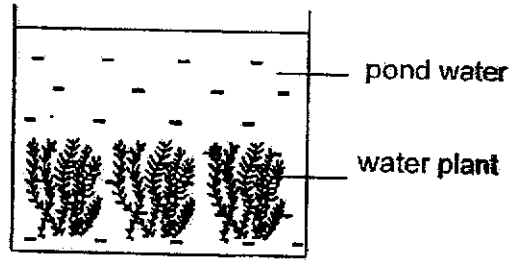

Which of the following set-ups should Maria use as a control for her experiment to show that the change in the carbon dioxide level is due to the presence of the water plants?

(1)

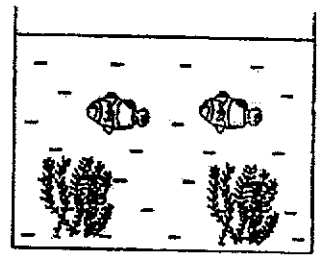

(2)

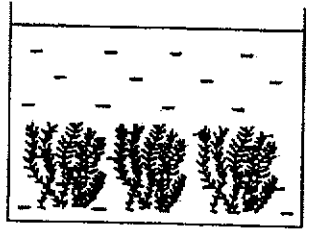

(3)

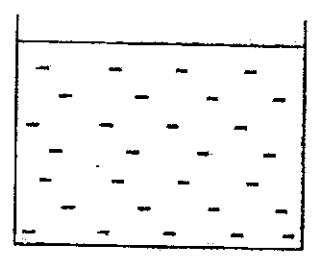

(4)

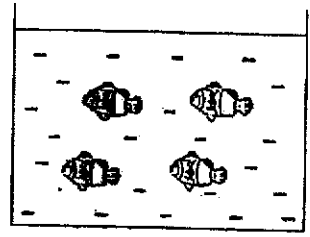

12. The diagram below shows the seeds of fruit M.

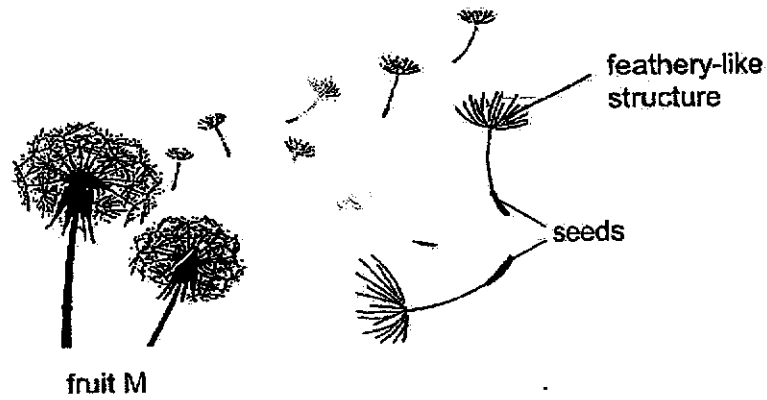

Which graph represents how the number of seeds dispersed changes with the wind speed?

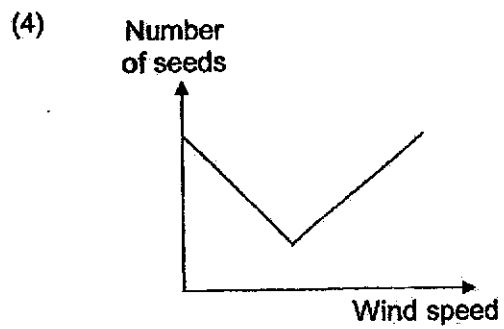
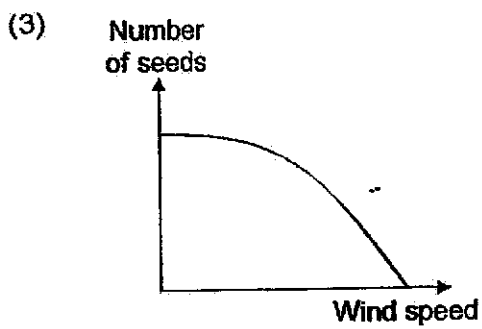
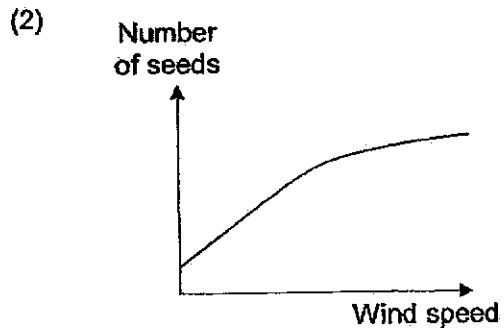
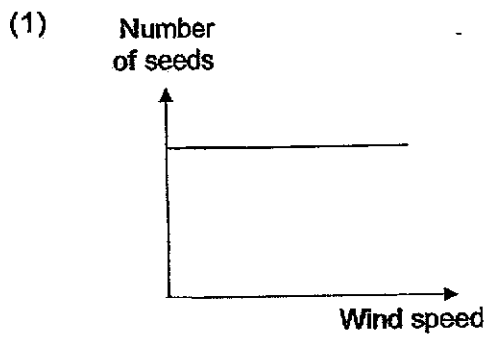

13. Which statement about ~~sexual~~ reproduction in ~~flowering~~ plants and ~~humans~~ is true?

- (1) ~~Fertilised eggs~~ are found in the ~~ovary~~.
- (2) Fertilisation occurs in a female reproductive part.
- (3) Only one ~~reproductive cell~~ is involved in fertilisation.
- (4) ~~The female reproductive cells~~ are ~~produced~~ in the anthers.

14. Alice wanted to find out if a ~~type of~~ plant growing in places with different amounts of carbon dioxide will have ~~different~~ number of tiny openings in their leaves.

She collected leaves from the ~~same~~ type of plant ~~growing in~~ different places and ~~counted the number of openings~~ as shown below.

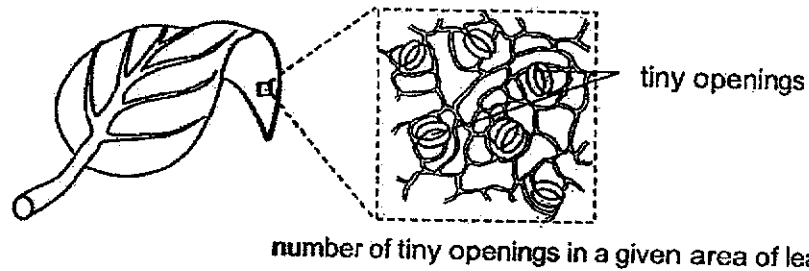

Which of the following variable(s) should Alice keep constant?

- A Size of plant
- B Amount of oxygen in the air
- C Number of tiny openings in a leaf
- D Amount of photosynthesis in each plant

- (1) A only
- (2) B and D only
- (3) A, B and C only
- (4) A, C and D only

15. Jiamin used four similar leaves, P, Q, R and S, of the same mass to conduct an experiment. These leaves have more tiny openings on their bottom surfaces than on their top surfaces. Leaves lose water through these tiny openings.

She coated some surfaces of the leaves with oil as shown in the table.

Leaf	Treatment
P	Oil on top and bottom surfaces
Q	Oil on top surface
R	Oil on bottom surface
S	No oil

After the leaves were left in the open area for an hour, she removed the oil and measured the mass of each leaf. Which shows the mass of the leaves in increasing order?

- (1) P, Q, R, S
- (2) P, R, Q, S
- (3) S, Q, R, P
- (4) S, R, Q, P

16. The diagram below shows an outdoor slide.

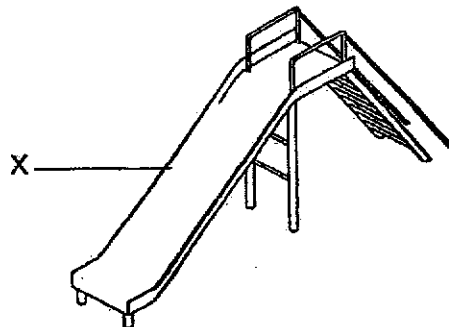

Metal is a suitable material for part X because it \_\_\_\_\_.

- (1) is strong
- (2) is flexible
- (3) can sink in water
- (4) does not allow light to pass through

17. Which statement about ~~steam~~ is ~~correct~~?

- (1) Steam is hot air.
- (2) Steam is water in the gaseous state.
- (3) Steam can be seen when water boils.
- (4) Steam is made up of tiny water droplets.

18. Jamal used the set-up below to conduct an experiment. A light sensor was used to measure the amount of light on the screen.

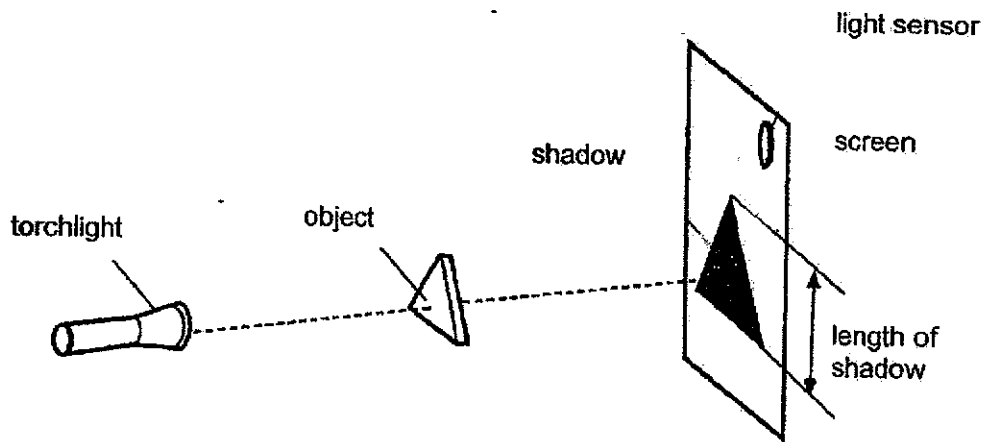

He changed the position of one of the items in the set-up and recorded his observations in the table below.

	Light sensor reading (units)	Length of shadow (cm)
At the start	110	7
At the end	280	17

What change did Jamal make?

- (1) The torchlight was moved away from the screen.
- (2) The screen was moved towards the torchlight.
- (3) The object was moved towards the torchlight.
- (4) The torchlight was moved towards the object.

19. The diagram below represents the Earth's water cycle.

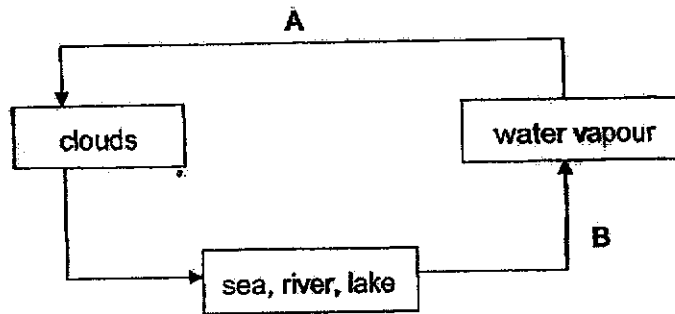

Which of the following correctly identify the heat transfer in processes A and B?

	A	B
(1)	heat gain	heat gain
(2)	heat loss	heat loss
(3)	heat gain	heat loss
(4)	heat loss	heat gain

20. Study the diagrams below.

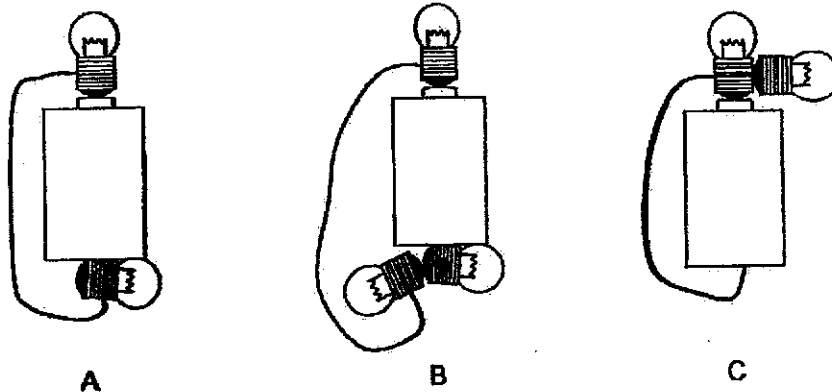

In which of the above circuit arrangement(s) will all the bulbs in the circuit light up?

- (1) A only
- (2) B only
- (3) A and C only
- (4) A, B and C

21. In the diagram below, when two of the bulbs fused, two other bulbs continued to light up.

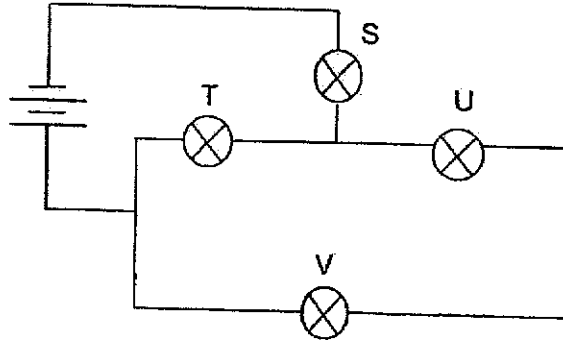

Which two bulbs were the ones that continued to light up?

- (1) S and T
- (2) T and U
- (3) U and V
- (4) S and V

22. Which apparatus can be used to measure 2 ml of water accurately?

(1)

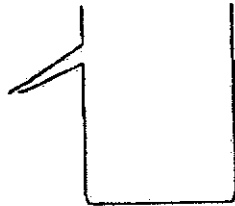

a displacement can

(2)

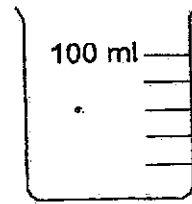

a beaker

(3)

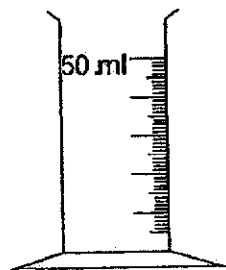

a measuring cylinder

(4)

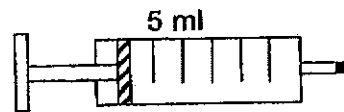

a syringe

23. The table below shows the melting and boiling points of three substances, E, F and G.

Substance	Melting point ( $^{\circ}\text{C}$ )	Boiling point ( $^{\circ}\text{C}$ )
E	19	102
F	-5	18
G	71	134

Which statement is correct about the substances if they are placed in a room at  $26^{\circ}\text{C}$ ?

- (1) Substance E will be in the solid state.
- (2) Substance G will be in the solid state.
- (3) Substances E and F will be in the liquid state.
- (4) Substances E and G will be in the gaseous state.

24. When water changes from liquid to solid at 0 °C, which of the following is correct?

- (1) The water is freezing.
- (2) The temperature of water is increasing.
- (3) There is no heat gain or loss by the water.
- (4) The water gains heat from the surroundings.

25. Amy filled three identical beakers, R, S and T, with the same amount of water but at different temperatures. The beakers were covered with a lid and left in a room with a temperature of 30 °C. The diagram below shows what happened to each beaker after some time.

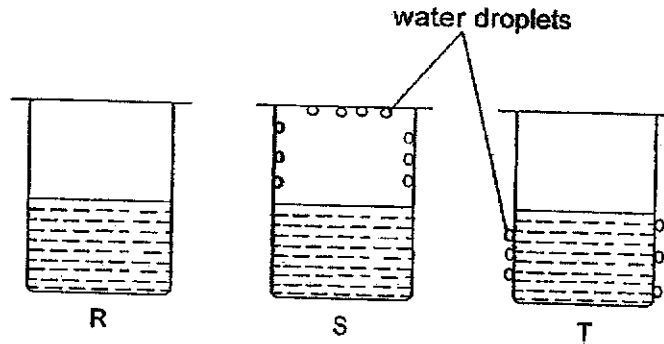

Which of the following correctly shows the temperature of the water in each beaker at the start of the experiment?

Temperature (°C)			
	R	S	T
(1)	5	95	30
(2)	30	5	95
(3)	30	95	5
(4)	95	30	5

26. Helen had a bar magnet. She placed a pin at each point, P, Q and R. She replaced each pin with a heavier pin, until she found the heaviest pin that could be attached without dropping.

The results are shown.

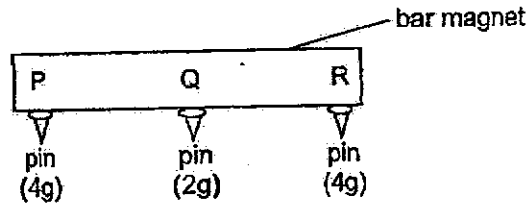

Which of the following can be concluded from the results?

- A P is the North pole.
  - B The pin is magnetic.
  - C The magnetic strength at Q is weaker than at R.
- (1) A and B only  
 (2) A and C only  
 (3) B and C only  
 (4) A, B and C

27. Study the three circuits as shown below.

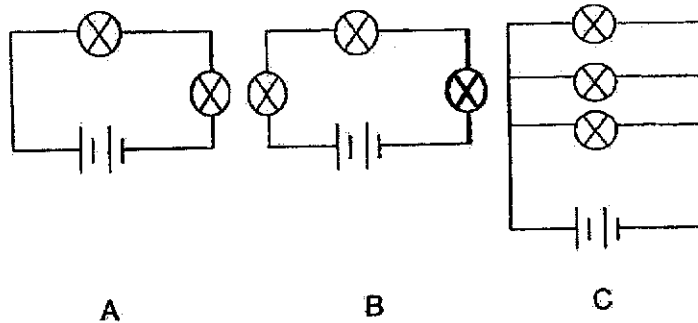

Arrange the brightness of each bulb in the circuit from the least bright to the brightest.

	Least bright	→	Brightest
(1)	B	A	C
(2)	C	B	A
(3)	B	C	A
(4)	C	A	B

28. Tammy connected 3 objects, A, B and C in a circuit as shown below. Bulbs 2, 3 and 4 lit up but bulb 1 did not. All bulbs and batteries are in working condition.

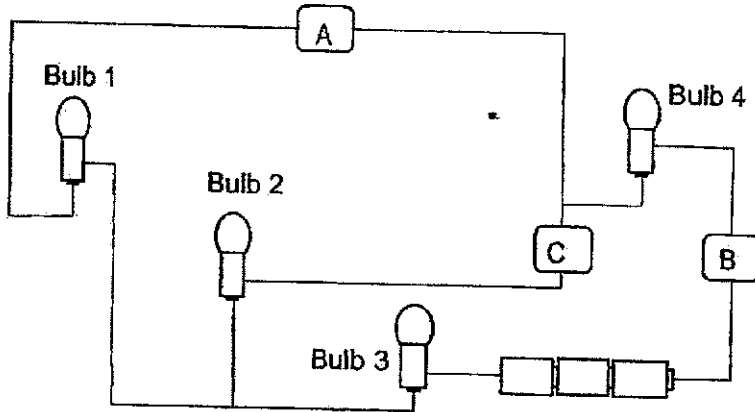

Which material(s) is/are electrical conductor(s) and electrical insulator(s)?

	Electrical conductors	Electrical insulators
(1)	A	B, C
(2)	B	A, C
(3)	A, B	C
(4)	B, C	A

END OF BOOKLET A



**PAYA LEBAR METHODIST GIRLS' SCHOOL (PRIMARY)**

**END-OF-YEAR EXAMINATION 2024**

**PRIMARY FIVE**

**SCIENCE**

**BOOKLET B**

**NAME :** \_\_\_\_\_ ( )

**CLASS :** P5 \_\_\_\_\_

**DATE :** 22 OCTOBER 2024

**TOTAL TIME FOR BOOKLETS A & B: 1 hour and 45 minutes**

<b>BOOKLET A</b>	<b>156</b>
<b>BOOKLET B</b>	<b>144</b>
<b>TOTAL</b>	<b>100</b>

**Parent's Signature:** \_\_\_\_\_

**INSTRUCTIONS TO PUPILS**

**DO NOT OPEN THIS BOOKLET UNTIL YOU ARE TOLD TO DO SO.**

**ANSWER ALL QUESTIONS.**

**SECTION B: 44 Marks**

For questions 29 to 40, write your answers in the spaces provided. The number of marks available is shown in brackets [ ] at the end of each question or part question.

29. The diagram shows how substances are transported in a plant. E and F represent different parts of the plant. The arrows represent the movement of substances G and H.

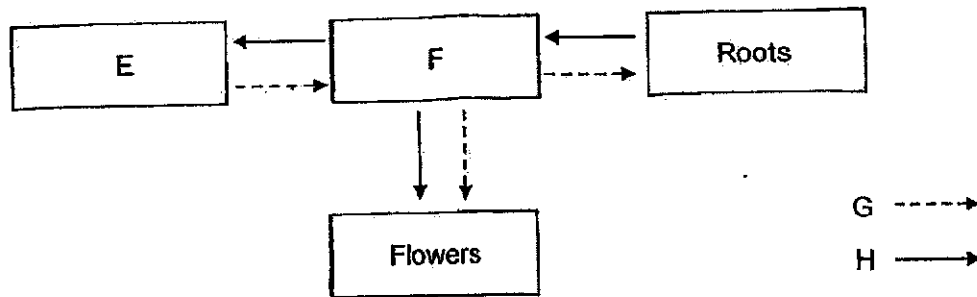

- (a) Identify parts E and F. [1]

E \_\_\_\_\_

F \_\_\_\_\_

- (b) Identify the substance represented by G and describe how the substance moves in the plant. [2]

\_\_\_\_\_

\_\_\_\_\_

3 / 3

30. The diagram below shows a single-celled organism which lives in a pond.

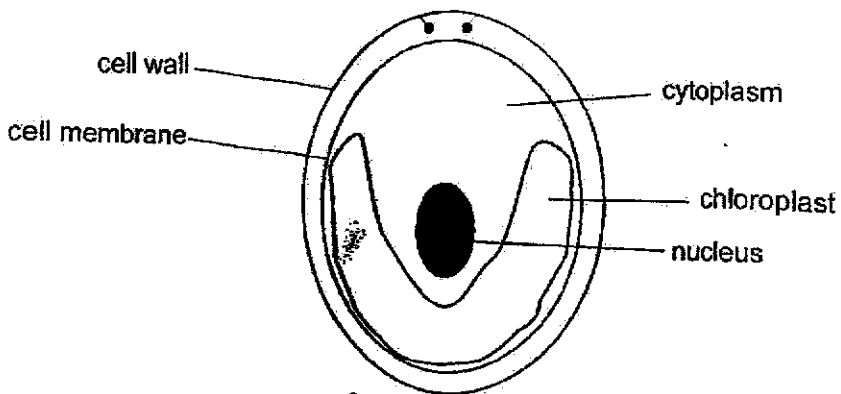

Use the information in the diagram to answer the following questions.

(a) State the function of the cell membrane. [1]

---

---

(b) Name two parts in the organism which show that it is more likely to be plant cell than an animal cell. [2]

---

---

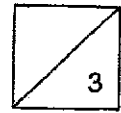

31. The diagram below shows the cross-section of an air sac present in the lungs.

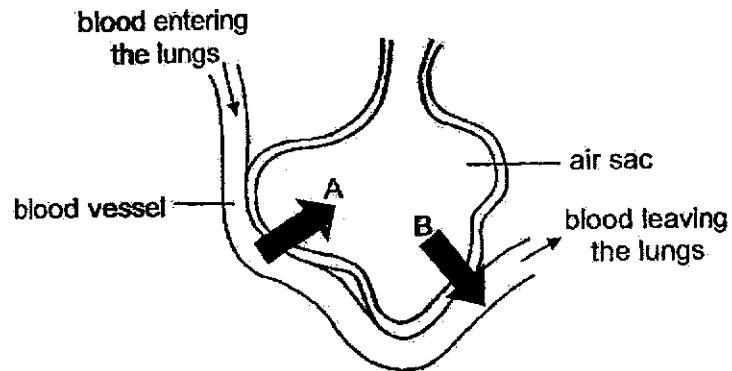

(a) Name gases A and B. [1]

A \_\_\_\_\_

B \_\_\_\_\_

(b) State the organ in a fish which has the same function as the lungs. [1]

\_\_\_\_\_

The diagrams below show an air sac in the lungs of a healthy person and in a person suffering from respiratory disease P.

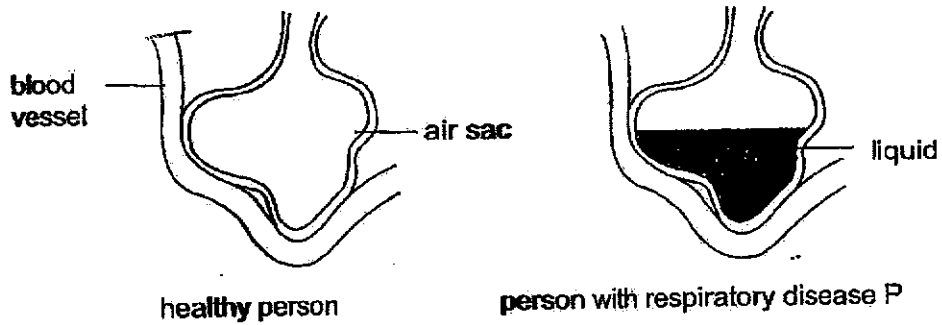

(c) Based on the information above, explain why a person suffering from respiratory disease P has a higher breathing rate than a healthy person. [2]

\_\_\_\_\_

\_\_\_\_\_

\_\_\_\_\_

32. The diagram below shows the cross-section of a flower from plant P.

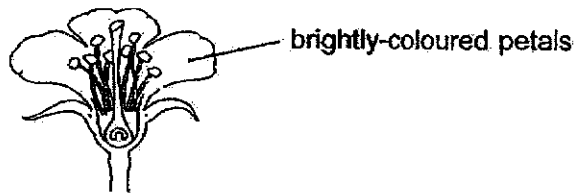

(a) Ella concluded that the flower is pollinated by insects. Explain why she said so. [1]

---



---

The diagram below shows how a fruit is formed from the flower of plant P.

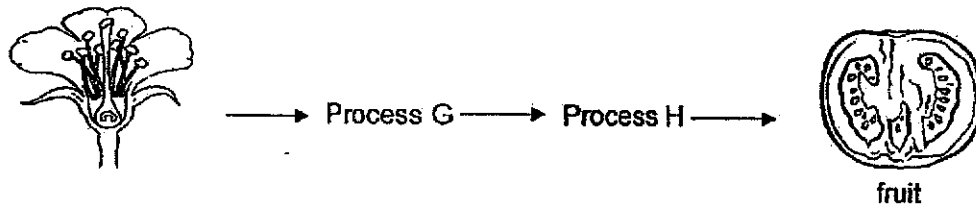

(b) Describe process G. [1]

---



---

Three similar flowers, L, M and N are obtained. Different part(s) of each flower are removed as shown in the diagram below.

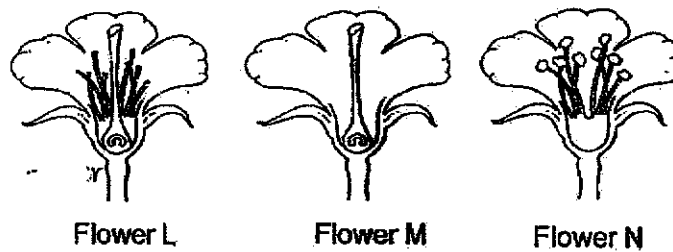

(c) Which of the flowers, L, M and N, can still develop into a fruit after pollen is dusted across all the flowers? Explain your answer. [2]

---



---

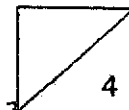

33. A scientist carried out an experiment to measure the volume of blood supplied per minute to different parts of the human body during two activities: resting and running.

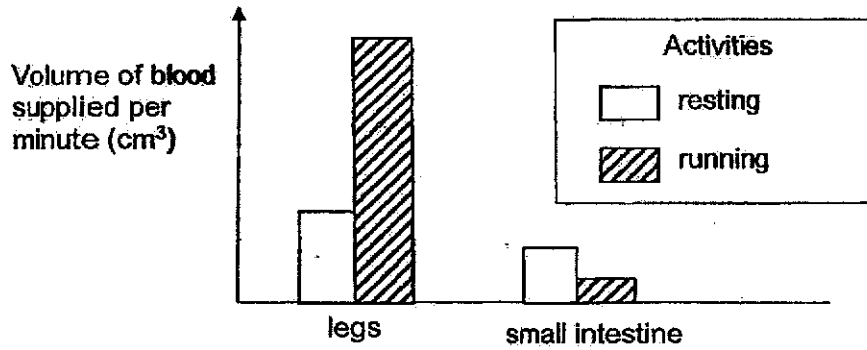

(a) Using the information given, explain how running after a meal affects the absorption of digested food in the small intestine? [2]

---



---



---

(b) Describe how oxygen in the air reaches the legs. [2]

---



---



---

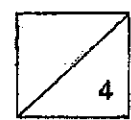

34. A diagram of the fruit of plant X is shown below. The seed coat surrounds the fleshy solid.

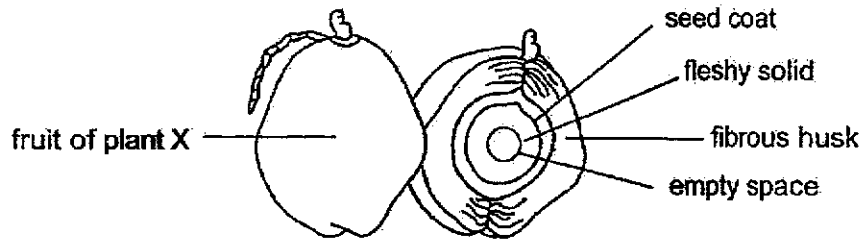

(a) Explain why seed dispersal is important. [1]

---

---

(b) Explain how the characteristic of the fruit of plant X helps in its dispersal. [1]

---

---

(c) The fleshy solid serves an important function in germination. Explain why this function is important before the true leaves develop. [1]

---

---

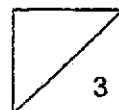

35. Helmi tied object Y on top of his plastic toy car. He then placed the car on a plastic track which allowed the car to travel in a straight line towards a wall. He attached a strong bar magnet on the wall.

Helmi moved the car with object Y towards the magnet. At a certain distance P, he released the car gently.

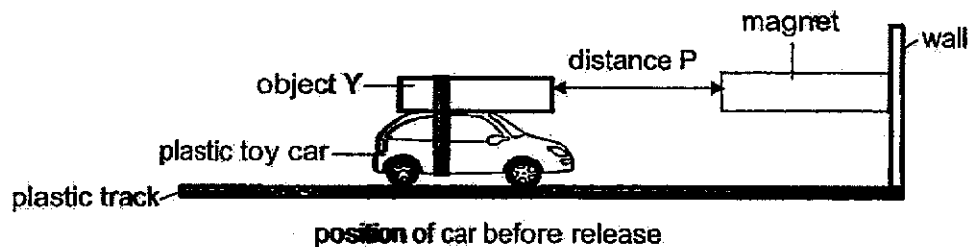

The car with object Y moved back and travelled a distance Q before stopping.

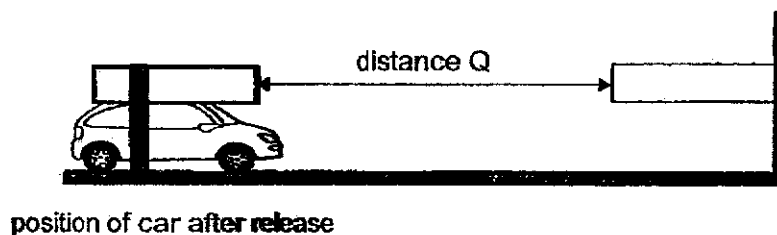

- (a) Based on his observation, state what object Y was. [1]

- (b) Explain why the car with object Y moved back when Helmi released it gently. [1]

- (c) Helmi replaced object Y with a wooden box of identical size and mass. He released the car at distance P gently. What will happen to distance Q when object Y is replaced with the wooden box? [1]

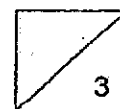

36. Linda put a metal spoon into a beaker filled with hot water in a room as shown in the diagram below.

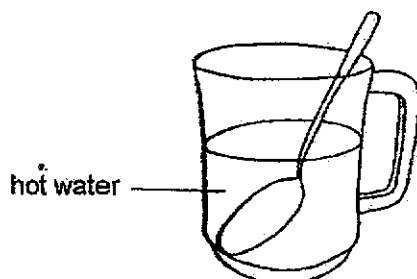

- (a) Explain why the metal spoon felt hot after a some time. [1]

Cally decided to prepare **hard** boiled eggs for her family. She placed three eggs of similar sizes each into three **identical** beakers, P, Q and R. She poured in different amount of hot water at **different** temperatures as shown.

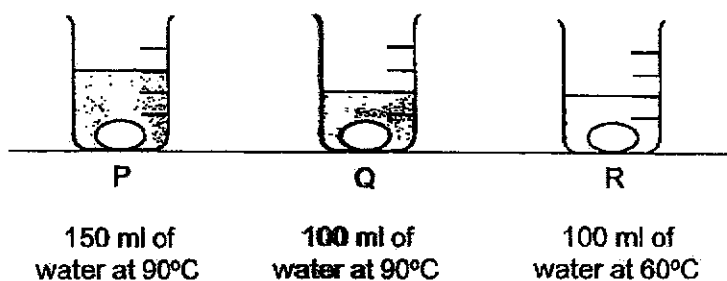

- (b) In which beaker will the **egg** be cooked the slowest after 10 minutes? Explain your answer. [2]

- (c) What can Cally do if she **wants** the eggs to cook even faster? [1]

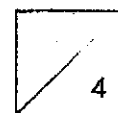

37. Zaki set up a circuit as shown in the diagram below.

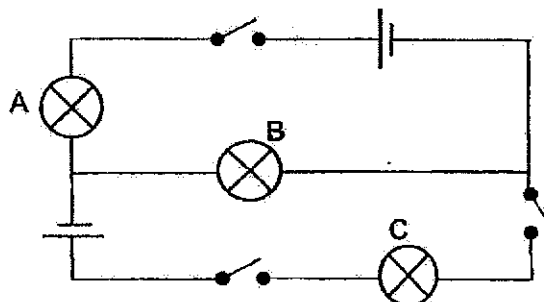

(a) Which two bulbs lighted up when only one of the switches was closed? [1]

Bulbs \_\_\_\_\_ and \_\_\_\_\_

Zaki constructed a model of how a carpark barrier gate works. When the switch is closed, the barrier arm moves up in direction D as shown.

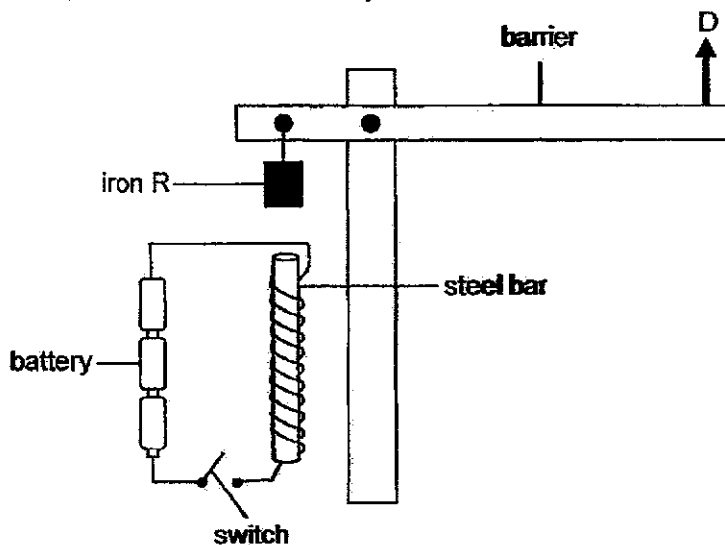

(b) Explain what caused the barrier to move up in direction D when the switch is closed. [2]

---



---



---

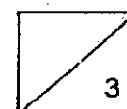

38. Caili sprayed some mist spray on her face.



- (a) State why Caili's face became dry very quickly. [1]

---



---

Caili sprayed the mist spray on her face again and stood in front of a moving fan.

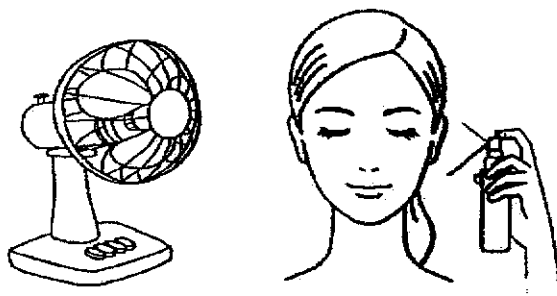

- (b) Explain why her face felt colder than before. [2]

---



---

- (c) State a difference between evaporation and condensation. [1]

---



---

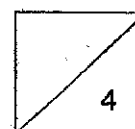

39. Eunice set up an electrical circuit as shown below. The bulb, wires and batteries are all in working condition.

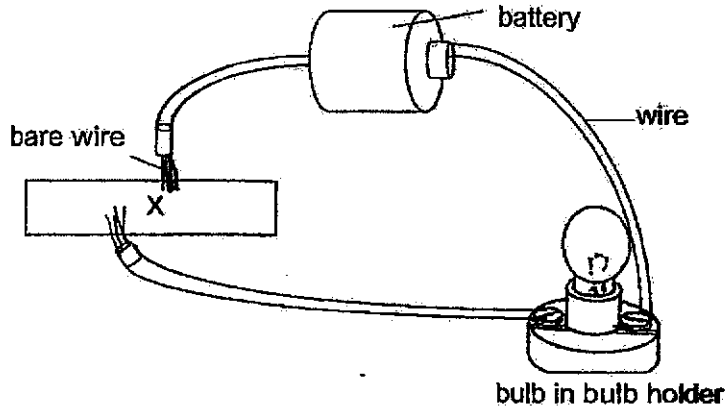

- (a) When Eunice placed X into the circuit, she observed that the bulb lit up. Give a reason for her observation. [1]

Eunice used **two** identical batteries, **two** bulbs and a **switch** to build her toy car. When the switch was closed, the bulbs lit up.

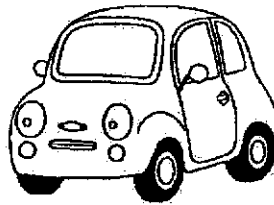

- (b) In the circuit below, draw wires that Eunice has to set up such that the two bulbs will light up with equal brightness. [2]

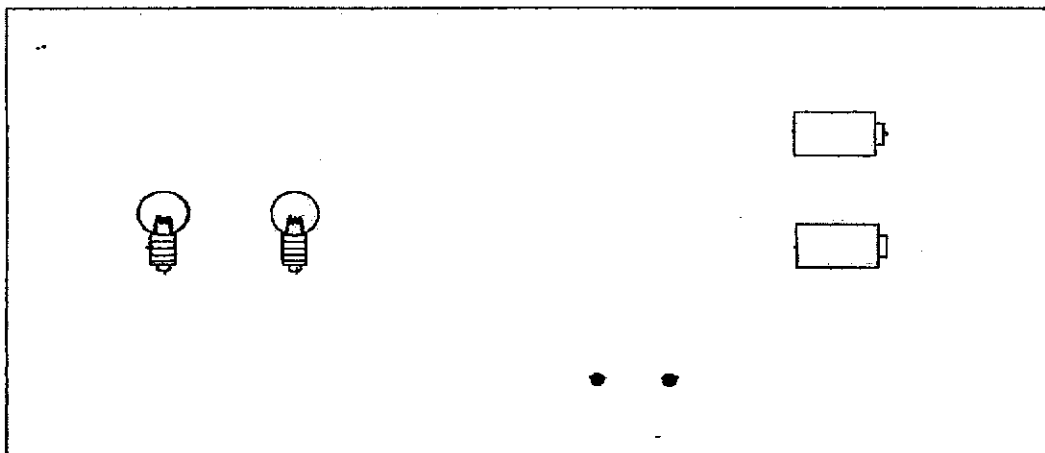

- (c) State an advantage and a disadvantage of setting up the light bulbs in the circuit that Eunice has set up. [2]

Advantage: \_\_\_\_\_

\_\_\_\_\_

Disadvantage: \_\_\_\_\_

\_\_\_\_\_

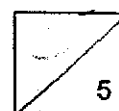

40. Vanessa placed two set-ups, A and B, in a room as shown below.

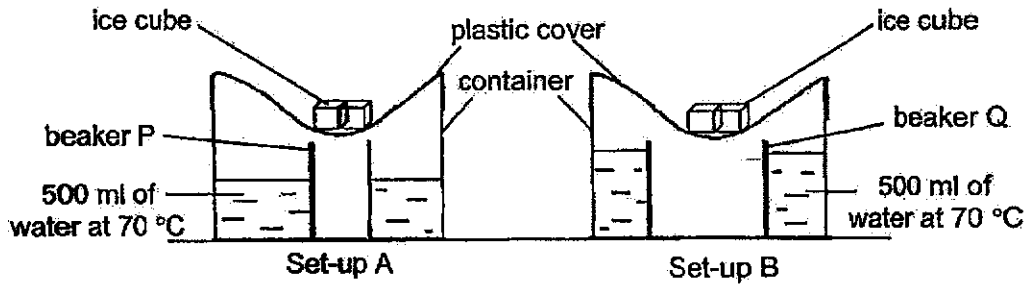

(a) After two hours, she observed that there was water collected in both beakers P and Q. Explain how the water was collected in both beakers P and Q. [2]

---



---



---

(b) Explain why there was more water collected in beaker P of set-up A. [2]

---



---



---

END OF BOOKLET B

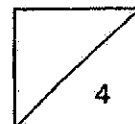

SCHOOL : PAYA LEBAR METHODIST GIRLS' PRIMARY  
 LEVEL : PRIMARY 5  
 SUBJECT : SCIENCE  
 TERM : SA2

## BOOKLET A

Q1	Q2	Q3	Q4	Q5	Q6	Q7	Q8	Q9	Q10
3	2	3	4	3	4	3	4	1	4
Q11	Q12	Q13	Q14	Q15	Q16	Q17	Q18	Q19	Q20
3	2	2	1	3	1	2	4	4	2
Q21	Q22	Q23	Q24	Q25	Q26	Q27	Q28		
1	4	2	1	3	3	1	4		

## BOOKLET B

Q29 (a)	E: leaves F: Stem
Q29 (b)	Food. Food made by the leaves are transported to all parts of the plant through the phloem.
Q30 (a)	It controls substances passing in and out of the cell.
Q30 (b)	The cell wall and chloroplast
Q31 (a)	A: Carbon dioxide B: Oxygen
Q31 (b)	Gills
Q31 (c)	When there is liquid in the air sac, it decreases the surface area for gaseous exchange. The person has to breathe faster to obtain oxygen needed by the body.
Q32 (a)	The flower has brightly-coloured petals to attract insects.
Q32 (b)	Process G is a process where pollen grains from a flower lands on the stigma of a flower of the same species.

Q33 (c)	L and M. They both still have <b>their</b> stigmas. M can still receive <b>pollen</b> grains from <b>the anther</b> of another flower. L still has its <b>anthers</b> , so <b>fertilisation can</b> take place for both flowers.
Q33 (a)	When running, more <b>blood is pumped</b> into the legs and less <b>blood is pumped</b> into the <b>small intestine</b> . Thus, the small intestine absorbs less <b>digested food</b> .
Q33 (b)	During <b>breathing</b> , oxygen <b>enters</b> the nose. In the lungs, oxygen is <b>absorbed</b> into the <b>circulatory system</b> . The heart pumps the <b>oxygen-rich blood to the lungs</b> .
Q34 (a)	To prevent <b>overcrowding and competition</b> amongst the parent plant and <b>other seedlings</b> .
Q34 (b)	The fruit of plant X has a <b>fibrous husk</b> that traps air to allow it to float on <b>water</b> , dispersing <b>its seeds</b> further away from the parent plant.
Q34 (c)	The <b>fleshy solid</b> are seed <b>leaves</b> which provide food for the seedling.
Q35 (a)	Object Y <b>was</b> a magnet.
Q35 (b)	Object Y was repelling the <b>magnet</b> as the like poles may be facing each <b>other</b> .
Q35 (c)	It will remain at the same <b>distance</b> at distance P.
Q36 (a)	The metal <b>spoon</b> gained <b>heat from</b> the hot water.
Q36 (b)	Beaker R. The temperature <b>of water</b> in beaker R is the lowest, hence heat transfer <b>will be</b> the slowest.
Q36 (c)	She can <b>put</b> the eggs over a <b>heat</b> source.
Q37 (a)	Bulbs A and B
Q37 (b)	When the <b>switch</b> is closed it <b>becomes</b> a closed circuit, electric currents can flow <b>through</b> the steel bar, causing it to be magnetised and become <b>an electromagnet</b> . Thus, it will attract iron R, causing the <b>barrier</b> to move up in direction D.
Q38 (a)	There was a large exposed <b>surface</b> area of the mist, resulting in an increase in the rate <b>of evaporation</b> of water. Thus,

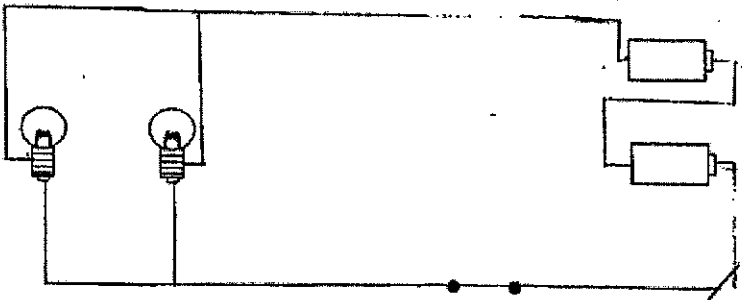
	causing the mist to dry very quickly.
Q38 (b)	Calli's face felt colder than <b>before</b> as wind from the moving fan increased the rate of <b>evaporation</b> of water. The mist gained heat and turned into <b>water vapour</b> .
Q38 (c)	The process of <b>evaporation</b> gains heat while the process of <b>condensation</b> loses heat.
Q39 (a)	X is a conductor of electricity.
Q39 (b)	
Q39 (c)	Advantage: When one bulb <b>fails</b> , the other bulb will still work. Disadvantage: The battery <b>will</b> run out faster.
Q40 (a)	The warm water vapour in the container touches the cooler surface of the plastic cover, the water vapour loses heat and condenses to form <b>water droplets</b> . The water droplets then dripped into the beakers below.
Q40 (b)	More water was collected in <b>beaker P</b> as there was a larger exposed surface area of <b>water</b> , so more water evaporated to become water vapour, <b>resulting</b> in more more more water vapour in the set-up to <b>condense</b> into more water droplets.

