



**CATHOLIC HIGH SCHOOL**  
**END-OF-YEAR EXAMINATION (2024)**  
**PRIMARY FIVE**  
**SCIENCE**  
**BOOKLET A**

Name: \_\_\_\_\_ ( )

Class: Primary 5 - \_\_\_\_\_

Date: 24 October 2024

28 questions

56 marks

Total Time for Booklets A and B: 1 hour 45 minutes

**INSTRUCTIONS TO CANDIDATES**

Do not turn over this page until you are told to do so.

Follow all instructions carefully.

Answer all questions.

Shade your answers in the Optical Answer Sheet (OAS) provided.

This booklet consists of 18 printed pages, excluding the cover page.

**Booklet A (28 × 2 marks)**

For each question from 1 to 28, four options are given. One of them is the correct answer. Make your choice (1, 2, 3 or 4). Shade your answer on the Optical Answer Sheet. (56 marks)

- 1 The table shows the characteristics of four things, A, B, C and D. A tick (✓) indicates the presence of the characteristic.

Thing	Needs air, food and water	Can make its own food	Can respond to changes	Has four legs
A				
B				
C				
D				

Which of the following correctly represents A, B, C and D?

	A	B	C	D
(1)	fly	rose plant	chair	zebra
(2)	zebra	chair	rose plant	fly
(3)	chair	fly	zebra	rose plant
(4)	zebra	chair	fly	rose plant

- 2 Dan made the following statements about an organism.

- It cannot make its own food.
- It cannot move from place to place.
- It produces spores for reproduction.
- It helps to break down dead organisms into simpler substances.

Which organisms are Dan describing?

- A bacteria  
 B mushroom  
 C bread mould  
 D bird's nest fern

- (1) A and C only  
 (2) B and C only  
 (3) A, B and D only  
 (4) B, C and D only

3 Study the diagram.

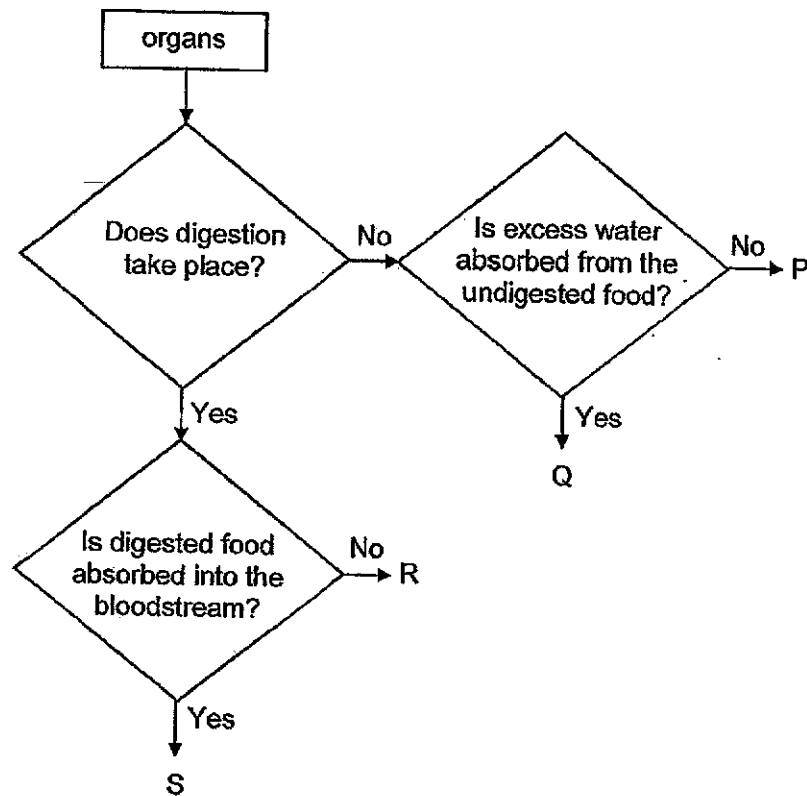

Which of the following best represents P, Q, R and S?

	P	Q	R	S
(1)	gullet	large intestine	mouth	small intestine
(2)	mouth	small intestine	gullet	stomach
(3)	mouth	small intestine	stomach	large intestine
(4)	stomach	large intestine	mouth	small intestine

4 Which plant part is matched correctly to its function?

	Plant part	Function
(1)	seed	to grow into a fruit
(2)	leaf	to grow towards sunlight
(3)	root	to hold the plant firmly to the ground
(4)	stem	to take in water and mineral salts from the soil

5 The diagram shows a plant.

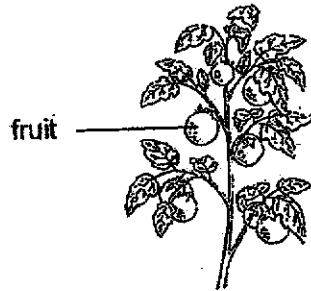

Which of the following correctly shows the stages in the life cycle of a plant?

(1)

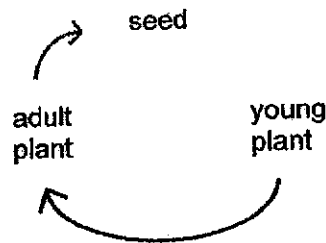

(2)

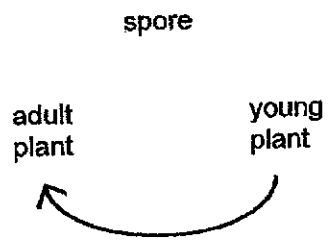

(3)

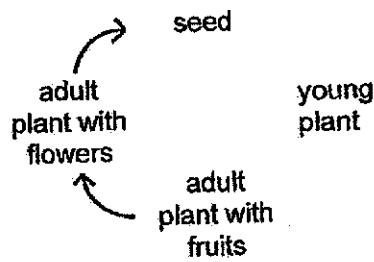

(4)

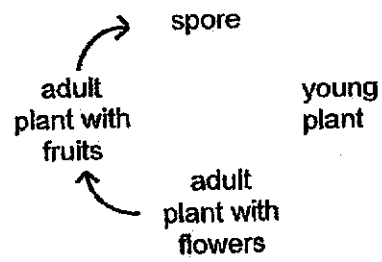

- 6 The diagram shows two flowers of the same kind.

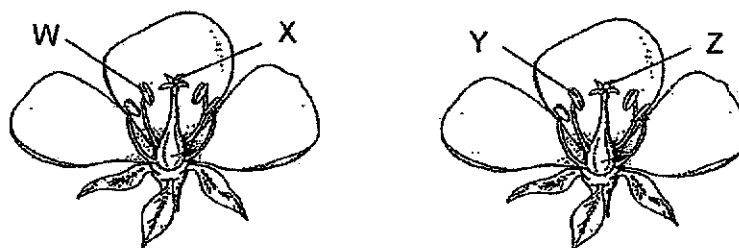

Pollination takes place when pollen grains are transferred from \_\_\_\_\_.

- (1) W to Y and W to X
  - (2) W to Z and Y to Z
  - (3) X to Y and X to W
  - (4) X to Z and Y to X
- 7 Junjie removed two parts from a flower as shown before pollinating it. After some time, the flower developed into a fruit.

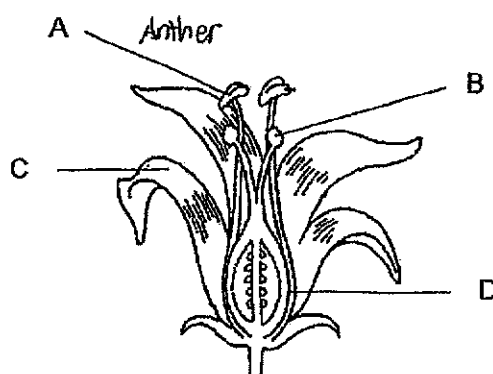

Which two parts of the flower did Junjie remove at the start?

- (1) A and B
- (2) A and C
- (3) B and D
- (4) C and D

8 Study the diagrams.

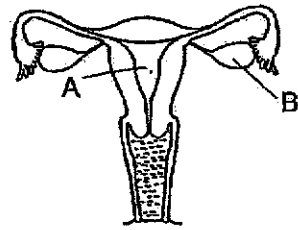

human reproductive system

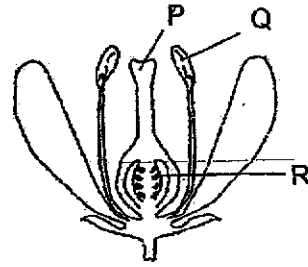

plant reproductive system

Which statement is correct?

- (1) Parts A and Q allow the egg to develop.
- (2) Parts B and Q contain male reproductive cells.
- (3) Parts B and R contain female reproductive cells.
- (4) Parts A and P are where fertilisation takes place.

9 The table shows some physical traits of the Chen family.

	Has dimples	Type of earlobes	Length of hair
Mr Chen	no	attached	short
Mrs Chen	yes	detached	long
Ben	yes	detached	short
Jenny	no	attached	long
Karl	no	detached	short

Based on the information, which statement(s) is/are correct?

- A Ben and Karl are twins.
- B Ben inherited more than two traits from Mrs Chen.
- C Karl is the only child who inherited Mr Chen's traits.
- D Jenny did not inherit any of the traits from Mrs Chen.

- (1) A only
- (2) D only
- (3) A and C only
- (4) B and D only

2

- 10 The diagram shows how water and food are transported in a plant.

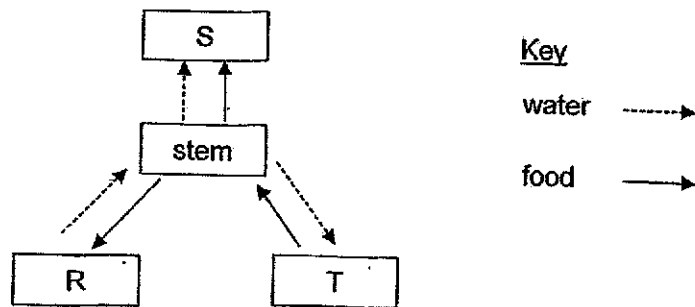

Which of the following correctly shows the parts of the plant?

	R	S	T
(1)	roots	flowers	leaves
(2)	roots	leaves	flowers
(3)	flowers	leaves	roots
(4)	flowers	roots	leaves

- 11 The following diagram shows the respiratory system of a fish.

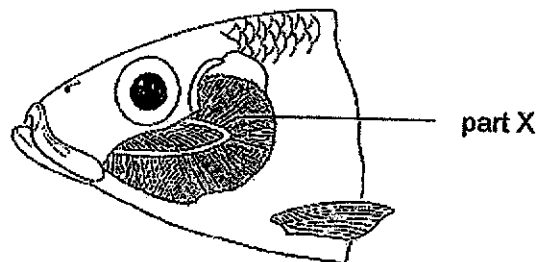

Which statement is correct about part X?

- (1) It allows water to be taken in.
- (2) It releases oxygen into the water.
- (3) It absorbs water containing carbon dioxide.
- (4) It has a rich supply of blood vessels for gaseous exchange.

12 Some people were trapped in a lift for thirty minutes. No fresh air entered the lift.

Which graph shows the correct change in the amount of gases at different time intervals?

Key

 oxygen

 carbon dioxide

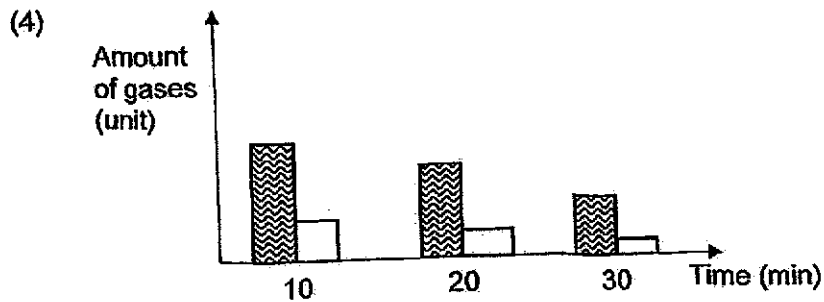
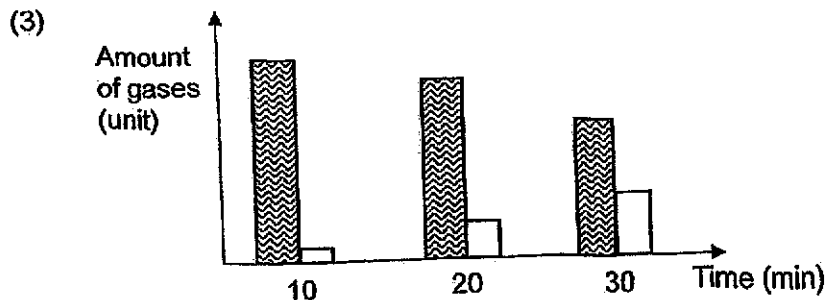
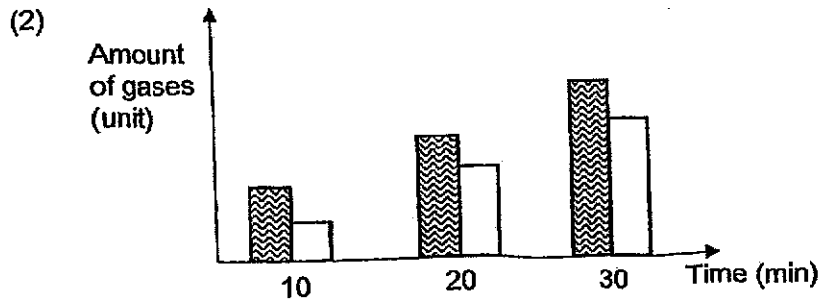
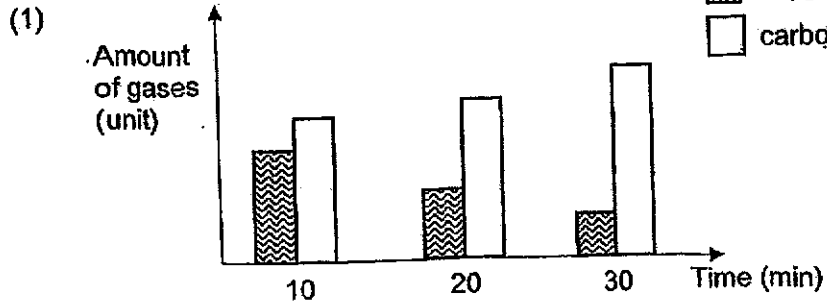

- 13 Which of the following correctly shows the basic unit of life for a dog and a sunflower plant?

	Dog	Sunflower plant
(1)	egg	seed
(2)	cell	cell
(3)	nucleus	nucleus
(4)	puppy	flower

- 14 The table shows the characteristics of three cells, X, Y and Z. A tick (✓) indicates the presence of the characteristic.

Parts of the cell	Cell X	Cell Y	Cell Z
cell wall			
nucleus			
chloroplast			
cell membrane			

Which of the following correctly identifies cells X, Y and Z?

	Cell X	Cell Y	Cell Z
(1)	cheek cell	root cell	leaf cell
(2)	leaf cell	cheek cell	root cell
(3)	root cell	leaf cell	cheek cell
(4)	root cell	cheek cell	leaf cell

- 15 The main source of energy that is passed on from one living thing to another comes from the \_\_\_\_\_.

- (1) Sun
- (2) nutrients
- (3) chlorophyll
- (4) carbon dioxide

- 16 Navi placed a wooden cover on a field as shown. After a month, she noticed that the grass patch under the cover turned yellow.

The grass patch turned yellow because there was not enough \_\_\_\_\_ for the grass.

- (1) water
  - (2) oxygen
  - (3) sunlight
  - (4) carbon dioxide
- 17 Study the set-up as shown. The potted plant is watered daily and placed under bright light for several hours.

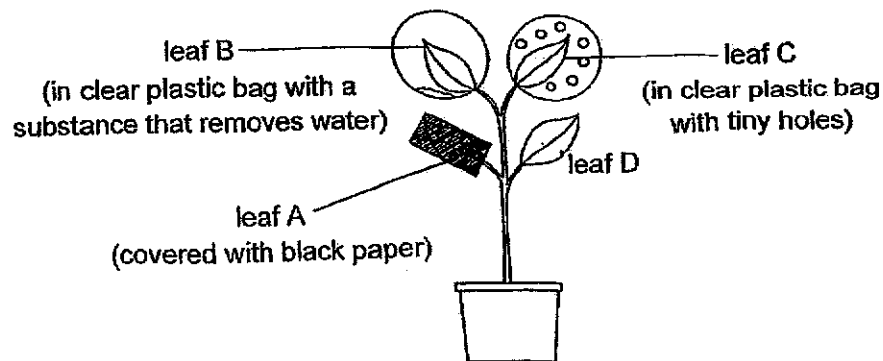

Which leaves will be able to produce oxygen?

- (1) A and B only
- (2) C and D only
- (3) A, B and C only
- (4) B, C and D only

- 18 Salehah carried out an experiment to find out if carbon dioxide is needed for photosynthesis. She used the set-up as shown.

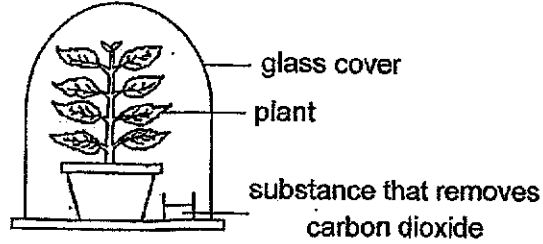

Which of the following should Salehah use as a control for her experiment?

(1)

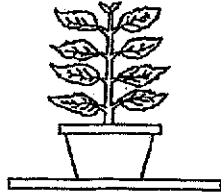

(2)

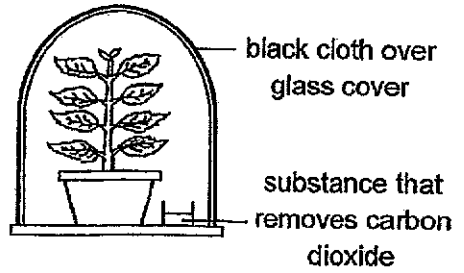

(3)

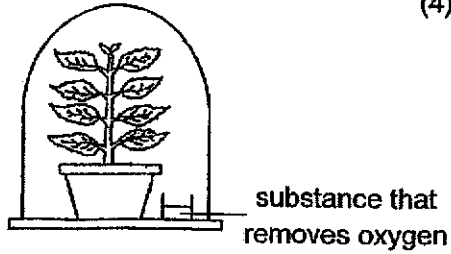

(4)

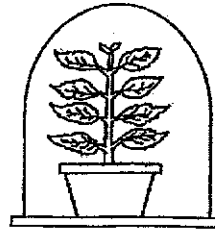

19 Tricia studied the effect of light on plant S. Her observations are as shown.

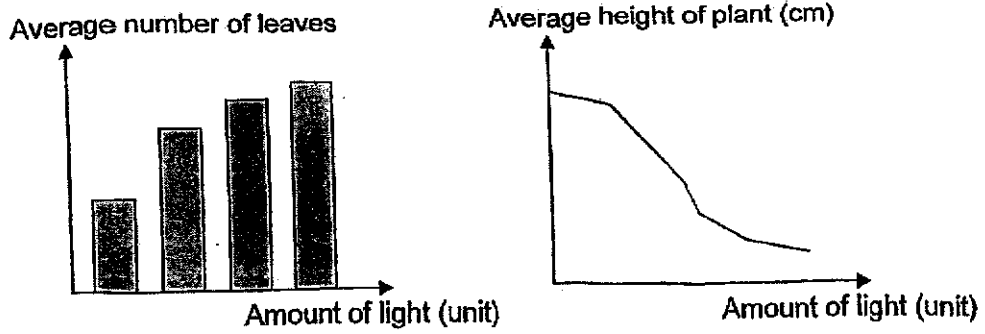

Which of the following would Tricia most likely observe when plant S was grown under different amounts of light?

(1)

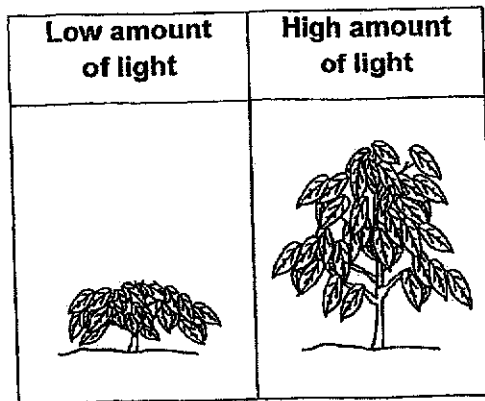

(2)

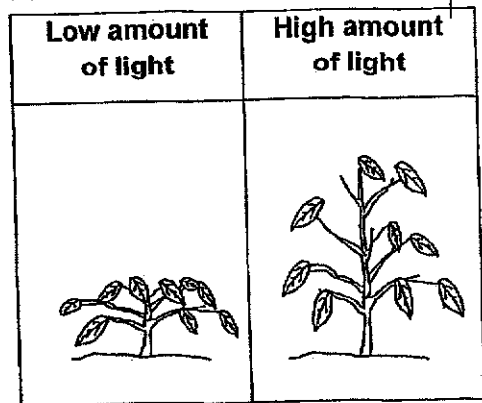

(3)

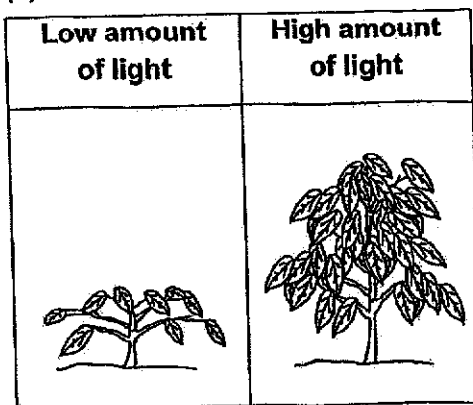

(4)

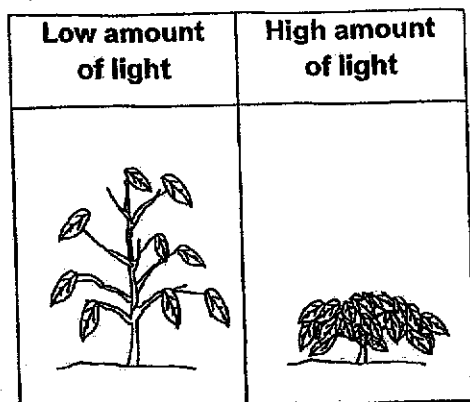

20 Four magnets are arranged as shown.

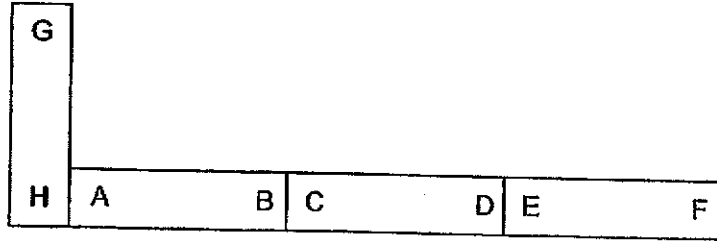

Which arrangement is possible?

(1)

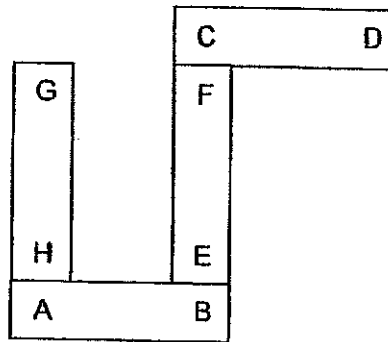

(2)

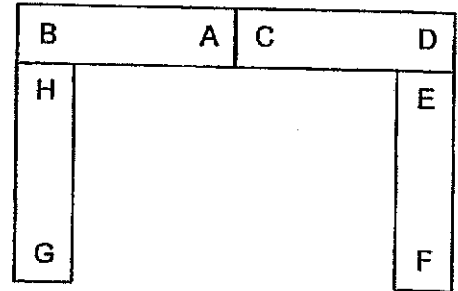

(3)

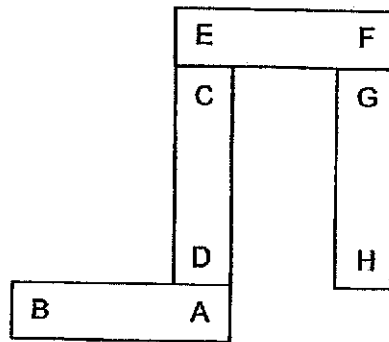

(4)

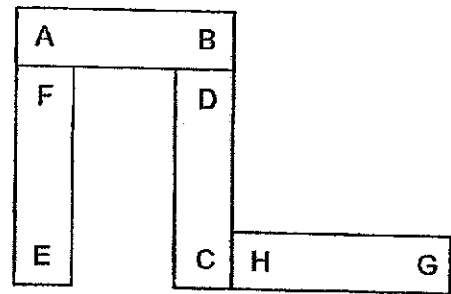

- 21 Aisha used the following set-ups to find out more about objects X and Y. First, she placed both objects on the balance.

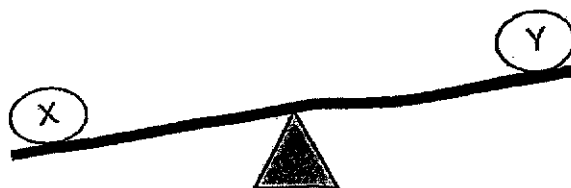

She then placed both objects into two similar beakers containing 150 ml of water as shown.

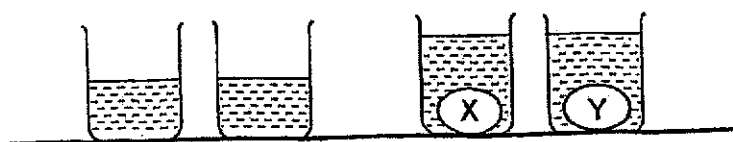



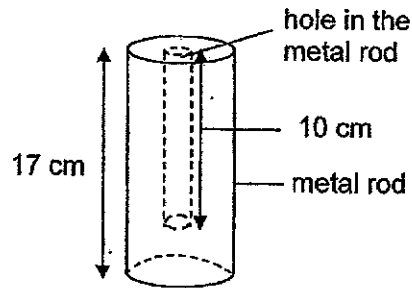

Based on the observations, what could Aisha conclude about objects X and Y?

- (1) Objects X and Y are not matter.
- (2) Objects X and Y have similar mass.
- (3) Objects X and Y have similar volumes.
- (4) Object X have a smaller mass than object Y.

22 Raju drilled a 10-cm hole into a 17-cm metal rod.



Which shadows can be cast by the metal rod?

- A 
- B 
- C 
- D 

- (1) A and B only
- (2) B and C only
- (3) A, B and D only
- (4) A, C and D only

- 23 Three similar glasses containing different amounts of hot tea at  $70\text{ }^{\circ}\text{C}$  were placed on a table.

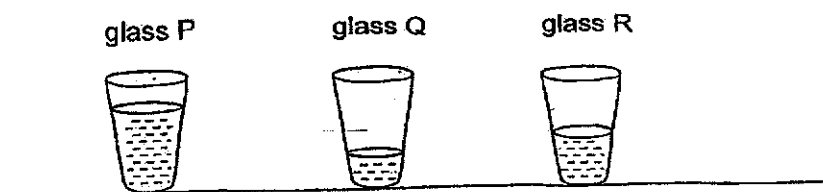

Which statement(s) is/are correct?

- A The hot tea in glass P had the most amount of heat energy.  
 B The hot tea in the three glasses had the same amount of heat energy.  
 C The hot tea in the three glasses would lose heat to the cooler surrounding air.
- (1) A only  
 (2) B only  
 (3) A and C only  
 (4) B and C only
- 24 The table shows the melting and boiling points of substances L, M and N.

Substance	Melting point ( $^{\circ}\text{C}$ )	Boiling point ( $^{\circ}\text{C}$ )
L	44	79
M	27	62
N	56	85

At which temperature will the three substances be in the same state?

- (1)  $33\text{ }^{\circ}\text{C}$   
 (2)  $60\text{ }^{\circ}\text{C}$   
 (3)  $72\text{ }^{\circ}\text{C}$   
 (4)  $80\text{ }^{\circ}\text{C}$

- 25 Xinyi used four set-ups, W, X, Y and Z, to find out how temperature affects the rate of evaporation of water.

Conditions at the start of experiment	W	X	Y	Z
volume of water (ml)	200	200	200	200
temperature of water ( $^{\circ}\text{C}$ )	50	70	50	70
temperature of surrounding ( $^{\circ}\text{C}$ )	26	21	26	26
speed of fan (unit)	2	2	3	3

Which two set-ups should Xinyi use to ensure a fair test?

- (1) W and X
  - (2) W and Z
  - (3) X and Y
  - (4) Y and Z
- 26 Tom set up a circuit as shown. All the batteries and the bulbs were in working condition.

He closed some switches.

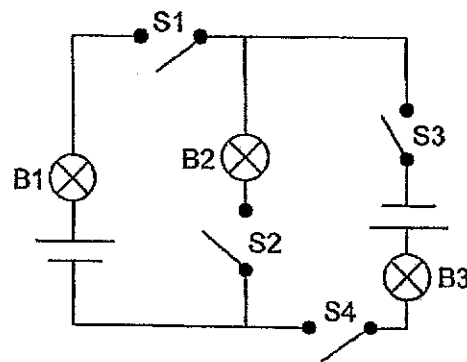

What is the minimum and maximum number of switches that should be closed so that only two bulbs will light up at the same time?

	Minimum	Maximum
(1)	one	three
(2)	two	four
(3)	two	three
(4)	three	four

- 27 A circuit is set up using identical batteries and bulbs in working condition.

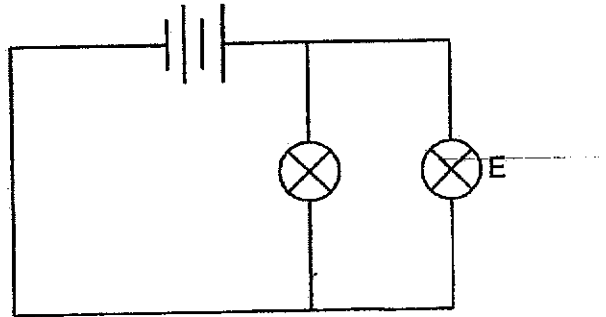

In which circuit will bulb F have the same brightness as bulb E?

(1)

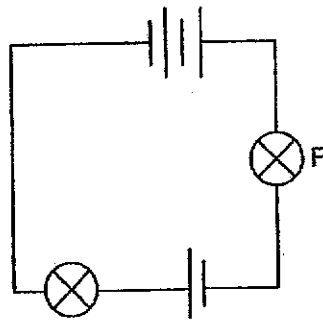

(2)

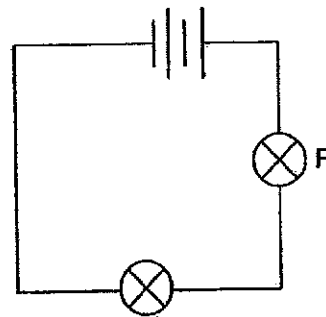

(3)

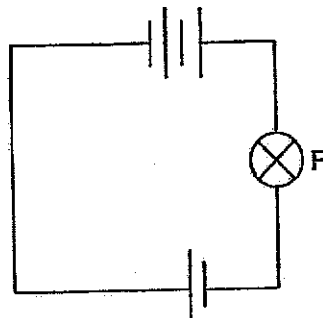

(4)

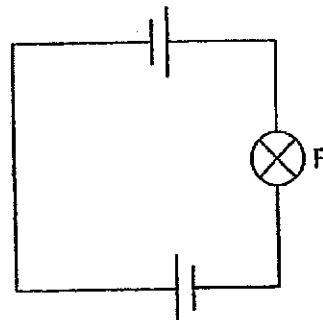

- 28 De Hong placed three rods, A, B and C, made of different materials, at positions, X, Y and Z, as shown in the circuit. All the batteries and the bulbs were in working condition.

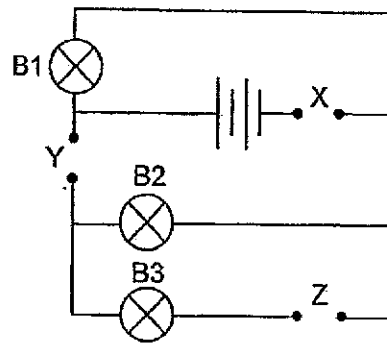

The results are as shown.

Position	X	Y	Z
Rod	A	B	C
Bulb	B1	B2	B3
Did the bulb light up?	yes	yes	no

He repeated the investigation by placing the rods at different positions as shown.

Position	X	Y	Z
Rod	B	C	A

Which of the following correctly shows what De Hong would observe?

	B1	B2	B3
(1)	lit	unlit	unlit
(2)	lit	lit	unlit
(3)	unlit	lit	unlit
(4)	unlit	lit	lit

End of Booklet A



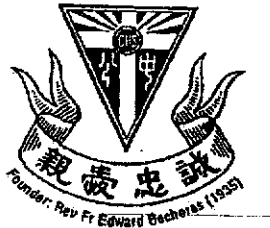

**CATHOLIC HIGH SCHOOL**  
**END-OF-YEAR EXAMINATION (2024)**  
**PRIMARY FIVE**  
**SCIENCE**  
**BOOKLET B**

Name: \_\_\_\_\_ ( )

Class: Primary 5 - \_\_\_\_\_

Date: 24 October 2024

Parent's Signature: \_\_\_\_\_

Booklet A	56
Booklet B	44
<b>Total</b>	<b>100</b>

12 questions

44 marks

Total Time for Booklets A and B: 1 hour 45 minutes

**INSTRUCTIONS TO CANDIDATES**

Do not turn over this page until you are told to do so.

Follow all instructions carefully.

Answer all questions.

Write your answers in this booklet.

This booklet consists of 15 printed pages, excluding the cover page.

**Booklet B (44 marks)**

For questions 29 to 40, write your answers in this booklet.  
 The number of marks available is shown in brackets [ ] at the end of each question or part question. (44 marks)

29 Study the diagram.

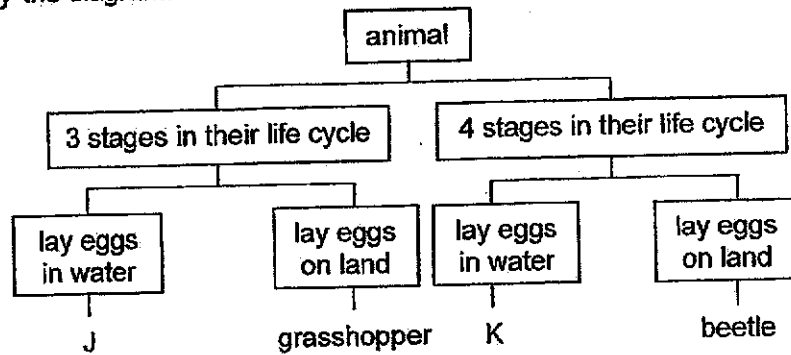

(a) Based on the diagram, state one similarity and one difference between animals J and K. [2]

(i) Similarity: \_\_\_\_\_

\_\_\_\_\_

(ii) Difference: \_\_\_\_\_

\_\_\_\_\_

The graph shows the mass of a butterfly at different stages of its life cycle.

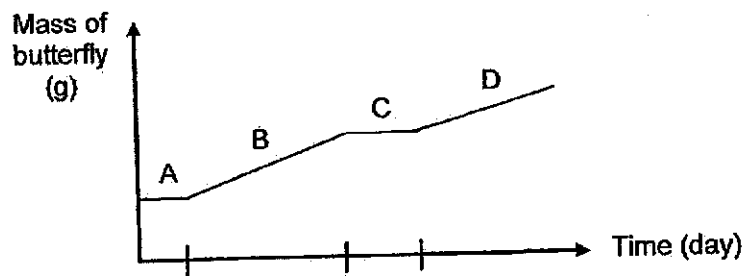

(b) Name stage C of the life cycle of the butterfly. Give a reason why there is no gain in mass during stage C. [1]

\_\_\_\_\_

(Go on to the next page)

SCORE	3
-------	---

30 Siti counted the number of two different types of young plants, S and T, at various distances from their parent plants. The results are as shown.

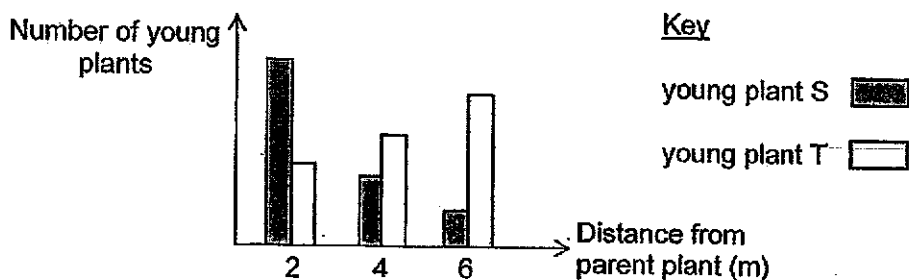

(a) State the relationship between the distance from the parent plant and the number of young plants for plant T. [1]

---



---

(b) Which of the following is most likely to be the fruit of plant T? Choose your answer and put a tick (✓) in the appropriate box. [1]







(c) Describe the method of dispersal in (b). [1]

---

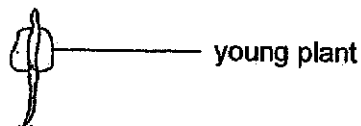

---

(d) The seed started growing into a young plant after dispersal.



State all the conditions needed for the above process to take place. [1]

---

(Go on to the next page)

SCORE	4
-------	---

31 The diagram shows one of the human body systems.

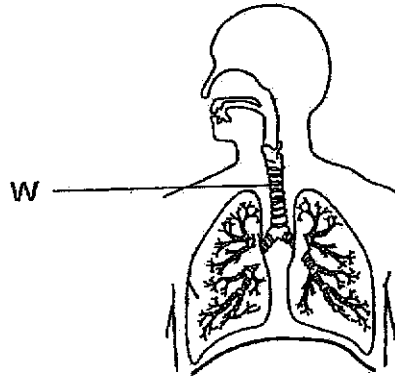

(a) Identify the system and name part W.

[1]

System: \_\_\_\_\_

Part W: \_\_\_\_\_

Joe is an athlete who uses a machine to track the amount of oxygen his body uses.

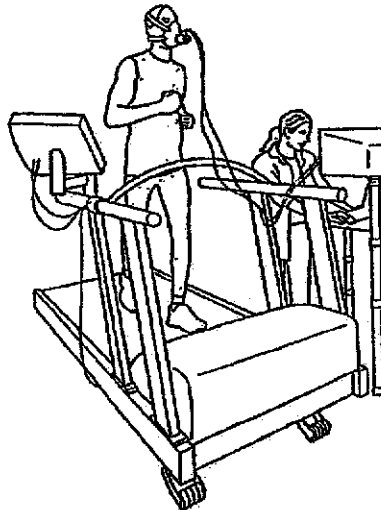

(Go on to the next page)

SCORE	/
	1

Continue from Question 31

The graph shows the amount of oxygen Joe takes in over a period of 20 minutes.

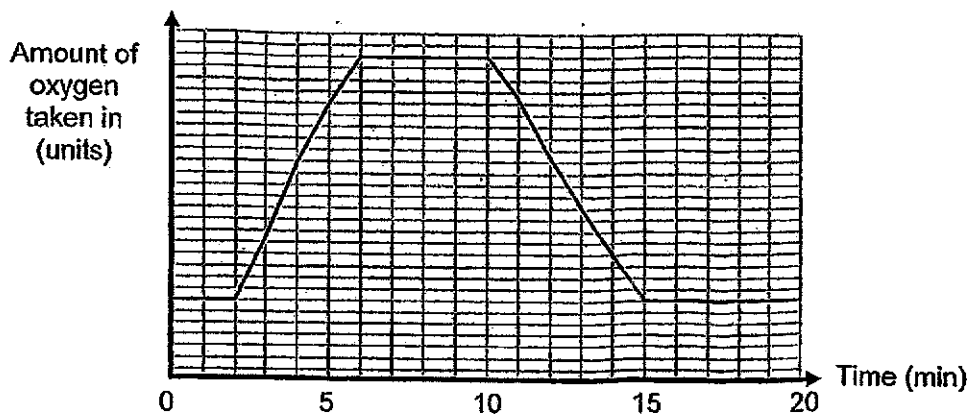

- (b) At which minute does Joe stop exercising? [1]

---

- (c) State what happens to the amount of oxygen taken in when he is exercising. Explain why. [2]

---



---



---

(Go on to the next page)

SCORE	3
-------	---

- 32 (a) Describe the process of photosynthesis in green plants. [1]

---



---

Lin wanted to find out how temperature affects the number of bubbles produced by a water plant by using the set-up as shown.

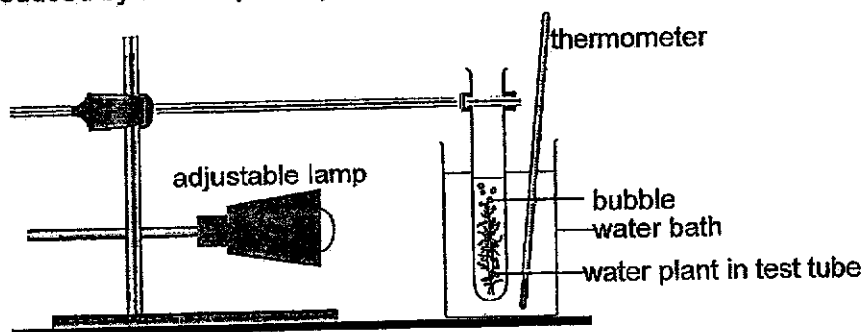

When the temperature of the water was 10 °C, the water plant did not produce any bubbles. She increased the temperature of the water in the water bath to 20 °C and the water plant started to produce bubbles. The temperature was increased to 30 °C and 40 °C subsequently.

The results are as shown.

Temperature (°C)	Number of bubbles produced in a minute
10	0
20	8
30	22
40	19
50	9

- (b) Based on Lin's results, state how temperature affected the rate of photosynthesis. [2]

---



---



---

(Go on to the next page)

SCORE	3
-------	---

*Continue from Question 32*

Lin also wanted to find out if the amount of light affects the number of bubbles produced.

- (c) Describe how Lin should carry out the experiment without changing any apparatus in the set-up. [2]

---

---

---

---

(Go on to the next page)

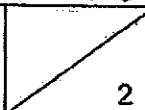
SCORE	
-------	---

- 33 Farmers often remove an outer ring from the branches with fruits on them. This method allows farmers to produce bigger fruits on these branches.

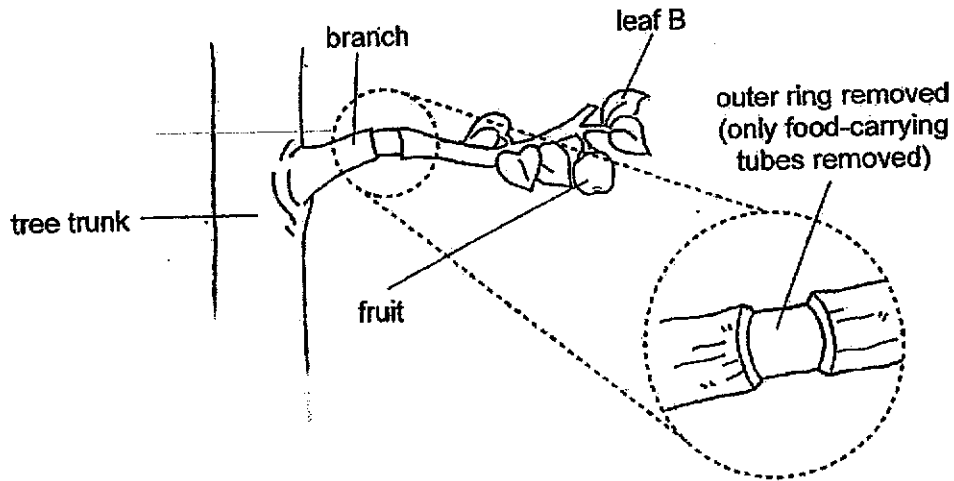

- (a) Give a reason why leaf B can still survive. [1]

---

---

- (b) Explain how this method helps to produce bigger fruits on the tree. [2]

---

---

---

(Go on to the next page)

SCORE	3
-------	---

- 34 Ahmad conducted an experiment by putting similar blocks of different masses onto three materials, A, B and C.

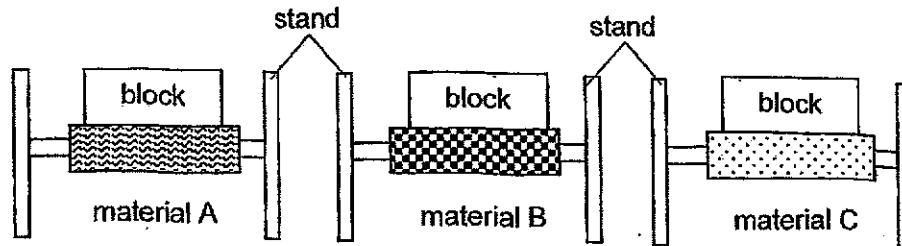

He recorded the mass that each material could hold before it broke.

Material	Mass of blocks the material could hold before it broke (g)
A	1000
B	2300
C	500

- (a) State the property that Ahmad was testing. [1]

---

- (b) Put a tick (✓) in the box(es) to indicate the changed variable. [1]

Variable	Changed
type of material	
mass of blocks	
thickness of material	

- (c) Based on Ahmad's results, which material, A, B or C, is most suitable to make a table? Explain why. [1]

---



---

(Go on to the next page)

SCORE	3
-------	---

35 Chitra wanted to make a magnet using the 'Stroke' method.

(a) Chitra knew that she needed a nail and a bar magnet. Name a suitable material for the nail. [1]

---

(b) Describe how Chitra could magnetise the nail using the bar magnet. [2]

---

---

---

After stroking the magnet on the nail, Chitra wanted to find out if it had really become a magnet.

She placed a magnet near the nail as shown. The nail was attracted to the magnet so she concluded that the nail had become a magnet.



(c) Her teacher told her that her conclusion might be wrong. Give a reason. [1]

---

---

(Go on to the next page)

SCORE	
-------	--

36 Study the diagram.

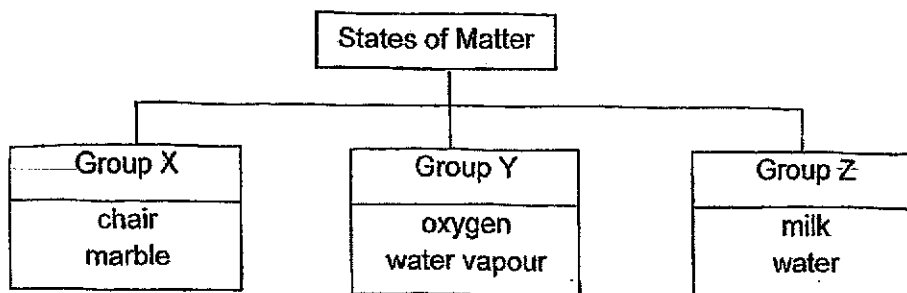

(a) Give a suitable heading for groups Y and Z. [1]

Group Y: \_\_\_\_\_

Group Z: \_\_\_\_\_

(b) State one difference in the property of matter in groups X and Y. [1]

\_\_\_\_\_

\_\_\_\_\_

Siva prepared two set-ups as shown. He poured 200 ml of water into each flask.

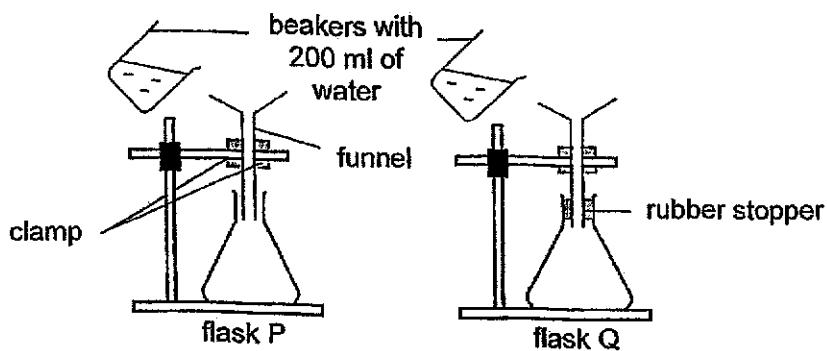

(c) Based on the diagram, which flask would collect lesser amount of water in three minutes? Explain why. [1]

\_\_\_\_\_

\_\_\_\_\_

(Go on to the next page)

SCORE	3
-------	---

37 Study the diagram.

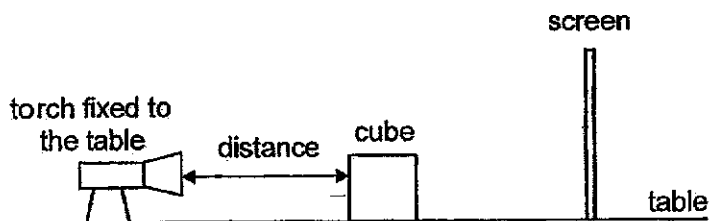

The results are as shown.

Distance between torch and cube (cm)	Length of shadow on the screen (cm)
10	21
15	16
20	11

- (a) Based on the results, state the relationship for the distance between the torch and cube and the length of the shadow. [1]

---



---

- (b) State how using the same cube helps to make the experiment a fair test. [1]

---



---

- (c) Without moving the screen, what can be done to make the shadow of the cube appear bigger? [1]

---



---

(Go on to the next page)

SCORE	3
-------	---

- 38 Zonglin conducted an experiment using two beakers, A and B, made of different materials, X and Y. Both beakers were filled with 200 cm<sup>3</sup> of water at 0 °C and heated over two similar bunsen burners.

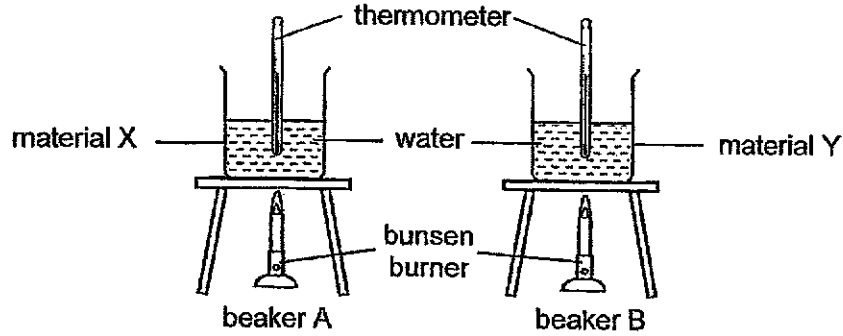

The temperature of water in beakers A and B were recorded every minute for some time. The results are as shown.

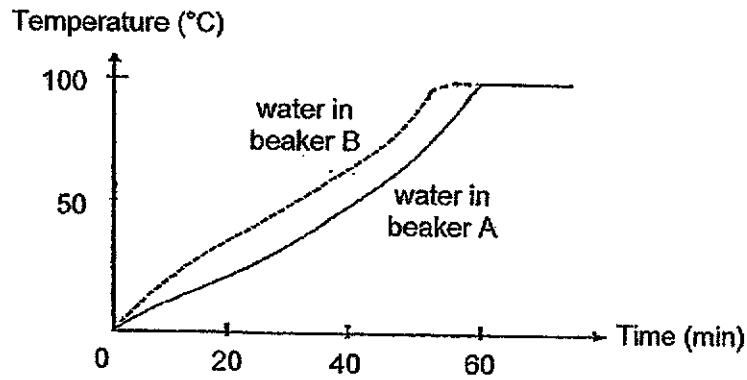

- (a) Based on the results, which material, X or Y, can be used to make a pot to cook soup in a shorter time? Explain why. [2]

---



---



---

- (b) State the temperature of the water in both beakers at the 65<sup>th</sup> minute. [1]

---

(Go on to the next page)

SCORE	3
-------	---

- 39 There is a glass door separating Huimin's kitchen and living room in the diagram. Huimin was in the living room with the air conditioner turned on at  $19\text{ }^{\circ}\text{C}$  while her mother was in the enclosed kitchen cooking dinner. The temperature in the kitchen was  $35\text{ }^{\circ}\text{C}$  and the glass door was completely closed.

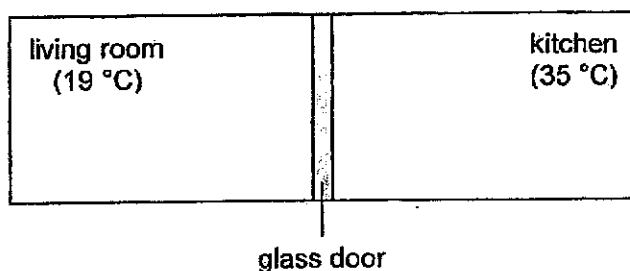

- (a) After 30 minutes, Huimin observed that there were water droplets on the glass door. In the diagram above, draw the water droplets on the correct side of the glass door. [1]
- (b) Explain your answer in (a). [2]

---



---



---

On another day, the temperature in the kitchen was  $26\text{ }^{\circ}\text{C}$ .

- (c) It was observed that there were less water droplets formed on the glass door. Explain why. [1]

---



---

(Go on to the next page)

SCORE	4
-------	---

Continue from Question 39

After dinner, Huimin's mother washed the dishes and placed them in two different ways as shown.



plates in a stack

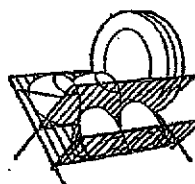

plates on a rack

- (d) State which way, placed in a stack or on a rack, would the plates dry faster. Explain why. [1]

---

---

(Go on to the next page)

SCORE	1
-------	---

40 Si-Ling studies the set-up of a simple flood-warning device as shown.

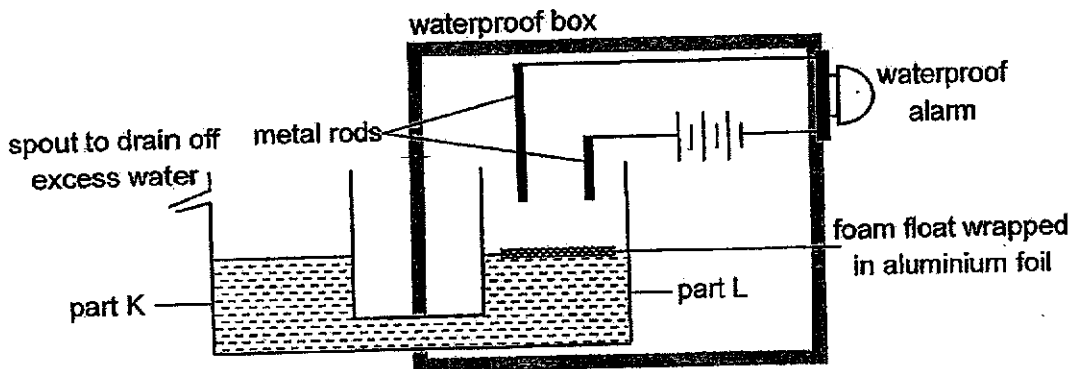

When it rains, water is collected in part K. When there is a long heavy downpour, the alarm will sound to alert of a possible flooding.

(a) Describe and explain how a long heavy downpour will cause the alarm to sound. [2]

---

---

---

---

(b) State a property of aluminium foil that allows the set-up to work properly. [1]

---

(c) Suggest a reason why most of the circuit is placed inside the waterproof box. [1]

---

---

End of Booklet B

SCORE	4
-------	---

SCHOOL : CATHOLIC HIGH PRIMARY SCHOOL  
LEVEL : PRIMARY 5  
SUBJECT : SCIENCE  
TERM : 2024 SA2

---

Q1	Q2	Q3	Q4	Q5	Q6	Q7	Q8	Q9	Q10
4	2	1	3	1	2	2	3	2	1
Q11	Q12	Q13	Q14	Q15	Q16	Q17	Q18	Q19	Q20
4	3	2	4	1	3	2	4	4	1
Q21	Q22	Q23	Q24	Q25	Q26	Q27	Q28		
3	1	3	2	4	3	4	1		

Name: \_\_\_\_\_ ( )

Date: \_\_\_\_\_

Class: 5 \_\_\_\_\_

P5 EYE Science Answer Key

No.	Answers	Marks	Remarks
29a	<p><i>Concept assessed: Compare between a three-stage life cycle and a four-stage life cycle.</i></p> <p>(i) Both <u>lay eggs in water</u>.</p> <p>(ii) Animal J has a <u>three-staged</u> life cycle but animal K has a <u>four-staged</u> life cycle.</p>	[1] [1]	comparison needed
b	<p><i>Concept assessed: Identify the stages in a four-stage life cycle.</i></p> <p><u>Pupa</u> stage.</p> <p>The <u>pupa does not eat</u>.</p>	[1]	
30a	<p><i>Concept assessed: State the relationship between two variables.</i></p> <p>As the distance from the parent plant <u>increases</u>, the number of young plants for plant T <u>decreases</u>.</p>	[1]	
b	<p><i>Concept assessed: Identify the characteristics of the fruit.</i></p> 	[1]	
c	<p><i>Concept assessed: Describe animal dispersal method.</i></p> <p>Fruit T has <u>hook-like structures</u> that <u>ding</u> onto the body covering of animals / human clothing.</p> <p>The fruit <u>is loosened</u> from the body as the animals <u>move around</u>.</p>	[1]	

d	<p><i>Concept assessed: State the conditions of germination.</i></p> <p>water, oxygen, warmth</p>	[1]	
31a	<p><i>Concept assessed: Identify the organs of the human respiratory and circulatory systems and describe their functions.</i></p> <p>System: respiratory system</p> <p>Part W: windpipe</p>	[1]	
b	<p><i>Concept assessed: Identify the organs of the human respiratory and circulatory systems and describe their functions.</i></p> <p>10th minute</p>	[1]	
c	<p><i>Concept assessed: Recognise that air is a mixture of gases such as nitrogen, carbon dioxide, oxygen and water vapour.</i></p> <p>The amount of oxygen taken in <u>increases</u>.</p> <p>He needs <u>more oxygen</u> to be <u>transported in the blood to all parts of the body</u></p> <p>_____</p> <p>_____</p> <p>to produce more energy.</p>	[2]	
32a	<p><i>Concept assessed: Describe the process of photosynthesis.</i></p> <p><u>carbon dioxide</u> _____ and <u>water</u> _____</p> <p>in the presence of <u>chlorophyll</u> and <u>sunlight</u> _____ is needed for photosynthesis to take place. <u>Food</u> _____ is produced and <u>oxygen</u> _____ is given out.</p> <p>_____</p>	[1]	

b	<p><i>Concept assessed: State the relationship between temperature and the rate of photosynthesis.</i></p> <p>As <u>temperature</u> increased from <u>10C to 30C</u>, the <u>rate of photosynthesis increases</u>.</p> <p>As <u>temperature</u> increased from <u>40C to 50C</u>, the <u>rate of photosynthesis decreased</u>.</p>	[2]	<p><i>Do not accept:</i></p> <ul style="list-style-type: none"> <li>- number of bubbles produced in a minute instead of rate of photosynthesis</li> </ul>
c	<p><i>Skills assessed: Describe the procedure to investigate the requirement (light energy) for photosynthesis.</i></p> <p><u>Changed variable</u></p> <p>Keep <u>the temperature of the water</u> in the water bath at <u>20C</u> and <u>change</u> the <u>brightness of the lamp</u>.</p> <p><u>Measured variable</u></p> <p>For each distance between the lamp and the water plant, <u>count the number of bubbles produced in a minute</u>.</p>	[2]	<p><i>Do not accept:</i></p> <ul style="list-style-type: none"> <li>- keep temperature of the water in the water bath at 10 °C</li> </ul>
33a	<p><i>Concept assessed: Identify the parts of the plant transport system and describe their functions.</i></p> <p>The <u>water-carrying</u> tubes can still transport water from the <u>roots</u> to <u>leaf B</u>.</p>	[1]	
b	<p><i>Skill assessed: Show objectivity by seeking data and information to validate observations and explanations about plant parts and functions.</i></p>		

	<p><b>Food</b> _____ made by the leaves will not be transported to the <b>roots</b> _____ as the food-carrying tubes are removed.</p> <p>OR</p> <p>Food made by the leaves will only be transported to the fruits on the branch as the food-carrying tubes are removed.</p> <p>AND</p> <p><b>More</b> _____ food was <b>stored in</b> _____ the <b>fruits</b> _____ on the branch.</p>	[2]									
34a	<p><i>Concept assessed: Comparison of materials on a property</i></p> <p>strength</p>	[1]									
b	<p><i>Skill assessed: To identify the changed variable in an experiment</i></p> <table border="1"> <thead> <tr> <th>variables</th> <th>changed</th> </tr> </thead> <tbody> <tr> <td>type of material</td> <td></td> </tr> <tr> <td>mass of blocks</td> <td></td> </tr> <tr> <td>thickness of material</td> <td></td> </tr> </tbody> </table>	variables	changed	type of material		mass of blocks		thickness of material		[1]	
variables	changed										
type of material											
mass of blocks											
thickness of material											
c	<p><i>Concept assessed: Comparison of materials on the property of strength</i></p> <p>(C) Material <b>B</b> _____</p> <p>(E) Material <b>B</b> _____ could hold the <b>most</b> _____ mass of blocks _____ before it broke _____.</p> <p>(R) It is the <b>strongest</b> _____ material.</p>	[1]									
35a	<p><i>Concept assessed: State the magnetic materials.</i></p> <p>iron / steel / nickel / cobalt</p>	[1]									

b	<p><i>Concept assessed: Make a magnet using the 'Stroke' method.</i></p> <p>Stroke _____ the iron bar with  <u>one pole</u> _____ of the magnet  repeatedly _____ in the <u>same</u>  direction.</p>	[2]	
c	<p><i>Concept assessed: Compare magnets, non-magnets and magnetic materials.</i></p> <p>There was no repulsion. / The nail could be a magnetic object that was attracted to the magnet.</p>	[1]	
36a	<p><i>Concept assessed: Differentiate between the three states of matter.</i></p> <p>Group Y: gas  Group Z: liquid</p>	[1]	
b	<p><i>Concept assessed: Differentiate the three states of matter (solid, liquid and gas) in terms of properties.</i></p> <p>Matter in group X has <u>a fixed definite volume shape</u>  but matter in group Y does not <u>have a fixed definite volume shape</u>.</p>	[1]	must compare on the same property
c	<p><i>Concept assessed: Differentiate the three states of matter (solid, liquid and gas) in terms of shape and volume.</i></p> <p>Flask <u>Q</u>, <u>Air</u> in flask Q could not <u>escape</u>  due to the rubber stopper so <u>air was occupying the space</u>.</p>	[1]	
37a	<p><i>Skill assessed: Relationship question.</i></p> <p>As the distance between the torch and the cube <u>increases</u>, the length of the shadow <u>decreases</u>.</p>	[1]	



b	<p><i>Concept assessed: Show an understanding of condensation.</i></p> <p>The <u>warm water vapour in the kitchen</u> came into contact with the <u>cooler inner surface on the glass door</u>, <u>lost</u> heat and <u>condensed</u> to form water droplets.</p>	[2]	
c	<p><i>Concept assessed: Investigate the effect of temperature on the rate of condensation.</i></p> <p>The <u>temperature difference</u> between the living room and the kitchen is <u>smaller</u> so there was <u>less condensation</u>.</p>	[1]	
d	<p><i>Concept assessed: Investigate how exposed surface area affects the rate of evaporation.</i></p> <p>(C) The plates <u>on the rack</u> would dry faster.</p> <p>(E) The plates on the rack had a <u>greater exposed surface area</u> in contact with the surrounding air.</p> <p>(R) The <u>rate of evaporation of water</u> was <u>faster</u>.</p>	[1]	
40a	<p><i>Concept assessed: Show an understanding that a current can only flow in a closed circuit.</i></p> <p>When there is a long heavy downpour, the water will collect in <u>park K</u>, causing the water level in parts K and L to <u>rise</u>. The foam float is raised to <u>touch the metal rods</u>. This creates a <u>closed</u> circuit, allowing <u>electric current to flow</u> through the alarm to sound it.</p>	[2]	

b	<p><i>Concept assessed: Identify electrical conductors and insulators.</i></p> <p>The aluminium foil is an electrical conductor.</p>	[1]	
c	<p><i>Concept assessed: Safety in using electricity</i></p> <p>To ensure that the user does not get electrocuted / an electric shock when he comes into contact with the device.</p> <p>OR</p> <p>To prevent the water from short-circuiting the device.</p>	[1]	<p><i>Do not accept:</i></p> <ul style="list-style-type: none"><li>- circuit will not flow / be wet</li><li>- spoil / damage / destroy the circuit</li><li>- cause sparks / circuit to explode</li></ul>

