

Name: _____ ()

Class: Primary 5 _____

CHIJ ST NICHOLAS GIRLS' SCHOOL (PRIMARY)



Primary 5 Mathematics

2024 End - Year Assessment

Paper 1

Booklet A

21 October 2024

15 questions
20 marks

Total Time for Booklets A and B: 1 hour

INSTRUCTIONS TO CANDIDATES

Do not turn over this page until you are told to do so.
Follow all instructions carefully.
Answer all questions.
Write your answers in this booklet.
The use of calculators is **NOT** allowed.

This booklet consists of 10 printed pages.

Questions 1 to 10 carry 1 mark each. Questions 11 to 15 carry 2 marks each. For each question, four options are given. One of them is the correct answer. Make your choice (1, 2, 3 or 4). Shade the correct oval (1, 2, 3, or 4) on the Optical Answer Sheet. (20 marks)

1. What is the value of the digit 1 in 10 539?

- (1) 10
- (2) 100
- (3) 1000
- (4) 10 000

2. What is the missing number in the number pattern below?

172 , 146 , 120 , 94 , , 42

- (1) 26
- (2) 52
- (3) 68
- (4) 88

3. Round 9.685 to 2 decimal places.

- (1) 9.60
- (2) 9.68
- (3) 9.69
- (4) 9.70

4. In the number line, what is the mixed number represented by W?

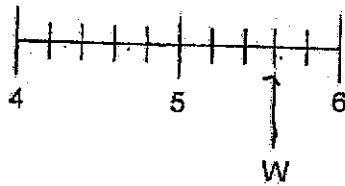

- (1) $5\frac{1}{3}$
- (2) $5\frac{3}{5}$
- (3) $5\frac{3}{4}$
- (4) $5\frac{3}{10}$

5. The ratio of the number of black crystals to the number of white crystals is 6 : 1. There are 210 crystals altogether. How many more black crystals than white crystals are there?

- (1) 180
- (2) 150
- (3) 35
- (4) 30

6. The figure is divided into 15 equal parts. What percentage of the figure is shaded?

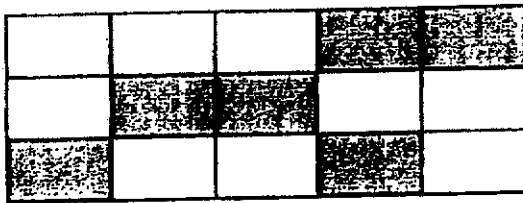

- (1) 30%
- (2) 40%
- (3) 60%
- (4) 70%

7. The table shows the number of round buttons and square buttons in 4 boxes.

Box	Number of buttons		
	Round	Square	Total
A	12	16	28
B	18	16	34
C	13	14	27
D	14	17	31

Which box has the least number of buttons?

- (1) A
- (2) B
- (3) C
- (4) D

8. The graph shows the number of fans sold at a shop from July to October.

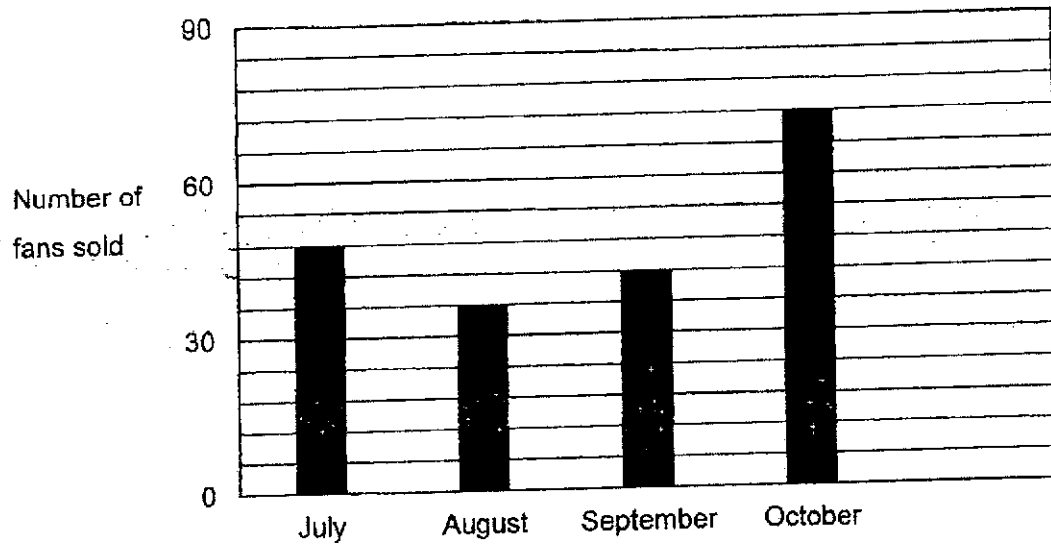

How many fans did the shop sell in July?

- (1) 33
- (2) 36
- (3) 45
- (4) 48

9. What is 45 minutes after the time shown on the clock?

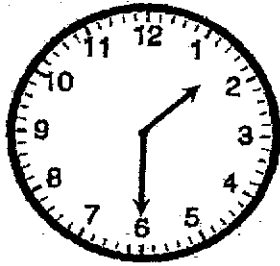

- (1) 14 15
 (2) 14 00
 (3) 13 00
 (4) 12 45

10. In the figure, CDEF is a rectangle. Find $\angle y$.

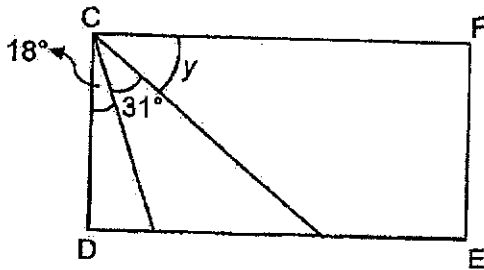

- (1) 51°
 (2) 49°
 (3) 45°
 (4) 41°

11. Raina sold tuna buns and chicken buns at a carnival. $\frac{5}{9}$ of the buns sold were tuna buns. The remaining 180 buns sold were chicken buns. Raina sold all the tuna buns at \$3 each. How much money did Raina collect from selling all the tuna buns?

- (1) \$675
- (2) \$432
- (3) \$300
- (4) \$240

12. The price of a shelf was \$220. Mr Vatheo bought it at a discount of 15%. How much did he pay for the shelf after the discount?

- (1) \$253
- (2) \$205
- (3) \$187
- (4) \$33

13. The table shows the charges for renting party props at Delightful Prop Shop.

Time	Charge
7 a.m. – 1 p.m.	\$10 per hour
1 p.m. – 10 p.m.	\$20 per hour

Arnold rented some props at 11 00. He paid \$80. At what time did Arnold return the props?

- (1) 19 00
 (2) 18 00
 (3) 16 00
 (4) 15 00
14. Bing Hui spent \$630 of his savings on a refrigerator. Then he spent $\frac{1}{5}$ of the rest of his savings on a flask. The amount of savings he had left was $\frac{1}{3}$ of his total amount of savings. What was Bing Hui's total amount of savings?

- (1) \$1050
 (2) \$1080
 (3) \$1350
 (4) \$1890

15. At first, Chandri had 70 small balloons and some large balloons. 19 small balloons and 13 large balloons burst. In the end, the total number of balloons was 4 times the number of large balloons. Find the difference between Chandri's small balloons and large balloons at first.

- (1) 32
- (2) 40
- (3) 120
- (4) 147

Name: _____ ()

Class: Primary 5 _____

CHIJ ST NICHOLAS GIRLS' SCHOOL (PRIMARY)



Primary 5 Mathematics

2024 End - Year Assessment

Paper 1

Booklet B

21 October 2024

Booklet A	20
Booklet B	25
Total (Paper 1)	45

15 questions
25 marks

Total Time for Booklets A and B: 1 hour

INSTRUCTIONS TO CANDIDATES

Do not turn over this page until you are told to do so.
Follow all instructions carefully.
Answer all questions.
Write your answers in this booklet.
The use of calculators is **NOT** allowed.

This booklet consists of 10 printed pages.

Questions 16 to 20 carry 1 mark each. Show your working clearly and write your answers in the spaces provided. For questions which require units, give your answers in the units stated. (5 marks)

Do not write in this space

16. Find the value of 301×11 .

Ans : _____

17. Find the value of $\frac{1}{6} + \frac{1}{5}$

Ans : _____

18. 2060 ml of water was poured into 2 containers equally. How many litres of water were there in one container?

Ans: _____ l

19. What is 7% of 300?

Ans: _____

20. Dulcia typed 294 words in 6 minutes. At this rate, how many words did she type per minute?

Ans: _____

Do not
write
in this
space

--

Questions 21 to 30 carry 2 marks each. Show your working clearly and write your answers in the spaces provided. For questions which require units, give your answers in the units stated. (20 marks)

Do not write in this space

21. (a) Write down one decimal between 1.1 and 1.2

Ans : _____

(b)

0

4

7

6

Use all the digits above to form the largest 4-digit number.

Ans : _____

22. The mass of a packet of flour is measured using the scale. What is the mass of the packet of flour

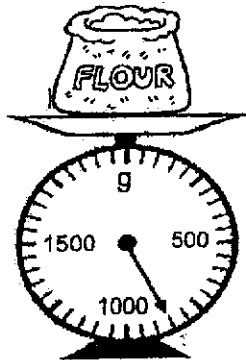

(a) in grams?

Ans : _____ 5 _____ g

(b) in kilograms?

Ans : _____ kg

--

23. The figure shows five roads drawn on a map in a square grid.

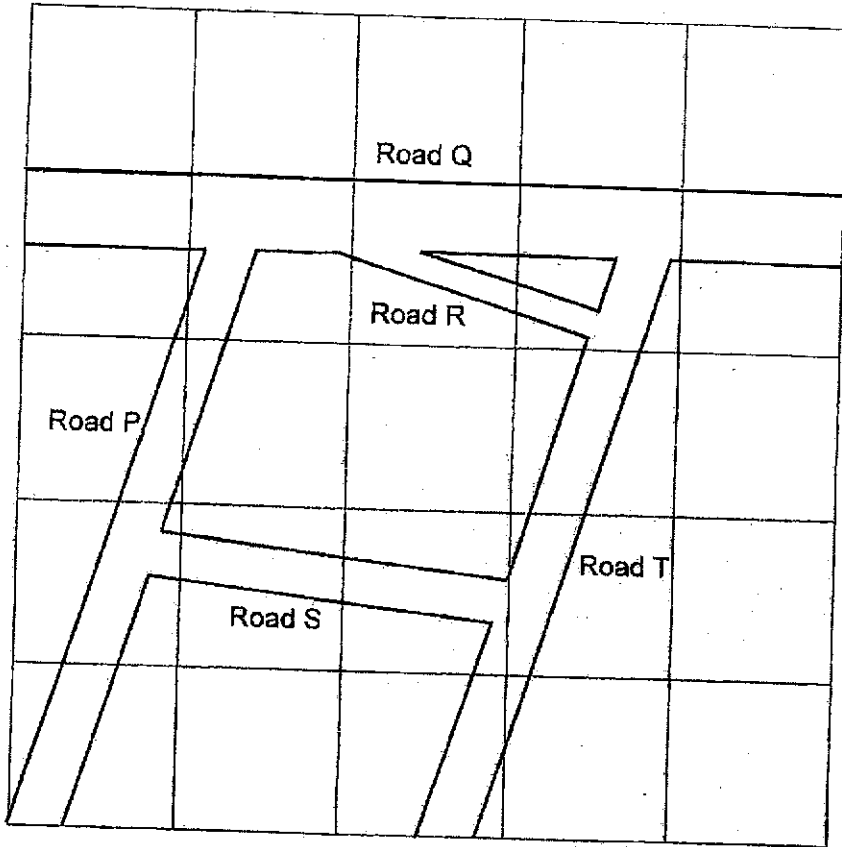

Do not write in this space

(a) Name two roads that are parallel to each other.

Ans : (a) _____ and _____

(b) Name two roads that are perpendicular to each other.

Ans : (b) _____ and _____

--

24. In the figure, TUR and VTS are triangles. $UT = UR = TR$.
Find $\angle SVR$.

Do not write in this space

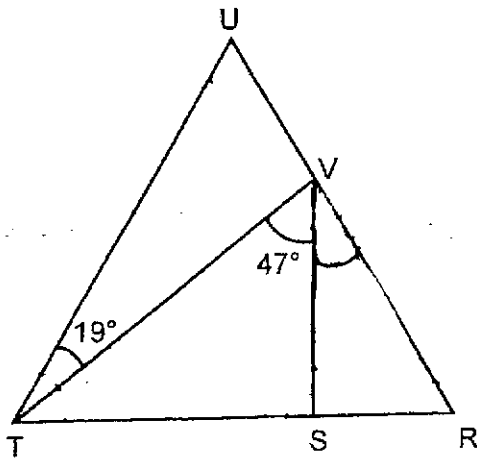

Ans : _____ °

25. Find the total area of the unshaded parts.

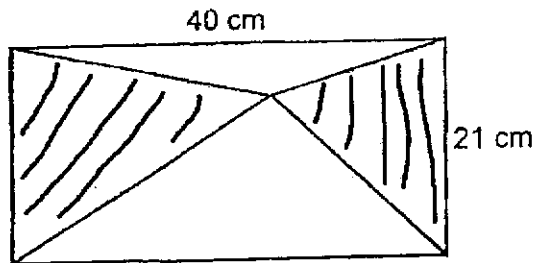

Ans : _____ cm²

--

26. The mass of a box containing 3 identical magnets was 4.1 kg. After another 5 such magnets were put into the box, the total mass of the box and the magnets was 10 kg. What is the mass of the empty box?

Do not
write in
this space

Ans : _____ kg

27. The average of three different 2-digit numbers is 25. One of the numbers is 26. What could possibly be the other two numbers?

Ans : _____ and _____

28. Mr Gerig spent \$70 on mugs and \$36 on plates.

Do not
write in
this space

Mug	Plate
2 for \$5	3 for \$9

What is the ratio of the number of plates to the total number of mugs and plates bought?

Ans : _____

29.

Fancy Gift Shop



Buy 1 purse for \$2



Buy 6 purses, get 1 purse free



Do not write in this space

Mrs Haru bought some purses from Fancy Gift Shop. She received 8 purses free of charge. She gave 1 purse to each of her 48 pupils and the remaining purses to 4 friends. All the purses were given away.

Each of the statements below is either true, false or not possible to tell from the information given. Put a tick (✓) to indicate your answer.

Statement	True	False	Not possible to Tell
Altogether, Mrs Haru gave 48 purses to all her pupils and friends.	<input type="checkbox"/>	<input type="checkbox"/>	<input type="checkbox"/>
The least amount of money Mrs Haru spent on the purses was \$112.	<input type="checkbox"/>	<input type="checkbox"/>	<input type="checkbox"/>
Mrs Haru gave 2 purses to each of her 4 friends	<input type="checkbox"/>	<input type="checkbox"/>	<input type="checkbox"/>

MARKS:

30. Bosco saved \$15 each day while Myolie saved \$7 each day. Bosco started saving 16 days later than Myolie. How many days did Bosco take to save the same amount of money as Myolie?

Do not
write in
this space

Ans : _____

End of Paper 1

Name: _____ ()

Class: Primary 5 _____

CHIJ ST NICHOLAS GIRLS' SCHOOL (PRIMARY)



Primary 5 Mathematics
2024 End - Year Assessment

Paper 2

21 October 2024

Paper 1	45
Paper 2	55
Total Marks	100

Parent's/Guardian's Signature

Time : 1 hour 30 minutes

INSTRUCTIONS TO CANDIDATES

- Do not turn over this page until you are told to do so.
Follow all instructions carefully.
Answer all questions.
Write your answers in this booklet
The use of an approved calculator is expected, where appropriate.

This booklet consists of 17 printed pages.

Questions 1 to 5 carry 2 marks each. Show your working clearly and write your answers in the spaces provided. For questions which require units, give your answers in the units stated. (10 marks)

Do not write in this space

- 1 Evia baked 908 tarts for a party. She packed the tarts into boxes of 45 each. Some tarts could not be packed into a box. How many tarts could not be packed into a box?

Ans : _____

2. A carton contained some mangoes at first. 60 mangoes were rotten and thrown away. The number of mangoes left to the number of mangoes at first was 3 : 5. How many mangoes were there in the carton at first?

Ans : _____

2

MARKS:

--

3. (a) How many cubes are there in the solid figure?

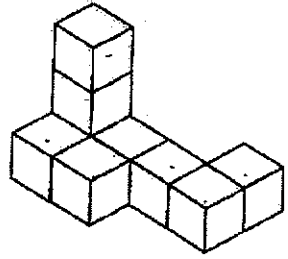

Ans : (a) _____

(b) Draw the top view of the solid figure.

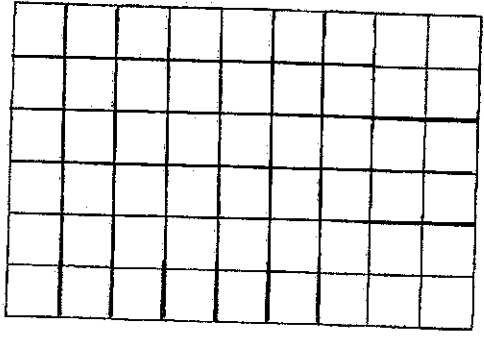
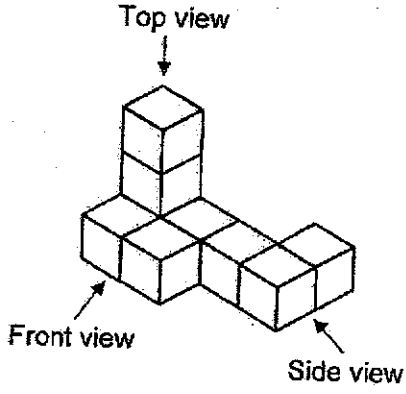

4. Shade 2 squares to form a symmetric figure with AB as the line of symmetry.

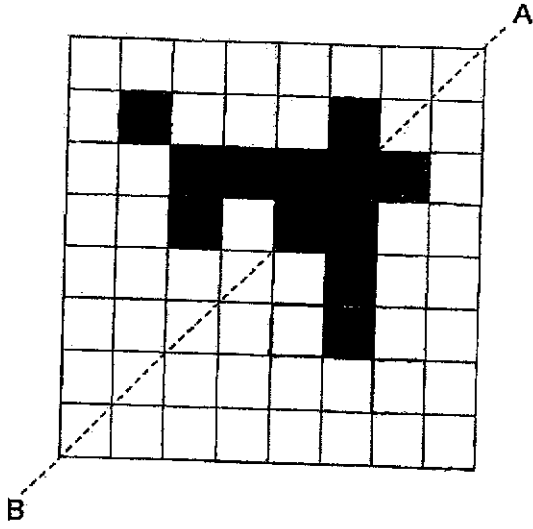

MARKS:



Do not write in this space

5. The bar graph shows the number of questions done by four pupils.

Do not write in this space

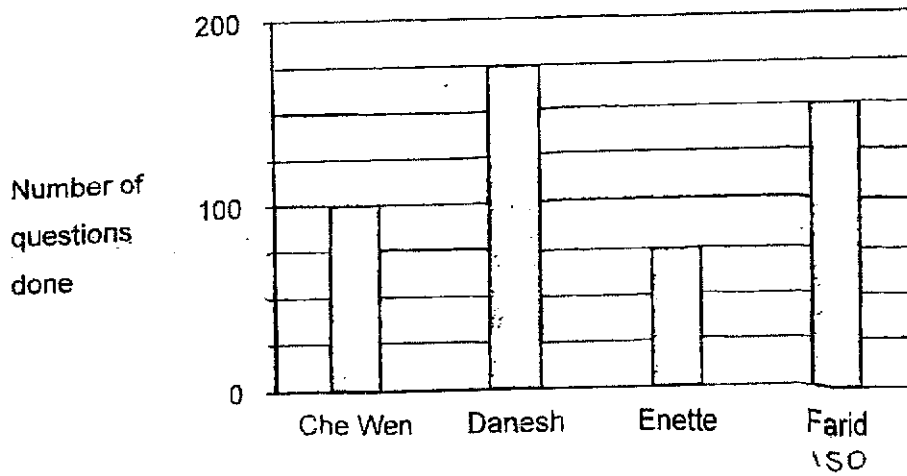

(a) Which of the four pupils did more than 100 questions?

Ans : (a) _____

(b) The number of questions done by another pupil, Gerome, was not shown in the graph. The average number of questions done by these 5 pupils was 110. How many questions did Gerome do?

Ans : (b) _____

--

For questions 6 to 17, show your working clearly and write your answers in the spaces provided. The number of marks available is shown in the brackets () at the end of each question or part-question.

(45 marks)

Do not
write
in this
space

6. A rope measuring 19.22 m was cut into some large pieces and 15 small pieces. Each large piece was 1.24 m. The length of 1 such large piece was twice the length of 1 such small piece.

(a) What was the total length of the 15 small pieces of rope?

Ans : (a) _____ [2]

(b) How many large pieces of rope were there?

Ans : (b) _____ [1]

7. At first, He Ling had \$84. She spent \$19. Jinaya spent $\frac{1}{8}$ of her money. Then He Ling had \$152 less than Jinaya.

(a) How much money did Jinaya spend?

Ans : (a) _____ [2]

(b) Find the total amount of money He Ling and Jinaya had at first.

Ans : (b) _____ [1]

Do not
write
in this
space

8. The table shows the carpark charges at Shop-a-Lot Mall.

8 am – 6 pm	\$1.80 for 1 st hour
Every additional $\frac{1}{2}$ hour or part thereof	\$1.50
Weekdays after 6 pm	\$3.50 per entry

Do not
write
in this
space

- (a) Mrs Kingston paid \$4.80 for parking her car. What was the greatest number of hours she parked her car?

Ans : (a) _____ [1]

- (b) Mr Leron parked his car from 15 45 to 19 00. How much did he pay altogether?

Ans : (b) _____ [2]

9. Mae had a number of \$5 notes and \$50 notes. She had ten \$5 notes. The ratio of the number of \$5 notes to the number of \$50 notes was 2 : 3.

Do not
write
in this
space

- (a) Find the total value of the \$50 notes.

Ans : (a) _____ [1]

- (b) Mae used some of the \$50 notes to buy groceries. The total amount of money left from all the \$5 and \$50 notes was \$550. What percentage of the notes left were \$5?

Ans : (b) _____ [2]

8

MARKS:

10. Figure 1 shows two identical rectangles, P and Q joined to square R.
Figure 2 shows rectangle P and square R.

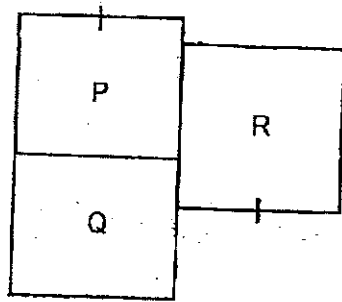

Figure 1

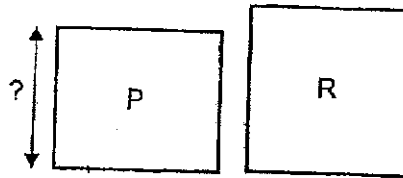

Figure 2

Do not
write
in this
space

- (a) In figure 2, the total perimeter of P and R is 84 cm. The area of R is 121 cm². What is the breadth of rectangle P?

Ans : (a) _____ [2]

- (b) What is the perimeter of figure 1?

Ans : (a) _____ [1]



11. (a) The plan of a neighbourhood is shown in the square grid. Nestor is standing at Point Y facing the library. He makes a 135° turn in the anti-clockwise direction. Where will Nestor face after the turn?

Do not write in this space

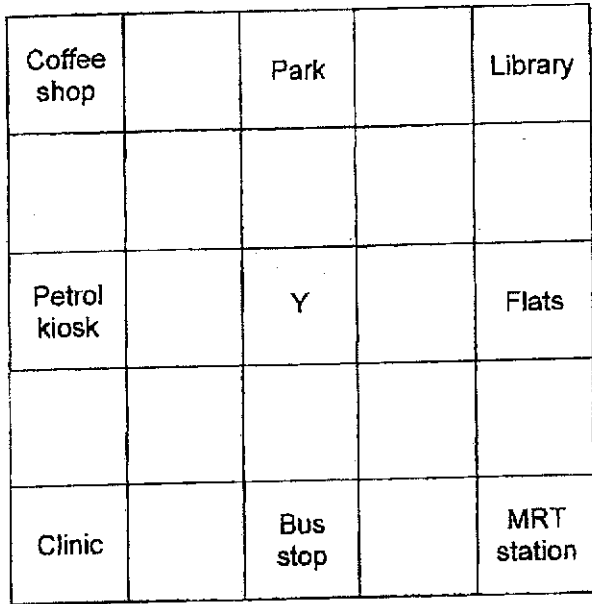

Ans : (a) _____ [1]

- (b) PQ and QR form two sides of a trapezium PQRS. PS is parallel to QR. Complete the drawing of trapezium PQRS such that PS is shorter than QR. Use a pencil to draw your figure and label it clearly.

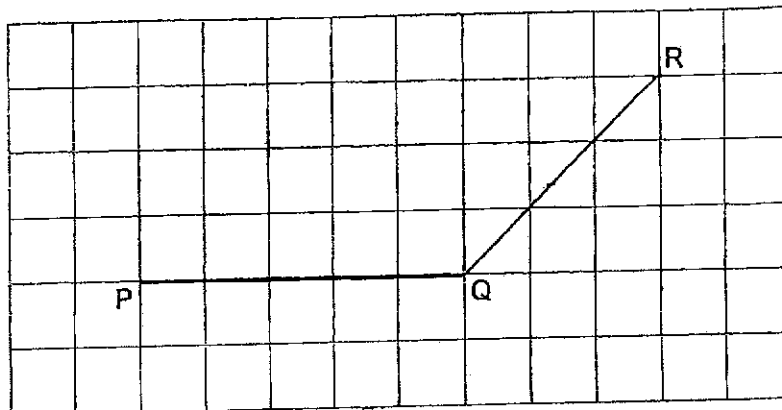

[2]

12. Uncle Tong recorded the sales of seafood at his restaurant. Part of his record was torn off.

Seafood	Amount sold (kg)	Price per kg (\$)	Total amount collected (\$)
Crab	$8\frac{7}{10}$	22.50	195.75
Fish	$12\frac{1}{2}$	12.70	
Prawn	15		

Do not write in this space

- (a) What was the total amount of money Uncle Tong collected from the sale of fish?

Ans : (a) _____ [1]

- (b) The total amount of money Uncle Tong collected from the sale of fish and prawns was \$442.25. How much did 1 kg of prawns cost?

Ans : (b) _____ [1]

- (c) A customer bought crabs and prawns with a \$100 note. He received a change of \$6.85 after he bought $1\frac{1}{5}$ kg of crabs. What was the mass of prawns that the customer bought?

Ans : (c) _____ [2]

13. Zac used dots and lines to form the figures shown. The figures followed a pattern. He recorded the number of dots and lines used for each figure in the table.

Do not write in this space

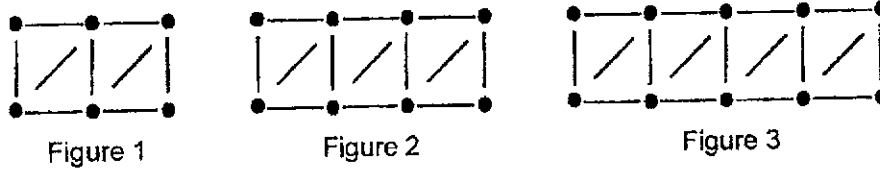

Figure Number	Number of dots	Number of lines
1	6	9
2	8	13
3	10	17
4		

- (a) Complete the table above for Figure 4. [1]
- (b) How many dots were there in Figure 9?

Ans : (b) _____ [1]

- (c) In which figure number did Zac use 65 lines?

Ans : (c) Figure number _____ [2]

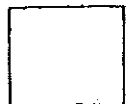

14. The line graph shows the amount of time Pawan spent on his computer over 5 weeks.

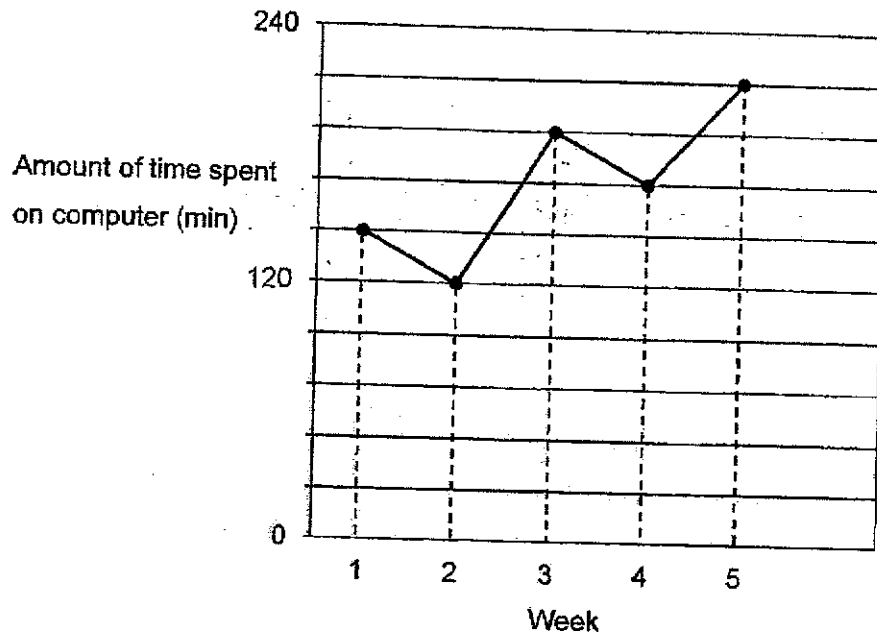

Do not
write
in this
space

- (a) What was the total amount of time Pawan spent on his computer in Week 1 and Week 3?

Ans : (a) _____ [2]

- (b) In Week 5 and Week 6, Pawan spent a total of 456 minutes on his computer. How much time did he spend on his computer in Week 6?

Ans : (b) _____ [1]

- (c) In Week 7, Pawan spent 40% of the amount of time spent in Week 6 on his computer. How much time did Pawan spend on his computer in Week 7?

Ans : (c) _____ [1]



15. EFGH is a trapezium and HJKL is a rhombus. $\angle EHK = 154^\circ$.

Do not write in this space

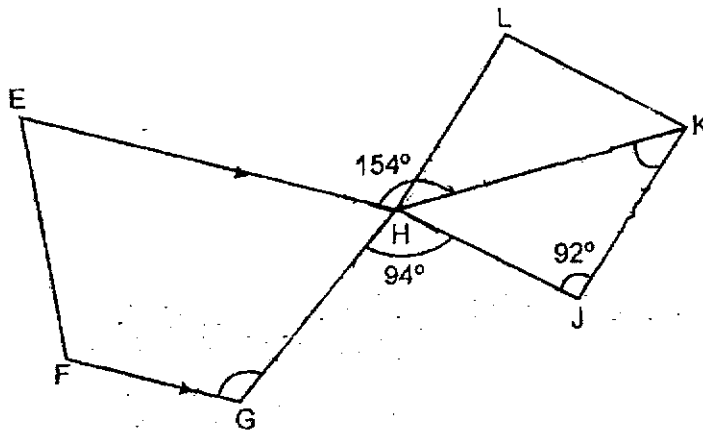

(a) Find $\angle HKJ$.

Ans : (a) _____ [2]

(b) Find $\angle FGH$.

Ans : (b) _____ [2]

(c) In the statement, circle the words that describe $\angle GHJ$ and $\angle LHJ$:

GHL (is / is not) a straight line because
 $\angle GHJ$ and $\angle LHJ$ (do / do not) add up to 180°

[1]

16. At 5 p.m., a tank measuring 98 cm by 35 cm by 60 cm is $\frac{1}{3}$ filled with water.
 At 6 p.m., 1.08 ℓ of water is poured into the tank. A container measuring 35 cm by 35 cm by 70 cm is empty.

Do not write in this space

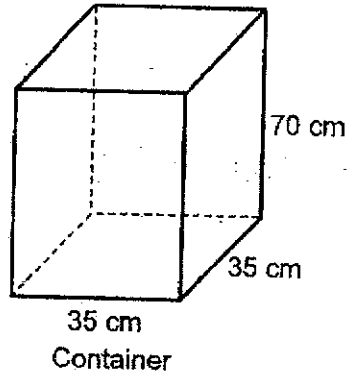
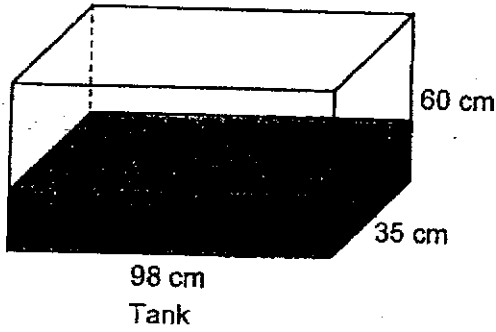

- (a) What is the total amount of water in the tank at 6 p.m.?

Ans : (a) _____ [2]

- (b) After 6 p.m., all the water in the tank is poured into the empty container without overflowing. How much more water needs to be added to the container so that the water level in the container is 12 cm from the top?

Ans : (b) _____ [3]



17. At an exhibition, $\frac{4}{7}$ of the visitors were children and the rest were adults.

$\frac{5}{6}$ of the adults were women.

(a) What fraction of the visitors were men?

Do not
write
in this
space

Ans : (a) _____ [1]

(b) There were 252 more children than men. How many children were there altogether?

Ans : (b) _____ [2]



- (c) The ticket price for the exhibition was \$6 for each child and \$11 for each adult. What was the total amount of money collected from all the children and the adults?

Do not
write
in this
space

Ans : (c) _____ [2]

The End

SCHOOL : CHIJ ST NICHOLAS GIRLS' SCHOOL (PRIMARY)
 LEVEL : PRIMARY 5
 SUBJECT : MATHEMATICS
 TERM : SA2

PAPER 1

BOOKLET A

Q1	Q2	Q3	Q4	Q5	Q6	Q7	Q8
4	3	3	2	2	2	3	4
Q9	Q10	Q11	Q12	Q13	Q14	Q15	
1	4	1	3	3	2	2	

BOOKLET B

Q16	3311
Q17	$\frac{11}{30}$
Q18	1.03
Q19	21
Q20	$294 \div 6 = 49$
Q21 (a)	1.15
Q21 (b)	7640
Q22 (a)	$500\text{g} \div 10 = 50\text{g}$ $800\text{g} + 50\text{g} = 850\text{g}$
Q22 (b)	0.85kg
Q23 (a)	P and T
Q23 (b)	T and R
Q24	$\angle VTS = 60^\circ - 19^\circ = 41^\circ$ $\angle SVR = 180^\circ - 41^\circ - 60^\circ - 47^\circ = 32^\circ$

Q25	$\frac{1}{2} \times 20 \times 21 = 420$												
Q26	$8 - 3 = 5$ $10 - 4.1 = 5.9$ 5 magnets = 5.9 $1 \text{ magnet} = 5.9 \div 5 = 1.18$ $3 \text{ magnets} = 1.18 \times 3 = 3.54$ $1 \text{ empty box} = 4.1 - 3.54 = 0.56$												
Q27	$25 \times 3 = 75$ $75 - 26 = 49$ $49 = 21 + 28$												
Q28	$70 \div 5 = 14$ No. of mugs bought = $14 \times 2 = 28$ $36 \div 9 = 4$ No. of plates bought = $4 \times 3 = 12$ Total no. plates and mugs = $28 + 12 = 40$ <u>No. of plates : Total no. of plates and mugs</u> <table style="margin-left: 40px;"> <tbody> <tr> <td>12</td> <td>:</td> <td>40</td> </tr> <tr> <td>3</td> <td>:</td> <td>10</td> </tr> </tbody> </table>	12	:	40	3	:	10						
12	:	40											
3	:	10											
Q29	<table border="1" style="margin-left: 40px;"> <thead> <tr> <th>True</th> <th>False</th> <th>Not possible to Test</th> </tr> </thead> <tbody> <tr> <td></td> <td style="text-align: center;">✓</td> <td></td> </tr> <tr> <td></td> <td style="text-align: center;">✓</td> <td></td> </tr> <tr> <td></td> <td></td> <td style="text-align: center;">✓</td> </tr> </tbody> </table>	True	False	Not possible to Test		✓			✓				✓
True	False	Not possible to Test											
	✓												
	✓												
		✓											
Q30	$7 \times 16 = 112$ $15 - 7 = 8$ $112 \div 8 = 14$												

PAPER 2

Q1	$908 \div 45 = 20R8$
Q2	$5 - 3 = 2$ $60 \div 2 = 30$ $30 \times 5 = 150$
Q3 (a)	9
Q3 (b)	
Q4	
Q5 (a)	Danesh and Farid
Q5 (b)	$110 \times 5 = 550$ $100 + 175 + 75 + 150 = 500$ $550 - 500 = 50$
Q6 (a)	1 small piece = $1.24\text{m} \div 2 = 0.62\text{m}$ 15 small pieces = $0.62\text{m} \times 15 = 9.3\text{m}$
Q6 (b)	$19.22\text{m} - 9.3\text{m} = 9.92\text{m}$ $9.92\text{m} \div 1.24\text{m} = 8$
Q7 (a)	$\$84 - \$19 = \$65$

	$7 \text{ units} = \$65 + \$152 = \$217$ $1 \text{ unit} = \$217 \div 7 = \31					
Q7 (b)	$\$31 \times 8 = \248 $\$248 + \$84 = \$332$					
Q8 (a)	First hour: $\$4.80 - \$1.80 = \$3$ 2 half hours: $\$3 \div \$1.50 = 2$ $2 \times \frac{1}{2} \text{ h} = 1 \text{ h}$ $1 \text{ h} + 1 \text{ h} = 2 \text{ h}$					
Q8 (b)	<table style="margin-left: auto; margin-right: auto; border-collapse: collapse;"> <tr> <td style="text-align: center; padding: 5px;">1 hour \$1.80</td> <td style="text-align: center; padding: 5px;">30 min \$1.50</td> <td style="text-align: center; padding: 5px;">30 min \$1.50</td> <td style="text-align: center; padding: 5px;">15 min \$1.50</td> <td style="text-align: center; padding: 5px;">1 hour \$3.50</td> </tr> </table> $\$1.80 + (\$1.50 \times 3) + \$3.50 = \9.30	1 hour \$1.80	30 min \$1.50	30 min \$1.50	15 min \$1.50	1 hour \$3.50
1 hour \$1.80	30 min \$1.50	30 min \$1.50	15 min \$1.50	1 hour \$3.50		
Q9 (a)	<u>No. of \$5 notes : No. of \$50 notes</u> $2 \quad : \quad 3$ $10 \quad : \quad 15$ $\$50 \times 15 = \750					
Q9 (b)	$\$5 \times 10 = \50 $\$550 - \$50 = \$500$ No. of \$50 notes left = $\$500 \div 50 = 10$ Total no. of notes left = $10 + 10 = 20$ $\frac{10}{20} \times 100 = 50\%$					
Q10 (a)	$11 \times 11 = 121$ $11 \times 4 = 44$ $84 - 44 = 40$ $11 \times 2 = 22$ $40 - 22 = 18$ $18 \div 2 = 9$					
Q10 (b)	$9 + 9 + 9 + (4 \times 11) = 80$					
Q11 (a)	Petrol kiosk					

Q11 (b)	
Q12 (a)	$12\frac{1}{2} \times \$12.70 = \158.75
Q12 (b)	$\$442.25 - \$158.75 = \$283.50$ $\$283.50 \div 15 = \18.90
Q12 (c)	$\$100 - \$6.85 = \$93.15$ $1\frac{1}{5} \times \$22.50 = \27 $\$93.15 - \$27 = \$66.15$ $\$66.15 \div \$18.90 = 3.5\text{kg}$
Q13 (a)	12, 21
Q13 (b)	$9 + 4 = 13$ $9 + 13 = 22$
Q13 (c)	$65 - 21 = 44$ $44 \div 4 = 11$ $11 + 4 = 15$
Q14 (a)	$144 + 192 = 336 \text{ min}$
Q14 (b)	$456 - 216 = 240 \text{ min}$
Q14 (c)	$240 \times 40\% = 96 \text{ min}$
Q15 (a)	$\angle HKJ = (180^\circ - 92^\circ) \div 2 = 44^\circ$
Q15 (b)	$\angle EHG = 360^\circ - 154^\circ - 44^\circ - 94^\circ = 68^\circ$ $\angle FGH = 180^\circ - 68^\circ = 112^\circ$
Q15 (c)	Is not, do not
Q16 (a)	$98 \times 35 \times 60 \times \frac{1}{3} = 68600\text{ml}$ $68600\text{ml} + 1.08\text{l} = 69680\text{ml}$

Q16 (b)	$70 - 12 = 58$ $(35 \times 35 \times 58) - 69680 = 1370\text{ml}$
Q17 (a)	$\text{Adult} = 1 - \frac{4}{7} = \frac{3}{7}$ $\text{Women} = \frac{5}{6} \times \frac{3}{7} = \frac{5}{14}$ $\text{Men} = \frac{3}{7} - \frac{5}{14} = \frac{1}{14}$
Q17 (b)	$4 \times 2 = 8$ $8 - 1 = 7$ $252 \div 7 = 36$ $36 \times 8 = 288$
Q17 (c)	$288 \times \$6 = \1728 $36 \times 6 = 216$ $216 \times \$11 = 2376$ $2376 + 1728 = \$4104$