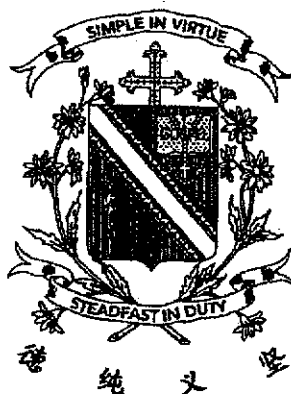

Name: _____ ()

Class: Primary 5 _____

CHIJ ST NICHOLAS GIRLS' SCHOOL**Primary 5
2024****Term 2 Weighted Assessment****SCIENCE****BOOKLET A****Total Time for Booklets A and B: 50 minutes****18 questions
36 marks****Do not open this booklet until you are told to do so.
Follow all instructions carefully.
Answer all questions.****This booklet consists of 12 printed pages.**

Section A (18 x 2 marks = 36 marks)

For each question from 1 to 18, four options are given. One of them is the correct answer. Make your choice (1, 2, 3 or 4). Shade the correct oval (1, 2, 3 or 4) on the Optical Answer Sheet provided.

1. Ben made the following statements about bacteria.

- A They can make their own food.
- B They only cause food to turn bad.
- C They have different shapes and sizes.
- D They can only be seen under the microscope.

Which of the above statements are true?

- (1) A and B only
- (2) A and D only
- (3) B and C only
- (4) C and D only

2. Which of the following is correct about flowering and non-flowering plants?

	Flowering plants	Non-flowering plants
(1)	make their own food	do not make their own food
(2)	have a strong stem	have a weak stem
(3)	reproduce by spores	reproduce by seeds
(4)	produce fruits	do not produce fruits

3. Eden made four statements about cells.

- A A cell is the smallest unit of life.
- B A bigger person has larger cells.
- C All living things consists of many cells.
- D Cells can be of different shapes and sizes.

Which of the statements are correct?

- (1) A and B only
- (2) A and D only
- (3) B and C only
- (4) C and D only

4. Raelyn wanted to find out if the number of leaves affect the amount of water absorbed by the plant.

Set-up	A	B	C	D
Colour of leaves	green	red	green	green
Number of leaves at the start of the experiment	15	10	15	10
Amount of water added to the plant daily (ml)	100	50	50	100
Location of the set-up	field	field	classroom	field

Which of the two set-ups should Raelyn use?

- (1) A and B
 (2) A and D
 (3) B and C
 (4) C and D
5. Study the three cells shown below.

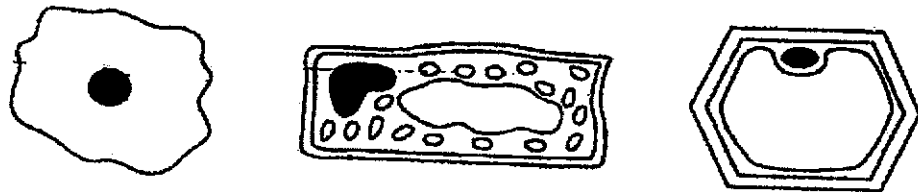

Which of the following statements is true about all the three cells?

- (1) They are plant cells.
 (2) They can make food.
 (3) They have a regular shape.
 (4) They allow certain substances to enter the cell.

6. The diagram shows the direction of blood flow in some parts of the body.

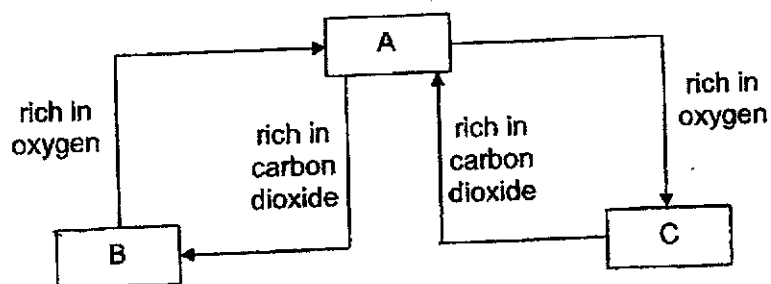

What do A, B and C represent?

	A	B	C
(1)	lungs	other parts of the body	heart
(2)	heart	lungs	other parts of the body
(3)	lungs	heart	other parts of the body
(4)	heart	other parts of the body	lungs

7. Study the diagram below.

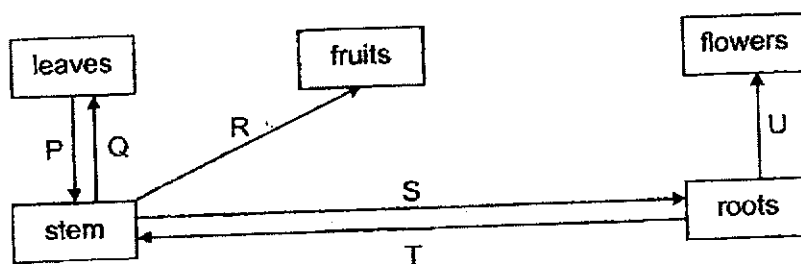

Which arrows show the correct direction in which food is transported in a plant?

- (1) P, R and S only
- (2) P, S and U only
- (3) Q, T and U only
- (4) Q, R and T only

8. The table shows the pulse rate of Nelson and Serene during an exercise.

Time (min)	Pulse rate (beats per min)	
	Nelson	Serene
0	75	80
2	82	88
4	89	97
6	95	105
8	104	108

Which of the following statements is correct?

- (1) Serene's pulse rate is slower than Nelson's pulse rate.
- (2) Nelson breathed in more oxygen per breath as compared to Serene.
- (3) Both their pulse rates return to pulse rate at rest after 10 minutes of rest.
- (4) Nelson's pulse rate increased more than Serene's pulse rate at the end of 8 minutes.

9. The diagram below shows a bicycle.

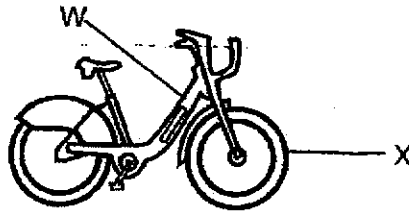

Which of the following is the most important property for materials used to make parts W and X?

	Property	
	Part W	Part X
(1)	waterproof	float on water
(2)	strong	float on water
(3)	waterproof	flexible
(4)	strong	flexible

10. Two beakers A and B were filled to the 30 cm³ mark with marbles and sand respectively as shown below.

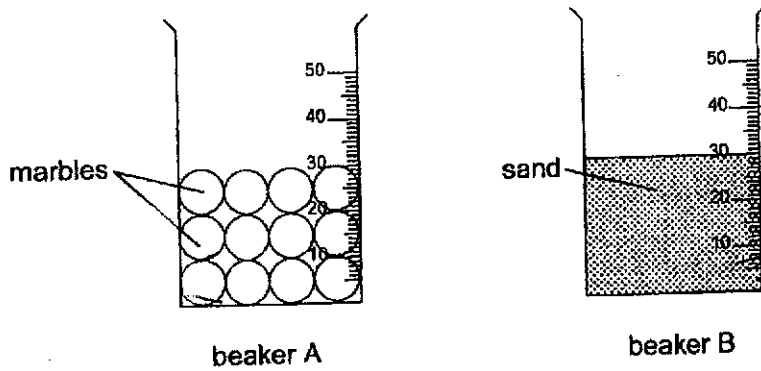

Which of the following shows the total volume of the mixture in each beaker after 20 cm³ of water was pour into each of the beaker?

Volume of mixture (cm ³)		
	Beaker A	Beaker B
(1)	50	50
(2)	45	40
(3)	40	45
(4)	40	40

11. Magnet Y was hung on a spring coil as shown in diagram 1. Bar Z was then placed below magnet Y as shown in diagram 2. Diagram 2 show the changes when bar Z was placed below magnet Y.

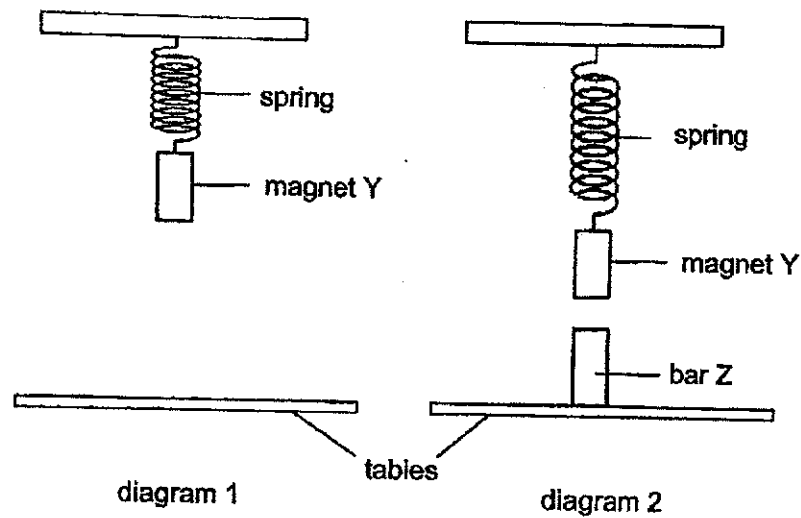

Which of the following could be a possible reason for the above observation when bar Z was placed below magnet Y?

- (1) Magnet Y became heavier.
- (2) Bar Z is a magnetic material.
- (3) Like poles of Y and Z were facing each other.
- (4) The magnetic strength of magnet Y increased.

12. Study the chart below.

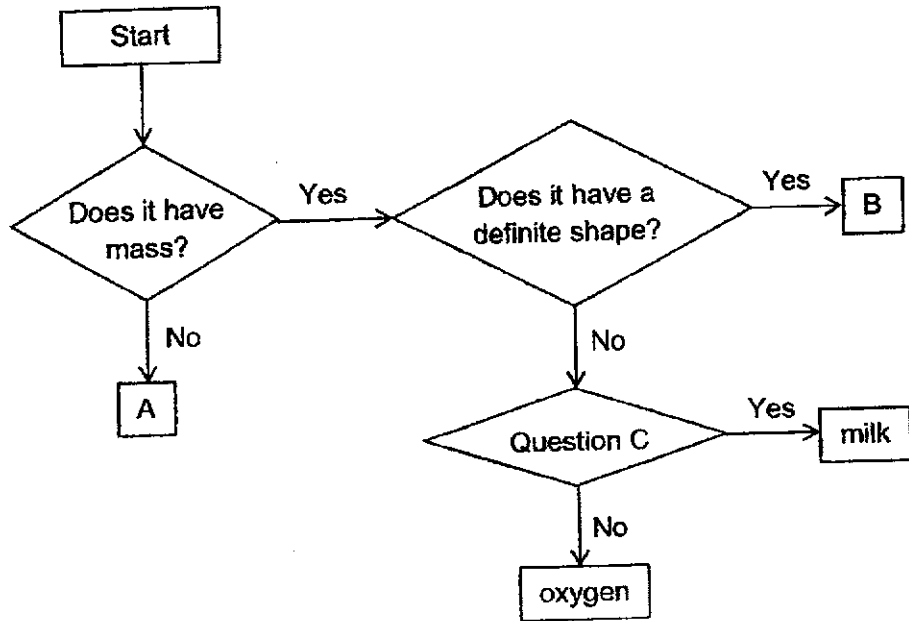

Which of the following correctly represents A, B and question C?

	A	B	Question C
(1)	air	music	Does it have a definite volume?
(2)	light	paper	Does it have a definite volume?
(3)	fire	eraser	Can it be compressed?
(4)	shadow	water	Can it be compressed?

13. Ranelle walks from point A to D as shown in the diagram below.

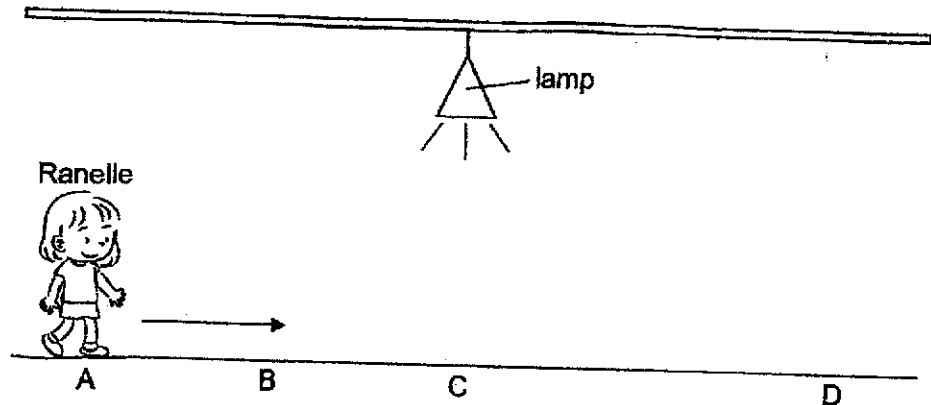

Which of the following graphs correctly shows the changes in the length of Ranelle's shadow from point A to D?

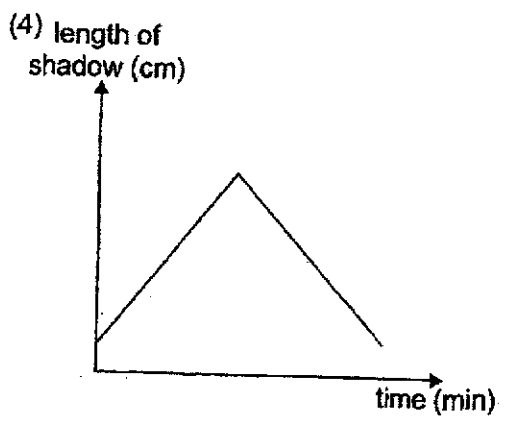
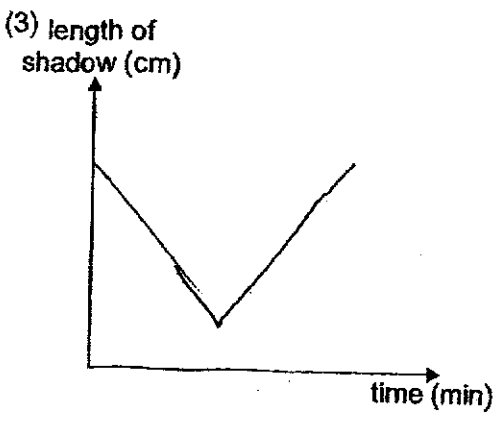
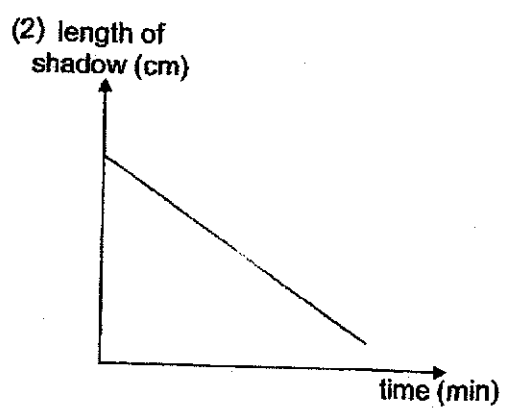
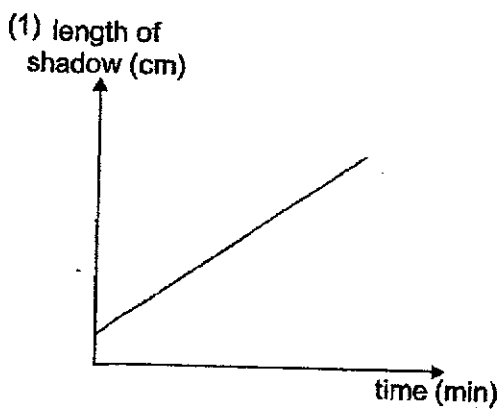

14. Four similar lumps of wax P, Q, R and S were placed on a piece of star-shaped copper wire as shown below. When the copper wire was heated at a certain point, wax R melted first, followed by Q, S and P.

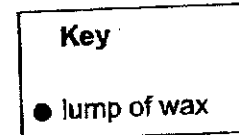
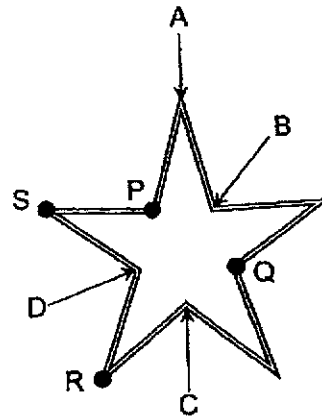

At which point was the wire most likely heated?

- (1) A
 - (2) B
 - (3) C
 - (4) D
15. The diagram below shows four beakers of water.

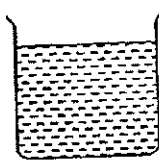

beaker W
water at
80 °C

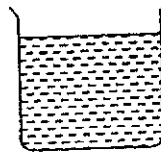

beaker X
water at
50 °C

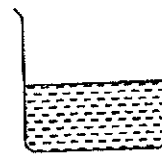

beaker Y
water at
80 °C

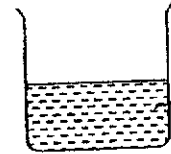

beaker Z
water at
50 °C

Which of the following statements is true?

- (1) Water in Y has less heat than water in Z.
- (2) Water in W takes a longer time to boil than water in X.
- (3) Water in X has the same amount of heat as water in Z.
- (4) Water in W takes the longest time to cool down to room temperature.

16. Four objects were placed at positions A, B, C and D in the electric circuit below. When the switch was closed, only two bulbs lit up.

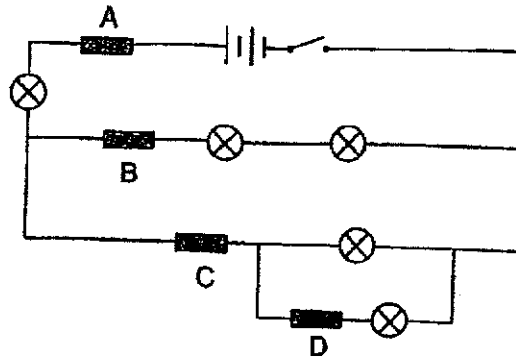

Which of the following objects were placed at positions A, B, C and D?

	A	B	C	D
(1)	copper rod	wooden stick	aluminium foil	plastic ruler
(2)	copper rod	wooden stick	plastic ruler	aluminium foil
(3)	aluminium foil	copper rod	plastic ruler	wooden stick
(4)	plastic ruler	aluminium foil	wooden stick	copper rod

17. Four circuits were set up using identical batteries and bulbs in working conditions.

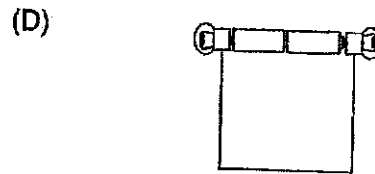
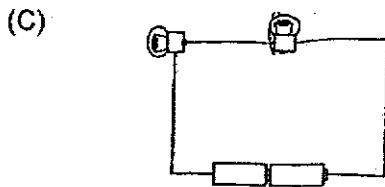
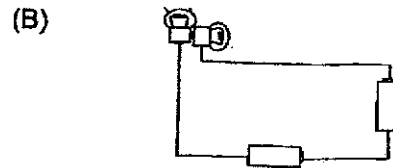
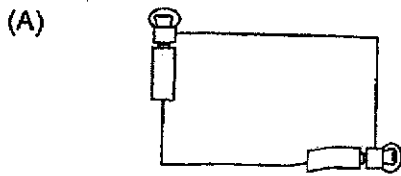

In which circuits will there be at least one bulb that lights up?

- (1) A and C only
 (2) B and D only
 (3) B, C and D only
 (4) A, B and D only

18. Leon conducted an experiment using the electric circuit as shown below. He measured the brightness of bulb X.

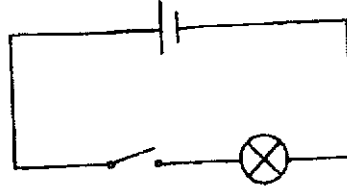

In the second experiment, he connected another identical bulb Y and a switch to the above circuit, both bulbs lit up. He observed that the brightness of bulb X decreased in the second experiment.

Which of the following statements about the electric circuit in Leon's second experiment are correct?

- A Each bulb can be switched on or off individually.
- B There is only one path for electric current to flow.
- C When one bulb fuses, the other bulb will not light up.
- D There is more than one path for electric current to flow.

- (1) A and C only
- (2) B and C only
- (3) B and D only
- (4) A and D only

~End of Booklet A~

Name : _____ ()

Class : Primary 5 _____

CHIJ ST NICHOLAS GIRLS' SCHOOL

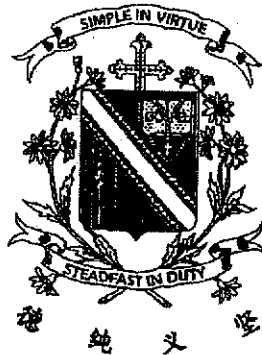

Primary 5
2024

Term 2 Weighted Assessment

SCIENCE

BOOKLET B

Total Time for Booklets A and B: 50 minutes

5 questions
14 marks

Do not open this booklet until you are told to do so.
Follow all instructions carefully.
Answer all questions.

This paper consists of 6 printed pages.

Booklet A	36
Booklet B	14
Total	50

Parent's Signature/Date

Section B (14 marks)

For questions 19 to 23, write your answers in this booklet.

The number of marks available is shown in the brackets at the end of each question or part question.

19. Brendan placed one slice of bread in each of the sealed bags as shown in the diagram below.

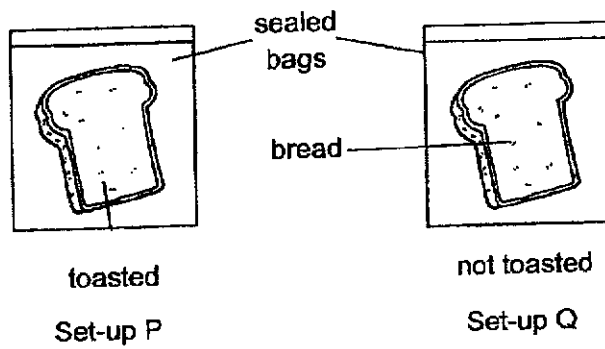

He observed the growth of mould on the 2 slices of breads for several days and recorded the results in the graph below.

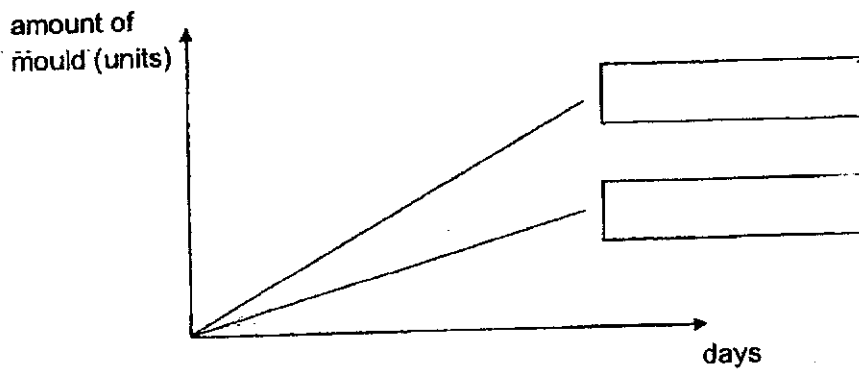

- (a) Label each line with "Set-up P" or "Set-up Q". [1]
- (b) State one other factor that could slow down mould growth. [1]

20. Joe prepared an experiment using flasks P, Q and R as shown below. He wanted to find out if the amount of roots affects the amount of water taken in by the plant.

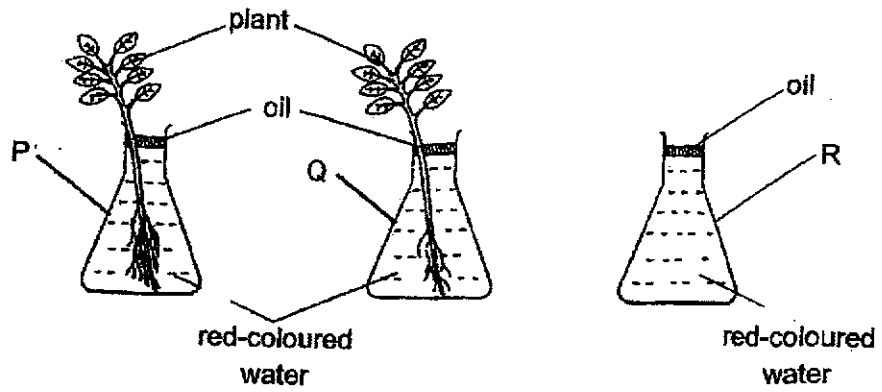

	Volume of water left (cm ³)		
	Flask P	Flask Q	Flask R
Start of the experiment	500	500	500
End of the experiment	400	450	500

(a) What is the relationship between the amount of roots and the amount of water left in the flask? [1]

(b) What is the purpose of set-up R? [1]

(c) Joe also observed that the leaves of the plants in flasks P and Q turned red. Explain his observation. [1]



21. Maita set up the following experiment in a dark room. When the lamp was turned on, a shadow was observed on the screen and the reading on the light sensor was 100 units.

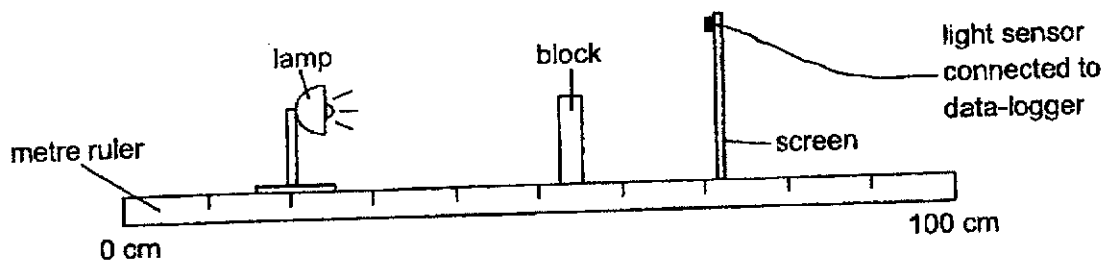

- (a) State one property of light that allows shadow to be formed. [1]

Maita moved one object in the above set-up and measured the changes in the length of the shadow. She recorded the results in the graph shown below. The reading on the light sensor remained at 100 units.

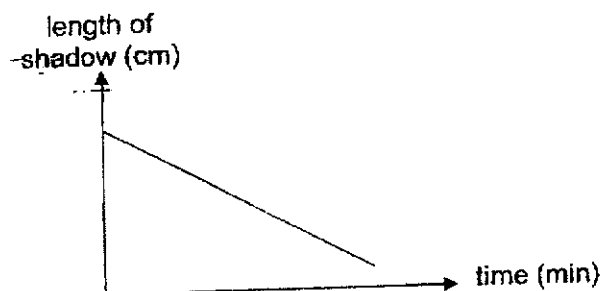

- (b) Which object was moved and in which direction was it moved? [1]

- (c) Without adding or removing any apparatus from the set-up, state one change Maita could make to find out the amount of light that can pass through the block. [1]



22. Leah took two plates X and Y, made of different materials from the cupboard and observed that plate X felt cooler to touch. She then placed an ice block on each of the plates as shown below.



The time taken for each ice block to melt completely is recorded in the table shown below.

Plate	X	Y
Time taken for ice to melt (min)	8	15

- (a) Why did the ice block on the plate X take a shorter time to melt? [2]

In the second experiment, Leah placed two similar ice blocks on two similar plates X as shown below. She measured the time each ice block took to melt.

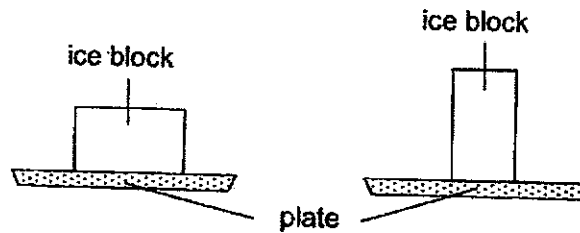

- (b) What is the aim of the second experiment? [1]



23. In the circuit below, P and Q are identical bulbs. All components are in working condition.

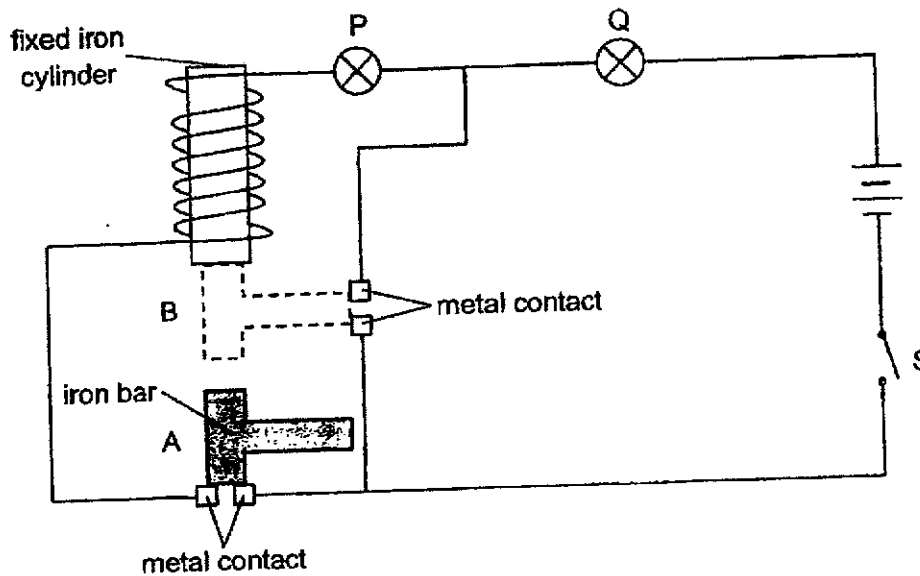

When switch S is closed, the iron bar moves up and down between points A and B.

(a) Explain why the iron bar moves to position B when switch S is closed. [2]

(b) State which bulb (s) is/are lit when the iron bar is at position A.

~ End of paper ~



SCHOOL : CHIJ PRIMARY SCHOOL
 LEVEL : PRIMARY 5
 SUBJECT : SCIENCE
 TERM : 2024 WA2

Q1	Q2	Q3	Q4	Q5	Q6	Q7	Q8	Q9	Q10
4	4	2	2	4	2	1	4	4	3
Q11	Q12	Q13	Q14	Q15	Q16	Q17	Q18		
2	2	3	3	4	1	3	2		

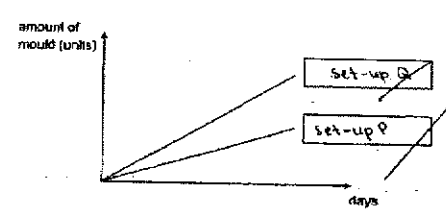
Q19)	<p>a)</p>  <p>b) Coldness</p>
Q20)	<p>a) When the amount of roots increases the amount of water left in the flask decrease.</p> <p>b) Set-up R is a control set-up. It is to compare that the amount of water left in set-up Q is solely due to the amount of roots.</p> <p>c) The roots of the plant in both flask will absorbed the red-coloured water and it will be transported by the water-carrying tube to the leaves, staining it red.</p>
Q21)	<p>a) Light travels in a straight line.</p> <p>b) The block moved nearer to the screen.</p> <p>c) Shift the light sensor downwards.</p>
Q22)	<p>a) Plate X is a better conductor of heat than plate Y. Plate X will lose heat to the ice block faster and conduct heat from the surroundings to the ice block faster.</p>

	<p>b) To find out if the time for the ice block to melt is affected by the amount of surface area of the ice block in contact to the plate.</p>
Q23)	<p>a) When switch S is closed, electricity can flow through the circuit and it will become a closed circuit. The iron cylinder will become an electromagnet and it will attract the iron bar to point B and drop to A and will drop as it too heavy and get attracted again. Thus, it will move up and down.</p> <p>b) P and Q</p>

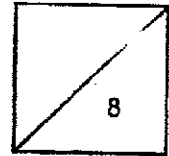

Henry Park Primary School
P5 Science
2024 Weighted Assessment 2 – Paper 1

Duration of Paper : 25 min

Name: _____ ()

Class: Primary 5 ()

Parent's Signature: _____

Task 1 (4 marks)

(a) You are given 3 materials, P, Q and R.

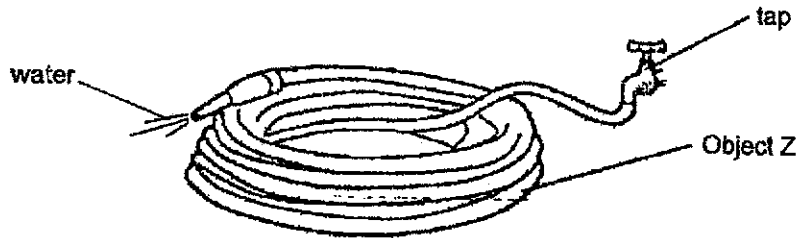

(i) Which one of the materials, P, Q or R, can be used to make object Z as shown in the diagram above? Give a reason for your choice of the answer. [1]

(ii) Object Z can be coiled and water can flow inside it. Using the property of liquids, explain how water is able to flow through it. [1]



Task 1 (Continue)

(b) You are given 2 materials, A and B, and 2 beakers of water.

Dip each of the materials into each beaker of water.

(i) Based on your observation, which material, A or B, is the most suitable for cleaning any liquid spillage on the table after a meal? [1]

(ii) Give a reason for your choice of the answer in (b)(i) [1]

Task 2 (4 marks)

You are given the following items:

- A ruler
- A cup
- A measuring cylinder
- Objects X and Y
- Water

(a) (i) Which one of the following items is the most appropriate to use to find the volume of object X?

ruler cup measuring cylinder

Give a reason for your answer. [2]

(ii) Using the water provided, find the volume of object X and write the answer in the space below. [1]

(b) Place object Y into the water in the measuring cylinder.

Based on your observation, explain why you cannot use the method you used in (a)(ii) to find the volume of object Y. [1]

