



**RAFFLES GIRLS' PRIMARY SCHOOL  
WEIGHTED ASSESSMENT 1  
PRIMARY SIX  
2024**

**SCIENCE**

Name: \_\_\_\_\_ (    )

Date : 20 February 2024

Class: P6 \_\_\_\_\_

Total Time: 50 minutes

**INSTRUCTIONS**

1. Write your name, class and index number in the spaces provided above.
2. Do not turn over this page until you are told to do so.
3. Follow all instructions carefully.
4. Answer all questions.

Your score out of 30	
Parent's signature	

1. A pot of fungi, plant and an animal were placed into sealed glass tanks W, X and Y respectively. The glass tanks contained the same amount of oxygen and carbon dioxide at the start of the experiment.

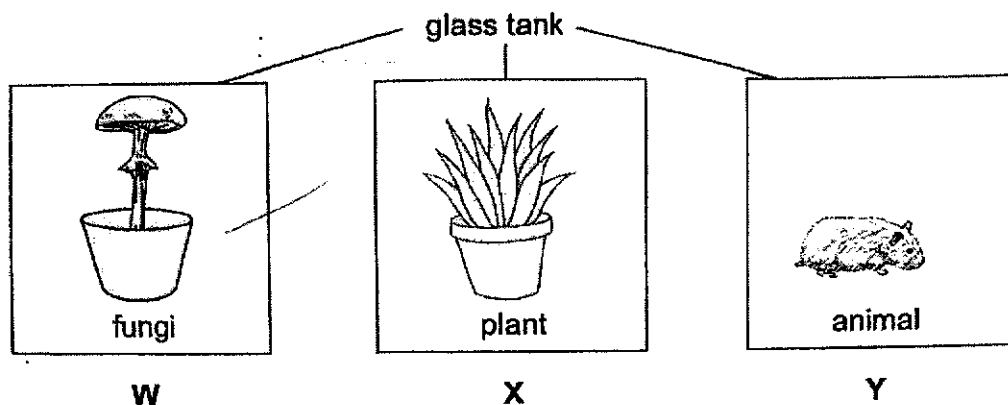

The glass tanks were kept in a well-lit room for six hours.

In the table, write 'increased' or 'decreased' in the correct box to show the change in the amount of gases in each tank after six hours. [3]

Glass tanks	Types of gases	
	Carbon dioxide	Oxygen
W		
X		
Y		

Score	3
-------	---

2. George prepared an experiment set-up by placing equal amount of mixture containing chloroplasts and liquid P into test-tubes A, B and C respectively. The mixture would turn from blue to green after photosynthesis has taken place.

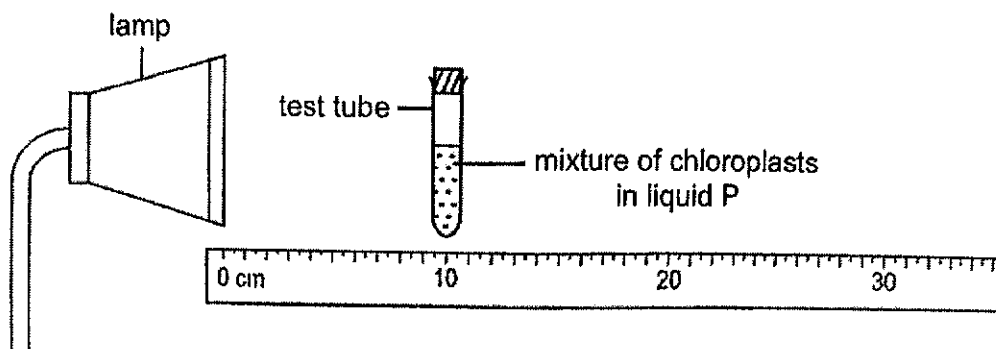

He placed the test-tubes at different distances from the lamp. Then he switched on the lamp and recorded the time taken for the blue mixture to turn green. He recorded his results in the table as shown.

Tubes	Distance from lamp (cm)	Time taken for the mixture to turn green (s)
A	10	8
B	20	21
C	30	35

- (a) What is photosynthesis? [1]

---



---

- (b) Explain how the distance from the lamp affects the rate of photosynthesis. [1]

Continue on page 3

Score	2
-------	---

*Continued from page 2*

- (c) Using the same set-up, without changing the distance between the test-tube of mixture and lamp, suggest what George can do to make the mixture turn green faster. Give a reason for your answer. [2]

---

---

Score	2
-------	---

3. Rani placed a potted plant as shown the diagram in a dark room for two days.

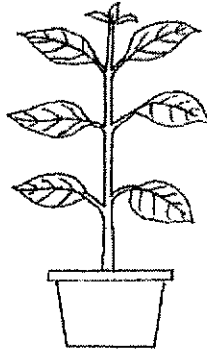

(a) After two days in the dark room, will the amount of starch in the leaves increase, decrease or stay the same? [1]

After two days, three different types of materials of identical size, J, K and L, were clipped onto leaves S, T, and U of the potted plant as shown below. The plant was watered and left in the open field for two days.

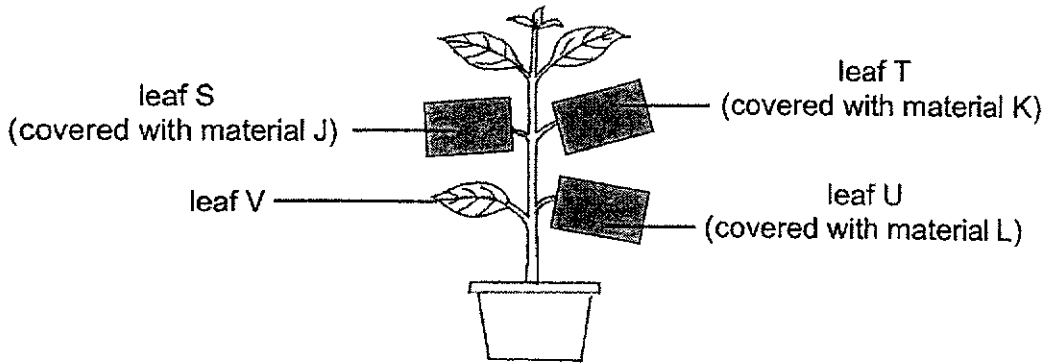

Continue on page 5

Score	1
-------	---

Continued from page 4

At the end of two days, Rani removed the three leaves, S, T and U. She conducted the starch test using iodine. Iodine changes colour from yellowish-brown to blue-black when it interacts with starch.

The table shows the results of the starch test.

Leaf	Covered with material	Colour of Iodine
S	J	Yellowish-brown
T	K	Blue-black
U	L	Yellowish-brown

- (b) Based on the results, which material, J, K or L, allows most light to pass through? Explain your answer. [2]

---

- (c) Explain the purpose of leaf V. [1]

---

Continue on page 6

Score	3
-------	---

Continued from page 5

Rani conducted another experiment to investigate the effect of temperature of the surrounding air on the rate of photosynthesis of the potted plant.

The graph shows the result of the experiment.

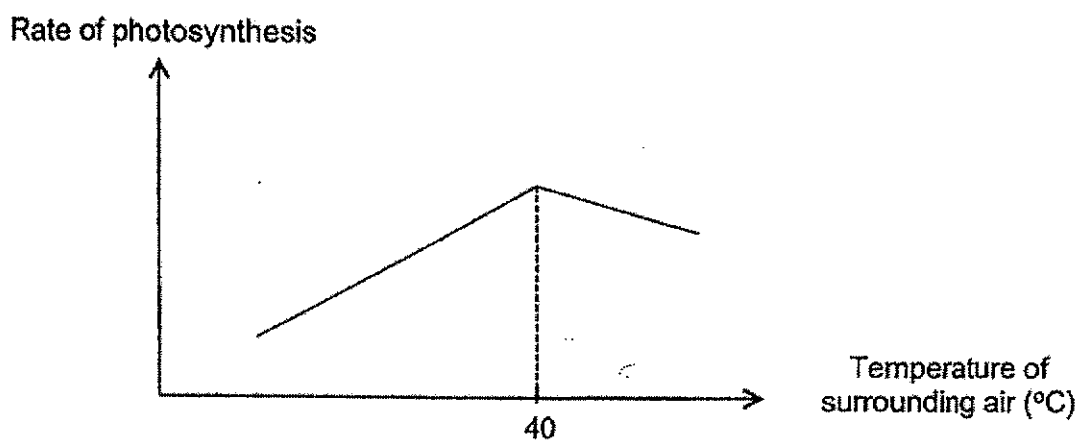

- (d) Based on the graph above, state how the rate of photosynthesis is affected by the surrounding temperature. [1]
- 

Score	1
-------	---

4. (a) What is evaporation? [1]

---



---

(b) Min Qi heated a beaker of water and plotted the change in temperature in the graph as shown.

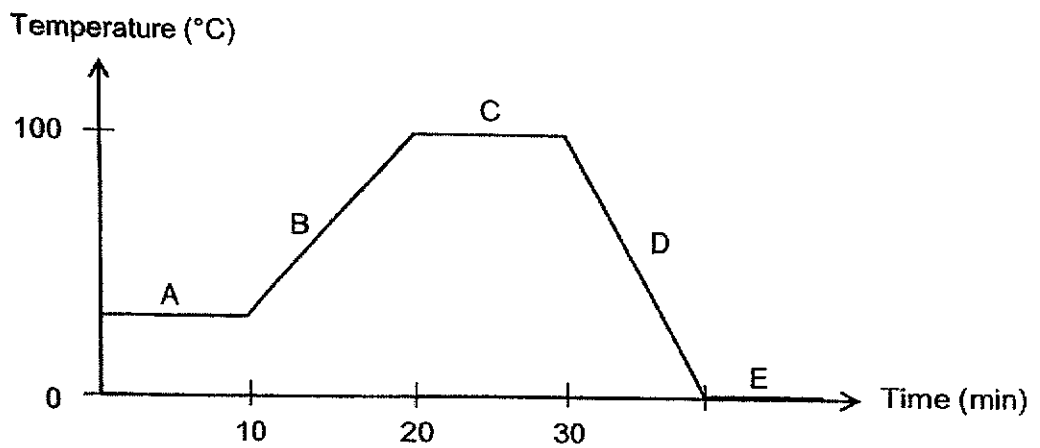

(i) The water started to boil at part \_\_\_\_\_ [1]

(ii) What process is taking place at part E? [1]

---

Score	3
-------	---

5. Henry used the set-up shown to collect clean water from saltwater solution.

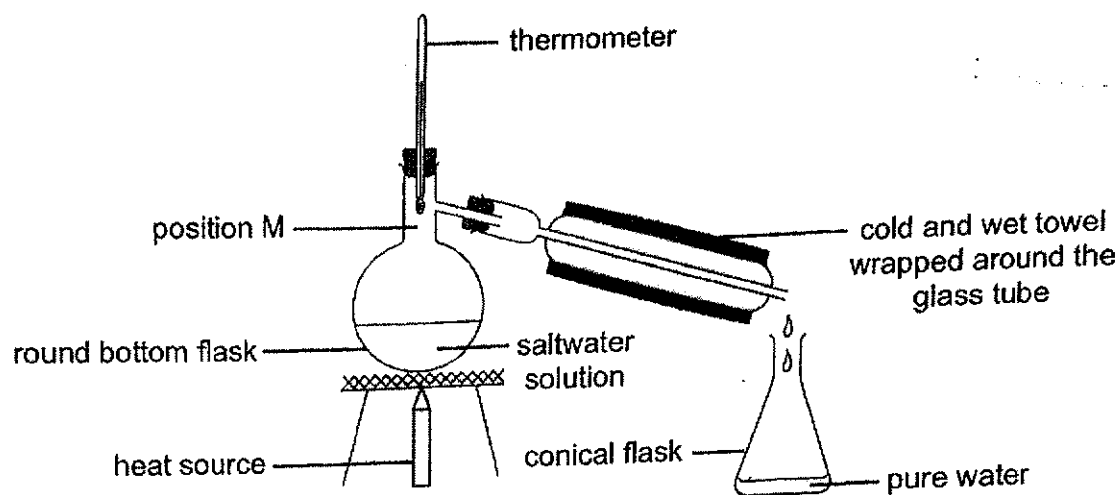

- (a) When the saltwater boils, what substance is observed at position M? [1]

- (b) Explain how pure water is collected in the conical flask. [2]

---



---

- (c) Without changing any of the apparatus in the above set-up, what can Henry do to collect pure water at a faster rate? [1]

---



---

Score	4
-------	---

6. Sandra wanted to set up a circuit using two bulbs, P and Q, an electric bell and two switches, A and B.

She set up the circuit such that when switch A was closed, only bulb P and the electric bell would function but not bulb Q. When switch B is closed only, only bulb Q will light up.

- (a) The diagram shows parts of the circuit.  
Complete the circuit such that it functions as described above. [3]

Electric bell 

 Bulb P

 Bulb Q

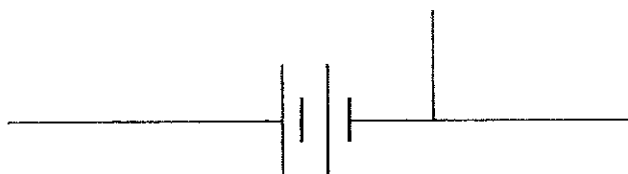

- (b) When switch A was closed and bulb P was fused, would the electric bell ring?  
Give a reason for your answer. [1]

---

Score	4
-------	---

7. Potatoes X and Y each has a mass of 50g. Potato Y was cut into smaller pieces as shown in the diagram.

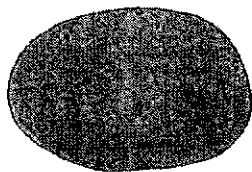

Potato X

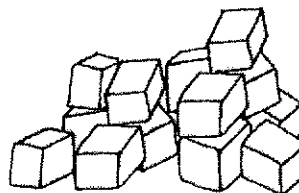

Potato Y

Ali placed the potatoes into two identical pots filled with water and heated them for the same period of time. He observed that one of the potatoes was cooked faster than the other.

- (a) Which potato, X or Y, took a shorter time to be cooked?  
Explain your answer. [2]

- (b) State another variable that must be kept constant. [1]
- 

Score	3
-------	---

8. Two similar mugs, made of materials A and B, were placed near an open window. An equal amount of cold water at  $10^{\circ}\text{C}$  was poured into the mugs at the same time as shown in the diagram.

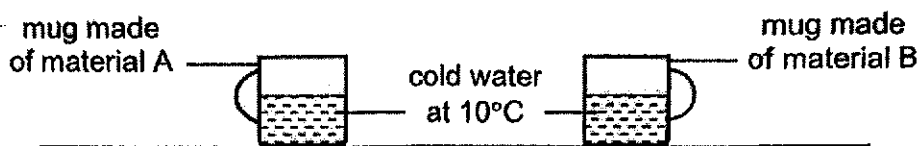

The temperature of the mugs was recorded for fifteen minutes, immediately after the cold water at  $10^{\circ}\text{C}$  was poured in. The results are as shown in the graph.

Temperature of mug ( $^{\circ}\text{C}$ )

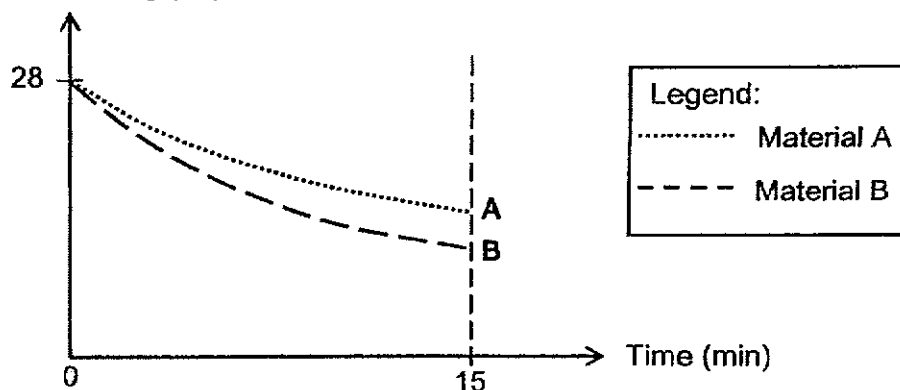

- (a) Which of the materials, A or B, should be used to make into the handle of a frying pan? Explain your answer. [2]

---



---

Mugs A and B were then left near the open window for another three hours

- (b) What would be the temperature of the water in the mugs be after three hours? Explain your answer. [2]

---

End of Paper

Score	4
-------	---

SCHOOL : RAFFLES GIRLS' PRIMARY SCHOOL  
 LEVEL : PRIMARY 6  
 SUBJECT : Science  
 TERM : 2024 WA1

Q1)	Types of gases		
	Glass tanks	Carbon dioxide	Oxygen
	W	increased	decreased
	X	decreased	increased
	Y	increased	decreased
Q2 - a)	Photosynthesis is the process whereby plants take in carbon dioxide and water and use the light energy to transform them into glucose and oxygen.		
b)	As the distance from the lamp increases, the amount of light trapped by the chloroplasts decreases, hence the rate of photosynthesis decreases.		
c)	Increase the intensity of light with a brighter light, the chloroplasts inside liquid P will receive more light and is able to make the mixture turn green faster as increase the rate of photosynthesis.		
Q3 - a)	decrease		
b)	K. The colour of the iodine at the end was blue-black which means light was able to get through K to photosynthesis and produce glucose which was then converted into starch stored in the leaf.		
c)	V is a control set-up to confirm and compare that any change in the colour of the iodine is only due to the type of material that covered.		
d)	As the temperature the surrounding air increases, the water of photosynthesis increases until it reach 40°C. As the temperature rises beyond 40°C, the rate of photosynthesis decreases.		
Q4 - a)	Evaporation is a process whereby liquid gains heat and changes state into gaseous state.		
b - i)	C		
ii)	Freezing		
Q5 - a)	Water droplets		
b)	The warmer water vapour touching the cooler surface in the glass tube, loses heat and condenses into water droplets and drip into the conical flask to be collected.		
c)	Increase the size of the heat source.		

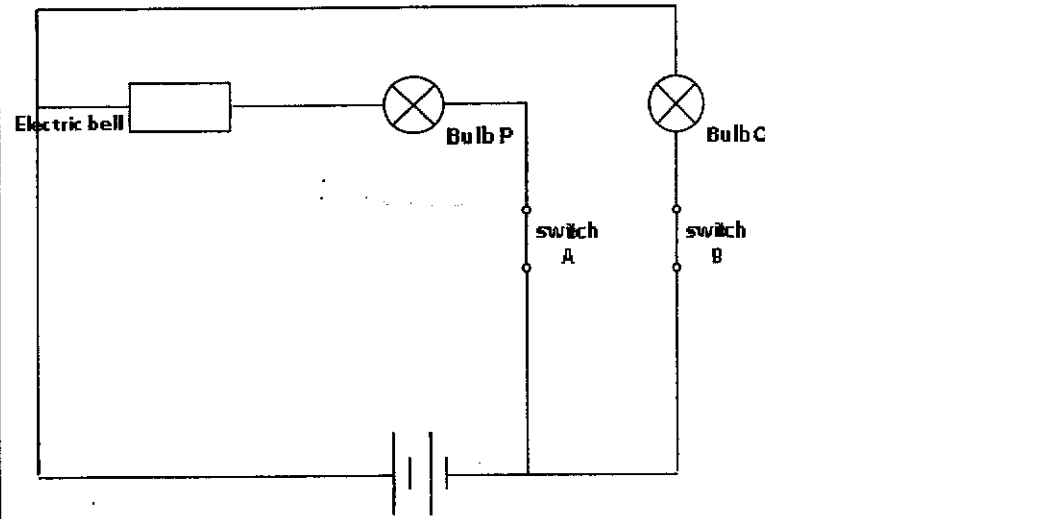
Q6 – a)	 <p>The diagram shows a series circuit containing an electric bell, Bulb P, and Bulb C. A battery is connected at the bottom. Switch A is connected in parallel with Bulb P, and Switch B is connected in parallel with Bulb C.</p>
b)	No. When the bulb fused, the electricity could not flow through the circuit.
Q7 – a)	Potato Y. The potato has a greater exposed surface in contact with the boiling water. Potato Y will gain heat from the hot water faster than Potato X.
b)	Type of potato.
Q8 – a)	A. The temperature of the mug made A decreased slower than that made of B. This shows that A is lost poorer conductor of heat as the mug lost heat to the cold water more slowly. Using material A as a handle of the frying pan will slow down heat gain by the hand from the handle.
b)	28°C. The water in the mugs gained heat from the surroundings until they reached room temperature.