



**ROSYTH SCHOOL**  
**2024 PRELIMINARY EXAMINATION**  
**MATHEMATICS**  
**PRIMARY 6**  
**PAPER 1**

Name: \_\_\_\_\_ Register No. \_\_\_\_\_

Class: Pr 6 - \_\_\_\_\_

Date: 20 August 2024 Parent's Signature: \_\_\_\_\_

Total Time for Booklets A and B: 1 hour

**BOOKLET A**

Instructions to Pupils:

1. Do not turn over this page until you are told to do so.
2. Follow all instructions carefully.
3. Answer all questions.
4. Use a 2B pencil to shade your answers on the Optical Answer Sheet (OAS).
5. The use of calculators is **NOT** allowed.

Section	Maximum Mark	Marks Obtained
Paper 1 (Booklet A)	20	

\* This booklet consists of **8** pages (including this cover page).

Questions 1 to 10 carry 1 mark each. Questions 11 to 15 carry 2 marks each.  
For each question, four options are given. One of them is the correct answer.  
Make your choice (1, 2, 3 or 4). Shade the oval (1, 2, 3 or 4) on the Optical Answer Sheet.

*All diagrams in this paper are not drawn to scale unless stated otherwise.*

(20 marks)

1. Which of the following is four hundred and two thousand and thirty-one?

- (1) 42 031
- (2) 402 031
- (3) 4 020 031
- (4) 4 002 031

2. Which of the following is the same as 9070 m?

- (1) 9 km 7 m
- (2) 9 km 70 m
- (3) 90 km 7 m
- (4) 90 km 70 m

3. The opening hours of a shop are shown below.

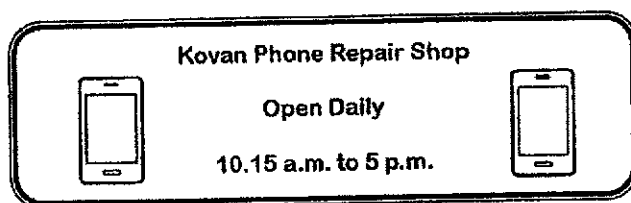

How long is the shop open each day?

- (1) 6 h 15 min
- (2) 6 h 45 min
- (3) 7 h 15 min
- (4) 7 h 45 min

4. A tank was filled with 50 litres of water at 08 00.  
Water flowed out of the tank from 08 00 to 12 00.  
The graph below shows the amount of water in the tank from 08 00 to 12 00.

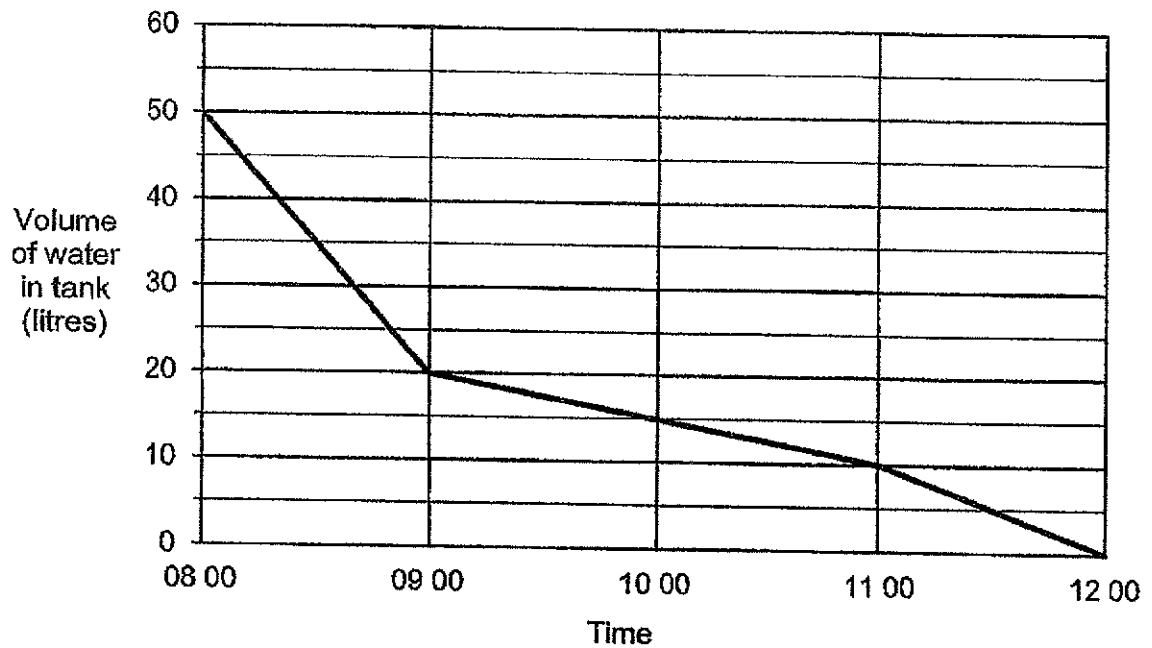

Which one-hour period was the decrease in water the greatest?

- (1) Between 08 00 and 09 00
- (2) Between 09 00 and 10 00
- (3) Between 10 00 and 11 00
- (4) Between 11 00 and 12 00

5. The table below shows the number of participants in an art class on Saturday and Sunday.

Day	Children	Adults
Saturday	16	24
Sunday	20	24

What is the percentage increase in the number of participants from Saturday to Sunday?

- (1) 10%
- (2) 20%
- (3) 25%
- (4) 4%
6. What is the value of  $\frac{31w}{10} - w + 3$  when  $w = 2$ ?

- (1) 1.2
- (2) 3.6
- (3) 7.2
- (4) 9.2

7. The figure below is made up of squares. What is the least number of square(s) to be shaded so that the figure has one vertical line of symmetry?

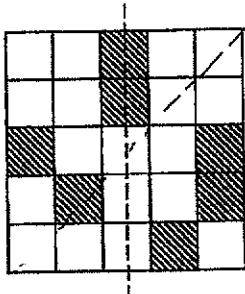

- (1) 1
- (2) 2
- (3) 3
- (4) 4

8. In the figure below, PQR is a straight line.  $AP = AQ = QR$ .  $\angle APQ = 70^\circ$ .  
Find  $\angle RAQ$ .

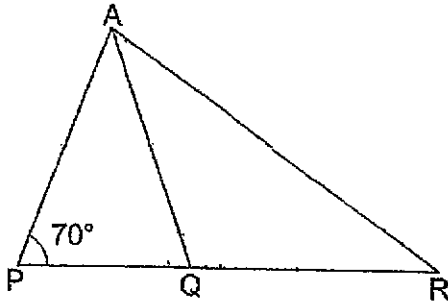

- (1)  $35^\circ$   
 (2)  $40^\circ$   
 (3)  $55^\circ$   
 (4)  $70^\circ$
9. A, B and C are three points on the grid. Point B is south of Point A and  $\angle ABC$  is  $225^\circ$ .  
In what direction is Point C from Point B?

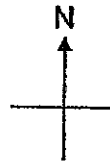
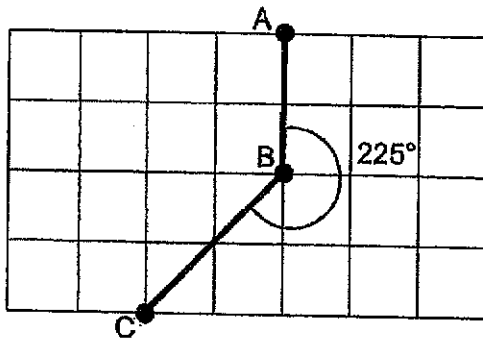

- (1) North-East  
 (2) North-West  
 (3) South-East  
 (4) South-West

10. Miss Lim travelled 3.2 km in a taxi from home to the mall. Her taxi fare was based on the charges shown below.

First km	\$4.80
Every additional 400 m or less	\$0.20

How much was her taxi fare?

- (1) \$5.40  
 (2) \$5.80  
 (3) \$6.00  
 (4) \$6.40
11. Sam spent \$42 of his money on a gift and  $\frac{2}{5}$  of the remaining money on a book. In the end, he had  $\frac{1}{4}$  of his money left. How much money did Sam have at first?
- (1) \$42  
 (2) \$70  
 (3) \$72  
 (4) \$180
12. Limin, Ming and Raju each had some money at first. Limin gave Ming \$2.50. Ming then gave Raju \$1.80. Raju then spent \$3 on a pen. In the end, they each had \$5. What was the difference between the amount Limin and Raju had at first?
- (1) \$0.50  
 (2) \$1.20  
 (3) \$1.30  
 (4) \$3.00

13. ABCD is a trapezium with AB parallel to DC.  $\angle ADC = 100^\circ$ ,  $\angle AEC = 91^\circ$  and  $\angle ABE = 52^\circ$ . Find  $\angle DAE$ .

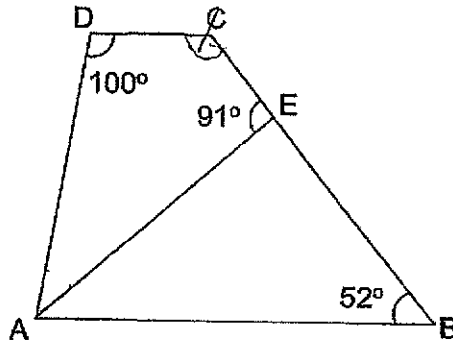

- (1)  $39^\circ$   
 (2)  $41^\circ$   
 (3)  $80^\circ$   
 (4)  $89^\circ$
14. Mary glued some identical square papers in a straight line to form a length of 5.98 m as shown below. She glued the papers by overlapping one paper on the other paper. Each overlapping part was 3 cm long. What was the number of square papers she used?

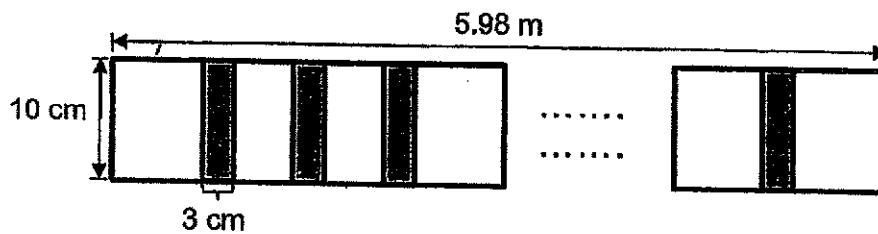

- (1) 59  
 (2) 60  
 (3) 84  
 (4) 85

15. Bala used some wire to form the figure shown below. In the figure, ABCD is a rectangle and the 4 identical triangles are equilateral triangles. The area of ABCD is  $162 \text{ cm}^2$ .

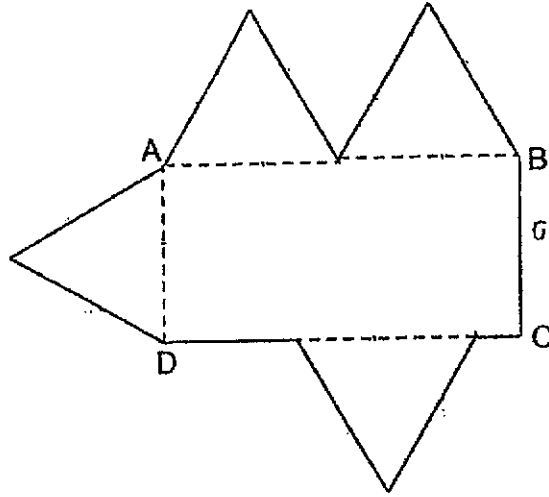

What is the perimeter of the figure?

- (1) 72 cm
- (2) 90 cm
- (3) 99 cm
- (4) 126 cm



**ROSYTH SCHOOL  
2024 PRELIMINARY EXAMINATION  
MATHEMATICS  
PRIMARY 6  
PAPER 1**

Name: \_\_\_\_\_

Register No. \_\_\_\_\_

Class: Pr 6 - \_\_\_\_\_

Date: 20 August 2024

Parent's Signature: \_\_\_\_\_

Total Time for Booklets A and B : 1 hour

**BOOKLET B**

Instructions to Pupils:

1. Do not turn over this page until you are told to do so.
2. Follow all instructions carefully.
3. Answer all questions.
4. Use a dark blue or black ballpoint pen to write your answers in the space provided for each question.
5. Do not use correction fluid/tape or highlighters.
6. The use of calculator is **NOT** allowed.

Section	Maximum Mark	Marks Obtained
Paper 1 (Booklet B)	25	

\* This booklet consists of **10** pages (including this cover page).

Questions 16 to 20 carry 1 mark each. Write your answers in the spaces provided. For questions which require units, give your answers in the units stated.

Do not write in this space

**All diagrams in this paper are not drawn to scale unless stated otherwise.** (5 marks)

16. In the number line below, P represents  $\frac{1}{8}$  and R represents  $\frac{1}{2}$ .  $PQ = QR$ . What fraction is represented by Q?

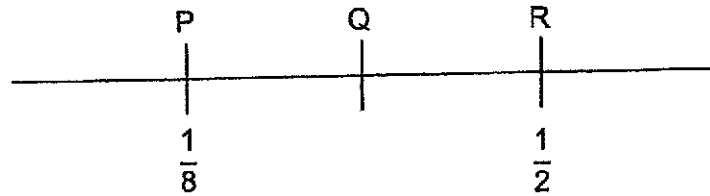

Ans: \_\_\_\_\_

17. The total mass of 9 durians is 16.2 kg. What is the average mass of the durians?

Ans: \_\_\_\_\_ kg

18. The volume of a cube is  $64 \text{ cm}^3$ . Find the length of the cube.

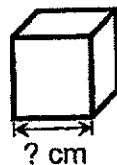

Ans: \_\_\_\_\_ cm

19. The pie chart below shows the number of pupils who chose their favourite sport in a survey. Half of the pupils chose badminton and swimming.

Do not write in this space

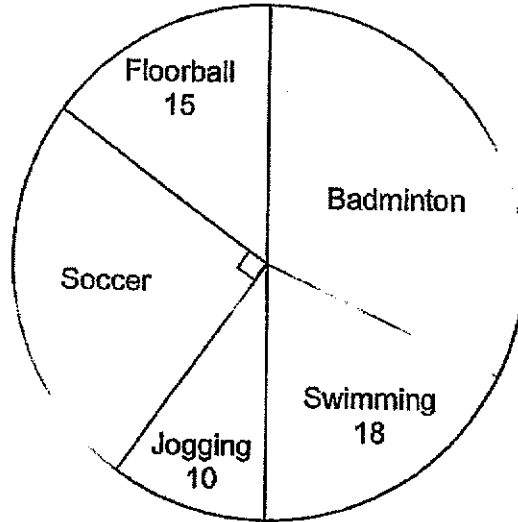

How many pupils chose badminton?

Ans: \_\_\_\_\_

20. In the figure below, AD is a straight line, AG is parallel to CF and CD is parallel to FE.  $\angle ABG = 52^\circ$  and  $AB = GB$ . Find  $\angle DCF$ .

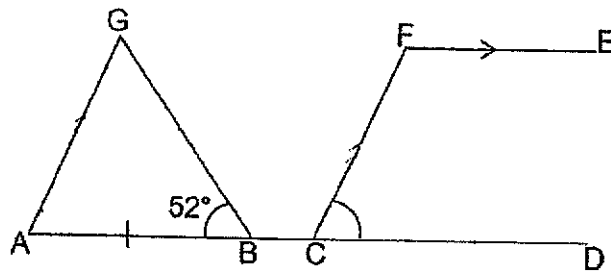

Ans: \_\_\_\_\_°

Questions 21 to 30 carry 2 marks each. Show your workings clearly in the space provided for each question and write your answers in the spaces provided. For questions which require units, give your answers in the units stated.

Do not write  
in this space

**All diagrams in this paper are not drawn to scale unless stated otherwise.**  
(20 marks)

21. Alice saves \$2 every day. Her mother gives her \$1 for every 10 days that she saves. What is the total amount of money she will have after 43 days?

Ans: \$ \_\_\_\_\_

22. The solid below is made up of 7 cubes.

Do not write  
in this space

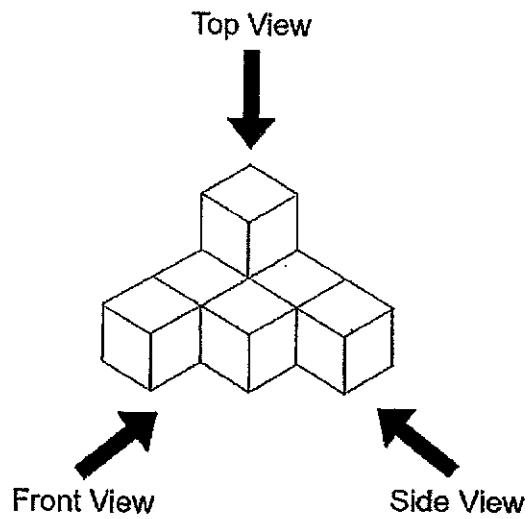

(a) Draw the top view of the solid on the grid below.

Top View

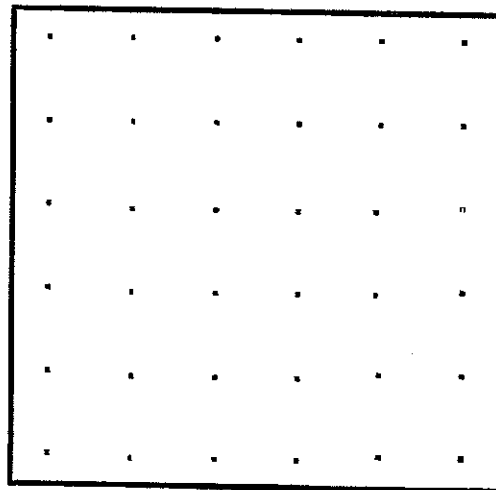

(b) Tyler painted the whole solid including the base. Then he took it apart into 7 cubes. What is the total number of faces that are painted?

Ans: (b) \_\_\_\_\_



23. Judy and her brother had some stickers. After Judy gave him 30 stickers, she had 14 stickers more than him. How many more stickers did Judy have than her brother at first?

Do not write  
in this space

Ans: \_\_\_\_\_

24. A group of students took part in a Math competition.  $\frac{3}{8}$  of the boys and  $\frac{1}{6}$  of the girls went on to the final round of the competition. There were 60 students who went on to the final round and  $\frac{3}{4}$  of them were boys. What was the total number of students who took part in this competition?

Ans: \_\_\_\_\_

25. Rectangle PQRS below is made up of a rectangle and 2 squares, A and B. Find the perimeter of rectangle PQRS in terms of  $y$ .

Do not write in this space

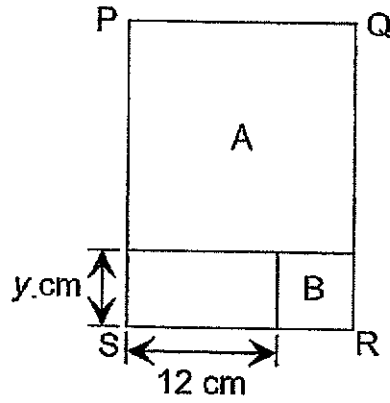

Ans: \_\_\_\_\_ cm

26. Allyn and Baxter started jogging from the same place in opposite directions along a straight path. They jogged for 45 min. At the end of the jog, they were 15 km apart. Allyn's average speed was 8 km/h. What was Baxter's average speed?

Ans: \_\_\_\_\_ km/h

27. The bar graph below shows the number of cups of milk, juice, coffee and tea sold at a shop on a Friday.

Do not write in this space

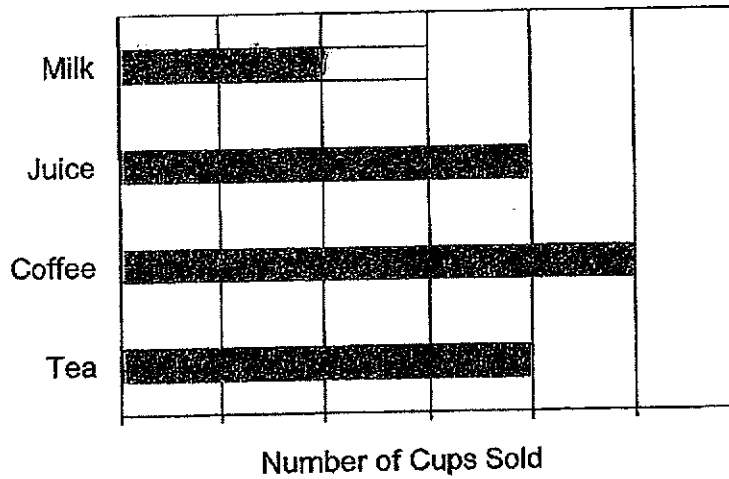

- (a) The pie chart represents the information in the bar graph. Label the correct type of drink sold for each part.

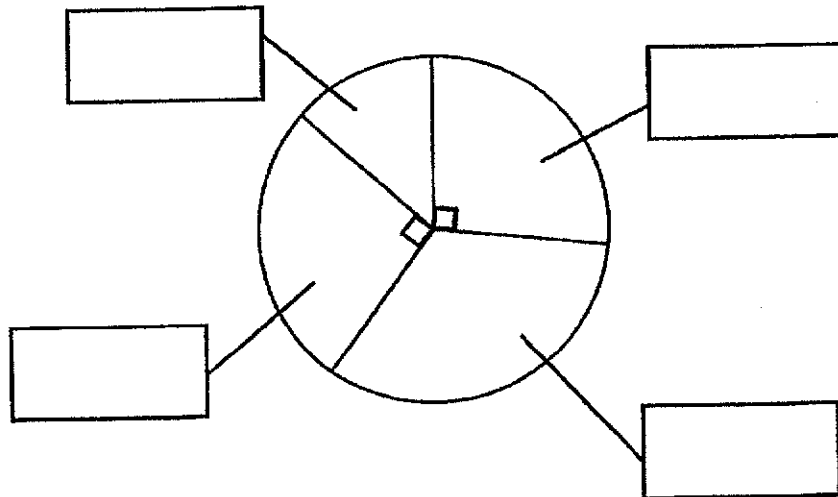

- (b) 84 cups of milk were sold. Find the total number of cups of drinks sold on Friday.

Ans: (b) \_\_\_\_\_

28. In the figure below, rectangle EFGH has an area of  $2250 \text{ cm}^2$  and triangle MNH has an area of  $750 \text{ cm}^2$ . Find the area of the shaded triangle NFG.

Do not write in this space

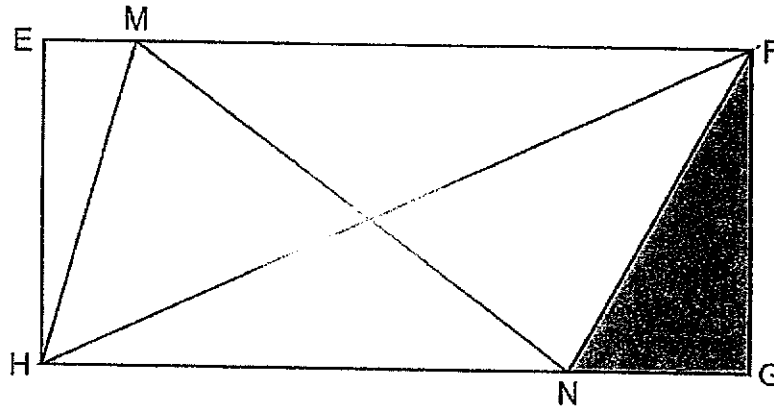

Ans: \_\_\_\_\_  $\text{cm}^2$



29. The figure below shows a triangle PQR. On the grid below, draw a parallelogram RQXY with the same area as triangle PQR without overlapping it.

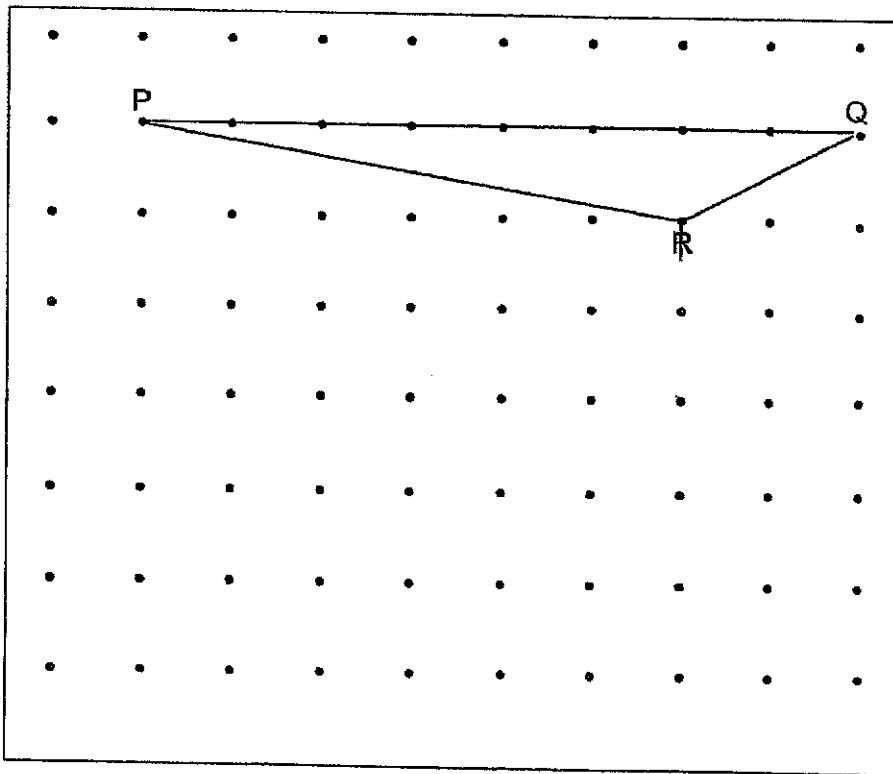

30. Match the net of each solid in the table below by writing the letter A, B, C or D on the blank.

Do not write in this space

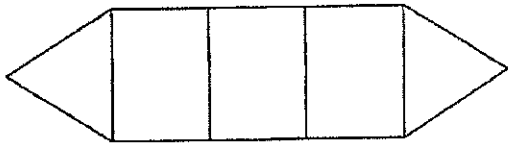

A

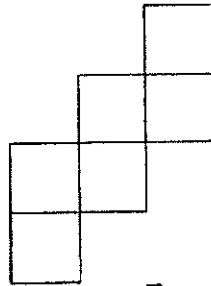

B

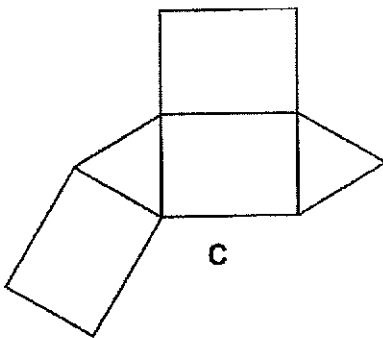

C

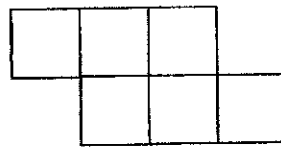

D

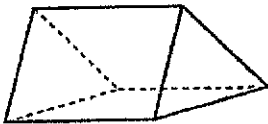
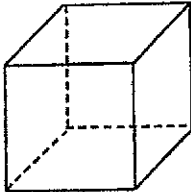
	Solid	Net
(a)	 Prism	_____
(b)	 Cube	_____



End of paper  
Have you checked your work?



**ROSYTH SCHOOL**  
**2024 PRELIMINARY EXAMINATION**  
**MATHEMATICS**  
**PRIMARY 6**  
**PAPER 2**

Name: \_\_\_\_\_

Register No. \_\_\_\_\_

Class: Pr 6 - \_\_\_\_\_

Date: 20 August 2024

Parent's Signature: \_\_\_\_\_

Time: 1 h 30 min

**Instructions to Pupils:**

1. Do not turn over this page until you are told to do so.
2. Follow all instructions carefully.
3. Answer all questions.
4. Use a dark blue or black ballpoint pen to write your answers in the space provided for each question.
5. The use of an approved calculator is allowed.
6. Do not use correction fluid/tape.
7. Do not use highlighters on any part of your answers.

Questions	Maximum Mark	Marks Obtained
Q 1 to 5	10	
Q 6 to 17	45	

Section	Maximum Mark	Marks Obtained
Paper 1	45	
Paper 2	55	
<b>Total</b>	<b>100</b>	

\* This booklet consists of 19 pages (including this cover page)

Questions 1 to 5 carry 2 marks each. Show your working clearly in the space provided for each question and write your answers in the spaces provided. For questions which require units, give your answers in the units stated.

(10 marks)

**All diagrams in this paper are not drawn to scale unless stated otherwise.**

Do not write  
in this space

1. The figure below shows a triangle EFG. It has a perimeter of 84 cm. Find the value of  $p$ .

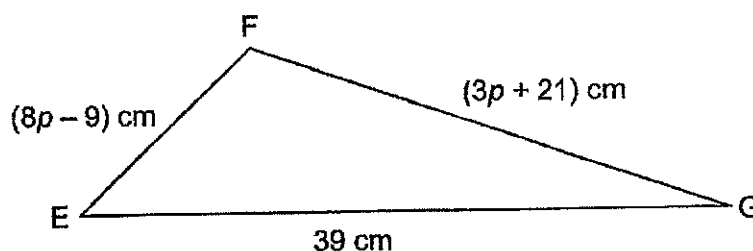

Ans: \_\_\_\_\_

2. Mdm Rosnah needs some pieces of ribbons, each of length 36 cm, to tie gift bags for a party. She bought 3 rolls of ribbon. Each roll is 15 m long. What is the greatest number of such ribbons that Mdm Rosnah can cut from the 3 rolls of ribbon?

Ans: \_\_\_\_\_

3. Chairs are arranged in straight rows in a hall. There are 42 chairs in each row. Each chair has a length of 0.5 m. Every row is 1.5 m apart from the next row of chairs. There are 1470 chairs altogether. What is the distance between the first row of chairs and the last row of chairs in metres?

Do not write in this space

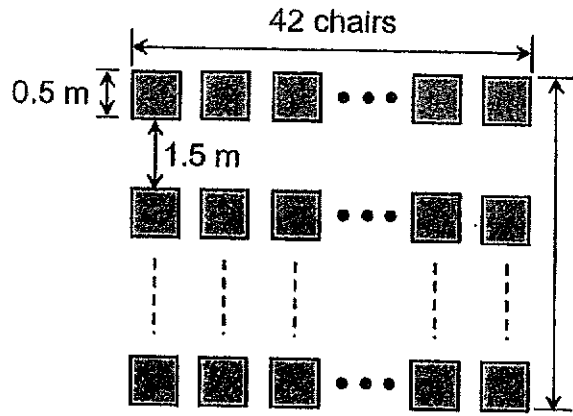

Ans: \_\_\_\_\_ m

4. In the figure below, ADE is an equilateral triangle and ABCD is a square. EH, EC and BH are straight lines. Find  $\angle AFC$ .

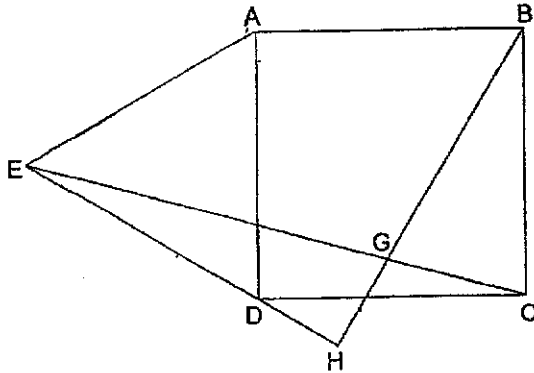

Do not write  
in this space

Ans: \_\_\_\_\_°

5. Dylan and Greg set off from their school at the same time and jogged towards the stadium using the same route. They jogged at a constant speed throughout the whole journey. When Greg covered  $\frac{1}{4}$  of the distance, Dylan was 300 m behind him. Dylan reached the stadium at 9 a.m., jogging at a speed of 100 m/min. What time did Greg reach the stadium?

Ans: \_\_\_\_\_ a.m.

For Questions 6 to 17, show your working clearly in the space provided for each question and write your answers in the spaces provided. The number of marks available is shown in brackets [ ] at the end of each question or part-question. For questions which require units, give your answers in the units stated.  
(45 marks)

Do not write  
in this space

6. Mr Tan had a total of 1370 oranges and pears at first. He sold  $\frac{4}{7}$  of the oranges and 265 pears. The number of oranges left was  $\frac{1}{2}$  the number of pears left. How many more pears than oranges were there at first?

Ans: \_\_\_\_\_ [3]

7.

Don't miss!  
Use this savings  
coupon!

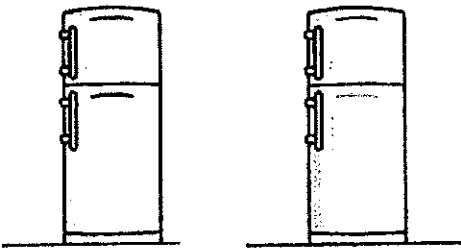

Get the first  
refrigerator at  
10% discount.

Get the second  
one at 20%  
discount!

Do not write  
in this space

Mr Raj paid \$3893 for two identical refrigerators using the savings coupon as shown above. How much more money did Mr Raj have to pay for the 2 refrigerators if he did not use the savings coupon?

Ans: \_\_\_\_\_ [3]

8. Minah saved some \$2-notes and \$5-notes in the ratio of 5 : 3. When she took out 36 \$2-notes and added the same number of \$5-notes, the ratio became 2 : 3. Find the total value of all the \$5-notes Minah saved at first.

Do not write  
in this space

Ans: \_\_\_\_\_ [3]

9. Two rectangular tanks are shown below.

Do not write  
in this space

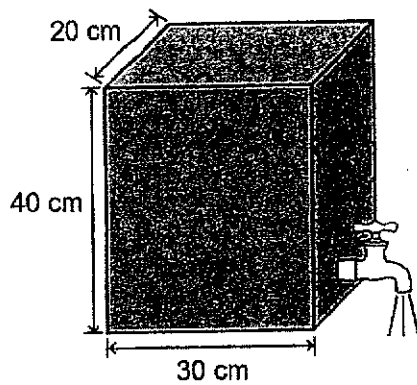

**Tank A**

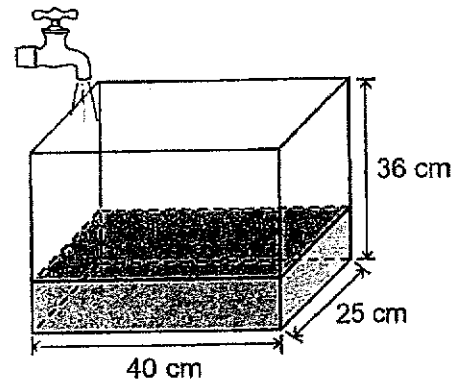

**Tank B**

At first, Tank A was completely filled with water and  $\frac{1}{3}$  of Tank B was filled with water. Water flowed out of the tap at Tank A at a rate of 1.2 litres per minute. Water from the tap at Tank B flowed in at a rate of 1.2 litres per minute.

How long did it take for the height of the water to be the same in both tanks?

Ans: \_\_\_\_\_ [3]



10. In the figure below, ABCD is a rhombus. PQ and RS are 2 straight lines.  $\angle BAD = 134^\circ$ ,  $\angle DCS = 15^\circ$  and  $\angle RCP = 106^\circ$ . Find  $\angle CTD$ .

Do not write  
in this space

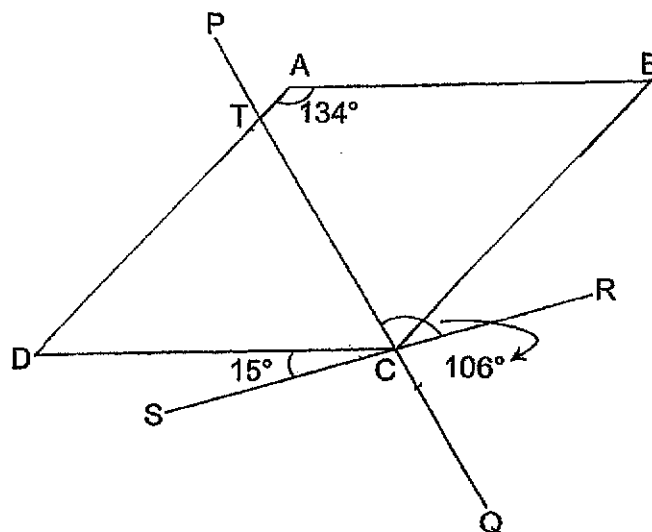

Ans: \_\_\_\_\_ [3]



11. At a charity walkathon, there was an equal number of children who took part in either the 3-km walk or the 5-km walk. There were 208 girls who took part in the 3-km walk and 162 girls who took part in the 5-km walk. 60% of the boys took part in the 5 km walk. For every 1-km walked by the children, \$10 was donated to charity.

Do not write  
in this space

- (a) How many boys took part in the 5-km walk?

Ans: (a) \_\_\_\_\_ [2]

- (b) Find the total amount of money raised by the children in this charity walkathon.

Ans: (b) \_\_\_\_\_ [2]



12. The figure shows a path of width 2 m in a rectangular garden of length 66 m. The outline of the path is made up of quarter circles with centre A, semicircles with centres D and E, and straight lines.  $AB = CD = EF$ .

Do not write  
in this space

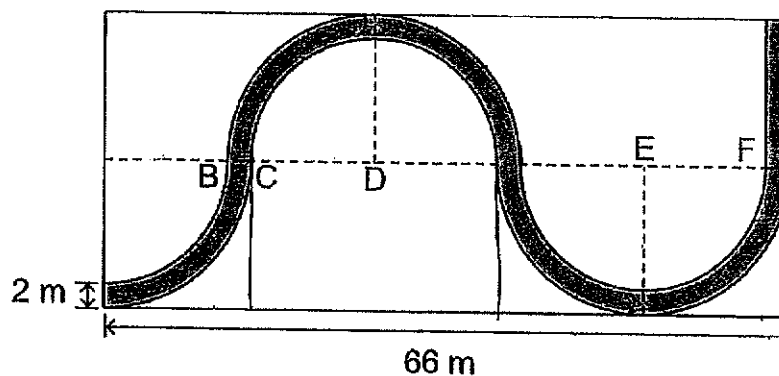

- (a) What is the breadth of the rectangular garden?

Ans: (a) \_\_\_\_\_ [1]

- (b) Find the area of the path. Take  $\pi = 3.14$ .

Ans: (b) \_\_\_\_\_ [3]



13. The graph below shows the rate at which two machines, Machine A and Machine B, were assembling toy cars over a period of 12 hours.

Do not write  
in this space

**Total number of toy cars assembled by Machine A and Machine B**

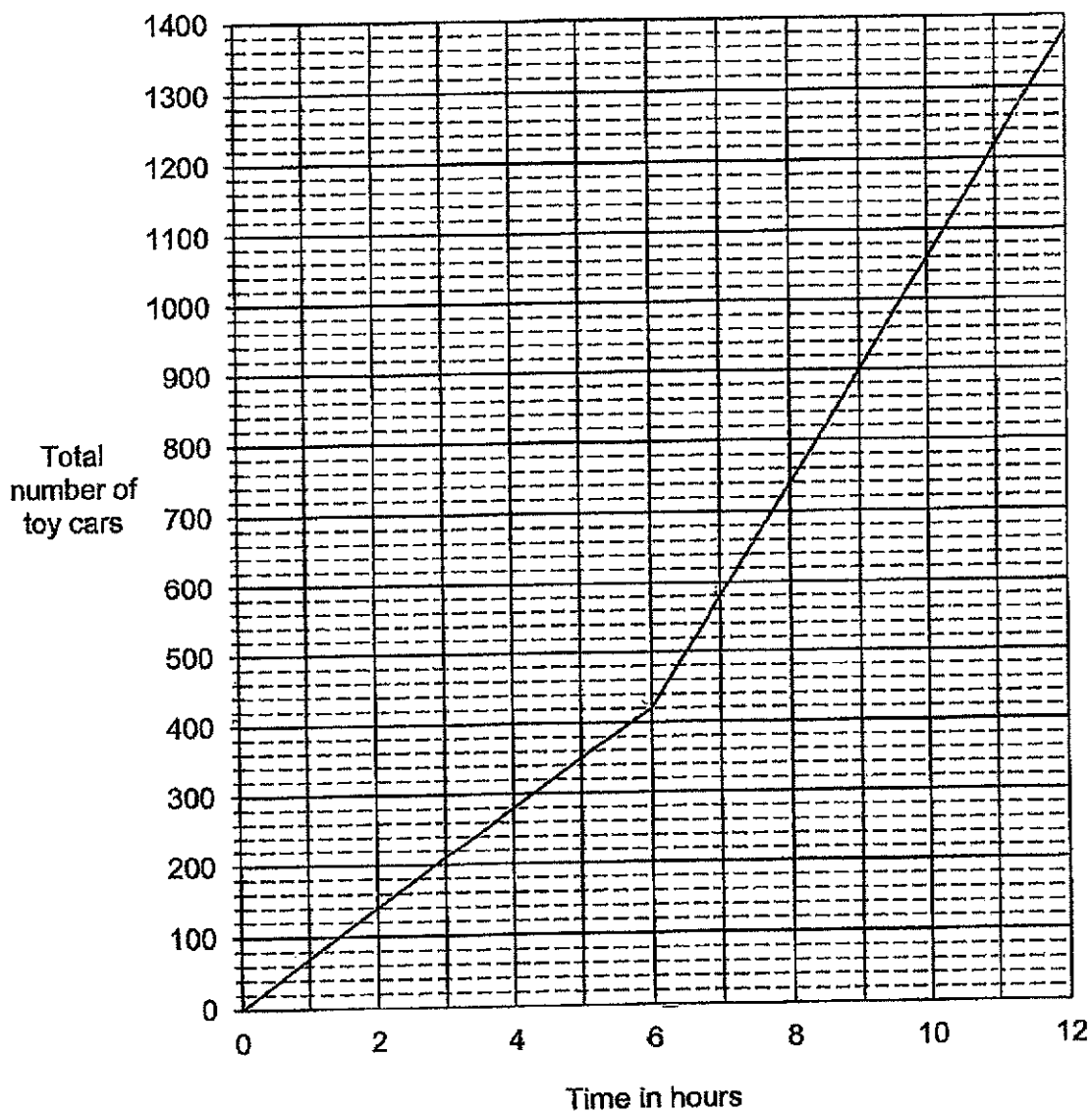

*Continue with parts (a) and (b) on the next page.*

- (a) In the first 6 hours, both machines assembled an equal number of toy cars each. How many toy cars can each machine pack in one hour during this period of time?

Do not write  
in this space

Ans: (a) \_\_\_\_\_ [1]

- (b) During the last 6 hours, the rate at which Machine A was assembling toy cards was increased while Machine B continued assembling toy cars at the same rate. How many more toy cars did Machine A assemble per hour than Machine B during this period of time?

Ans: (b) \_\_\_\_\_ [3]

14. Sherry baked cookies and packed them to sell. The graphs below show the number of cookies she baked and the number of packets of cookies sold from Week 1 to Week 4. Each packet was filled with the same number of cookies.

Do not write in this space

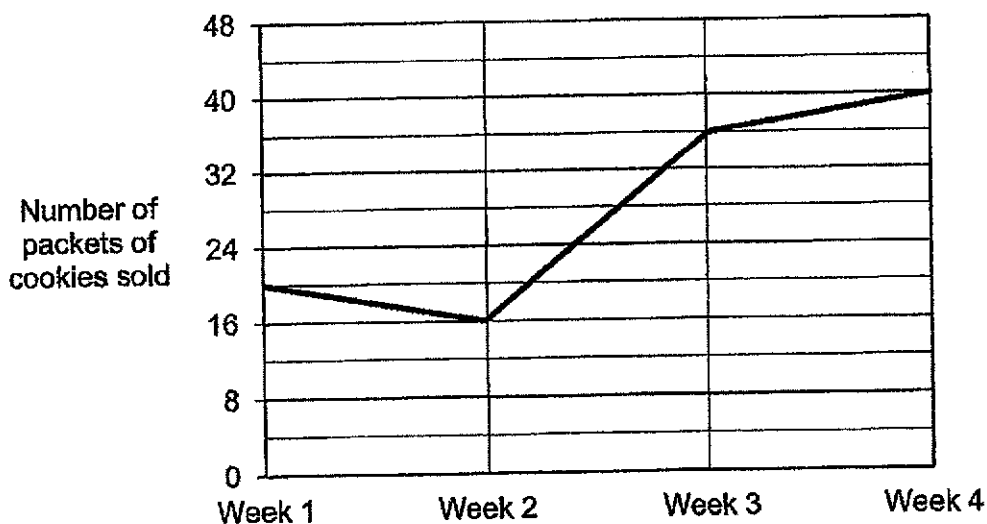
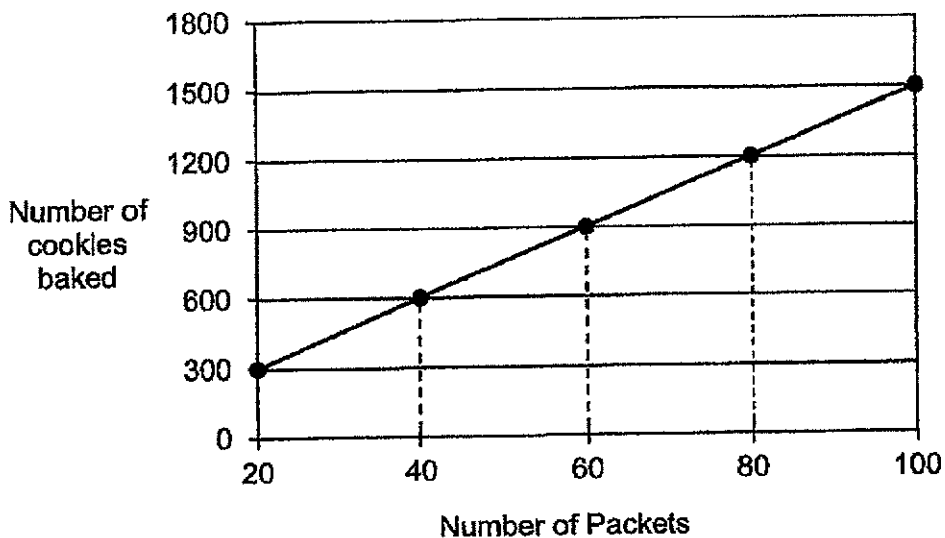

Continue with parts (a), (b) and (c) on the next page.

- (a) How many cookies did she pack in one packet?

Do not write  
in this space

Ans: (a) \_\_\_\_\_ [1]

- (b) How many more packets of cookies did she sell in Week 3 than in Week 1?

Ans: (b) \_\_\_\_\_ [1]

- (c) The number of packets of cookies Sherry sold in Week 5 increased by 30% compared to Week 4. How many cookies did she sell in Week 5?

Ans: (c) \_\_\_\_\_ [2]



15. In the figure below,  $ACE$  is a triangle where  $AF = AB$  and  $EF = ED$ . The sum of  $\angle ABF$  and  $\angle EDF$  is  $125^\circ$ .

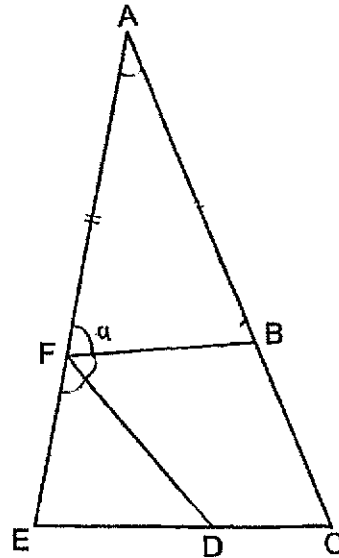

- (a) Find  $\angle BFD$ .

Ans: (a) \_\_\_\_\_ [2]

- (b) Find the sum of  $\angle BAF$  and  $\angle AEC$ .

Ans: (b) \_\_\_\_\_ [2]



Do not write  
in this space

16. The pattern shown below is made up of squares and triangles.

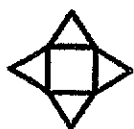

Figure 1

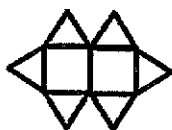

Figure 2



Figure 3



Figure 4

The table below shows the number of squares and triangles for each figure.

Figure Number	Number of squares	Number of triangles	Total number of squares and triangles
1	1	4	5
2	2	6	8
3	3	8	11
4	4	10	14
...	...	...	...
6	6	(a) _____	(a) _____

[1]

- (a) Fill in the table for Figure 6.
- (b) Find the total number of squares and triangles in Figure 102.

Ans: (b) \_\_\_\_\_ [2]

- (c) Find the Figure Number which has a total of 1742 squares and triangles.

Ans: (c) \_\_\_\_\_ [2]

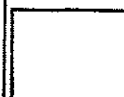

17. Eunice packed 2 types of books into 4 identical shelves. A big book had a thickness of 9 cm while a small book had a thickness of 5 cm, as shown in Figure 1. The 4 shelves, W, X, Y and Z, were stacked on top one another as shown in Figure 2.

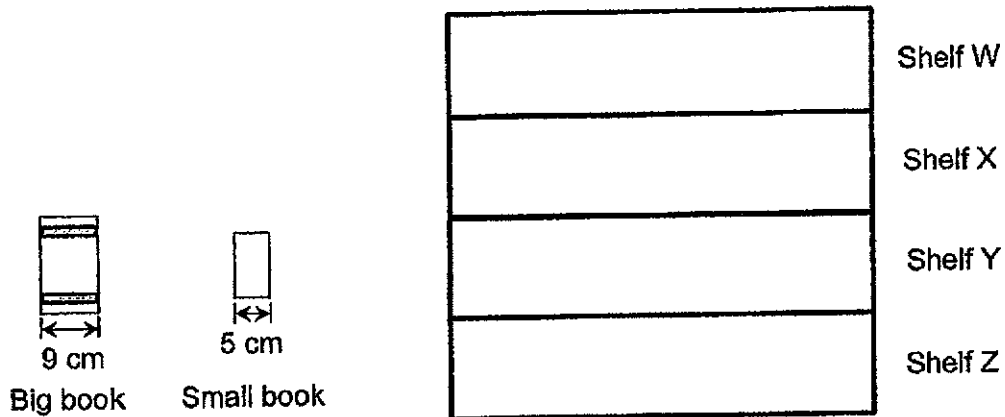

Figure 1

Figure 2

The books were packed next to one another without any gaps. Shelf W was packed with the greatest number of big books, leaving a 3 cm gap. Shelf X was packed from end to end with the greatest number of small books. Figure 3 shows the books in Shelf W and Shelf X.

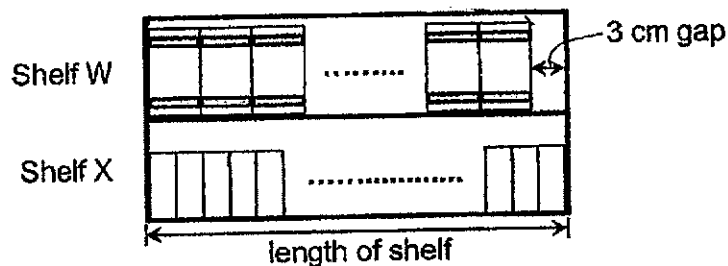

Figure 3

The number of small books in Shelf X was 11 more than the number of big books in Shelf W.

*Continue with parts (a) and (b) on the next page.*

(a) What was the length of Shelf X?

Do not write  
in this space

Ans: (a) \_\_\_\_\_ [3]

Eunice packed a total of 36 big and small books in Shelf Y and Shelf Z. The books were packed from end to end in each shelf without any gaps as shown in Figure 4.

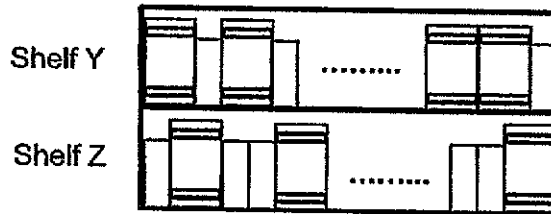

Figure 4

(b) How many big books were packed in Shelf Y and Shelf Z?

Ans: \_\_\_\_\_ [2]



SCHOOL : ROSYTH SCHOOL  
 LEVEL : PRIMARY 6  
 SUBJECT : MATH  
 TERM : 2024 PRELIMS

---

PAPER 1 BOOKLET A

Q1	Q2	Q3	Q4	Q5	Q6	Q7	Q8	Q9	Q10
2	2	2	1	1	3	3	1	4	3

Q11	Q12	Q13	Q14	Q15
3	3	2	4	2

Q16)	$\frac{1}{2} - \frac{1}{8} = \frac{3}{8}$ $\frac{3}{8} \div 2 = \frac{3}{16}$ $\frac{3}{16} + \frac{1}{8} = \frac{5}{16}$
Q17)	$16.2 \div 9 = 1.8\text{kg}$
Q18)	$\sqrt[3]{64} = 4\text{cm}$
Q19)	$\frac{1}{4}$ pupils = 15 + 10 $\frac{1}{2}$ pupils = 50 $50 - 18 = 32$
Q20)	$\angle GAB = \frac{180-52}{2} = 64^\circ$
Q21)	$2 \times 10 = 20$ $20 + 1 = 21$ $21 \times 4 = 84$ $3 \times 2 = 6$ $84 + 6 = 90$



Q27)

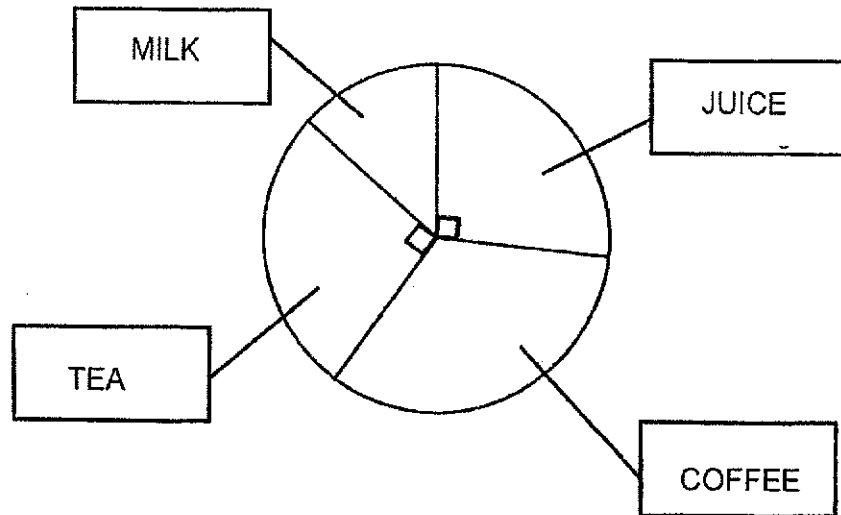

a)

b)  $3u = 84$

$u = 28$

$16u = 448$

Q28)  $2250 \div 2 = 1125$

$1125 - 750 = 375 \text{ cm}^2$

Q29)

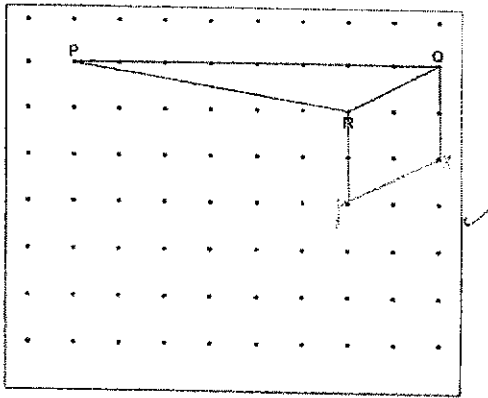

Q30)	a) C b) B
------	--------------

**PAPER 2**

Q1)	$11p + 51 = 84$ $11p = 33$ $p = 3$
Q2)	$1500 \div 36 = 41R24$ $41 \times 3 = 123$
Q3)	$1470 \div 42 = 35$ $35 \times 0.5 = 17.50$ $34 \times 1.5 = 51$ $17.5 + 51 = 68.5$
Q4)	$\angle EDC = 90^\circ + 60^\circ = 150^\circ$ $\angle FED = \frac{180 - 150}{2} = 15^\circ$ $\angle EFD = \angle AFC = 180^\circ - 60^\circ - 15^\circ$ $= 105^\circ$
Q5)	$4(100x + 300) = 400x + 1200$ $1200 \div 100 = 12$ 12min before 9am is <u>8.48am</u>
Q6)	$13u + 265 = 1370$ $13u = 1105$ $u = 85$ $265 - 85 = 180$
Q7)	$90u + 80u = 3893$ $170u = 3893$ $u = 22.9$ $200u = 4580$ $4580 - 3893 = \$687$

Q8)	$15u - 108 = 6u + 72$ $9u = 180$ $u = 20$ $3u = 60$ $60 \times 5 = \$300$
Q9)	$36 \times \frac{1}{3} = 12$ $30 \times 20 = 600$ $40 \times 25 = 1000$ $22.5 - 12 = 10.5$ $10.5 \div 1.2 = 8.75 \text{ mins}$ $600x + 1000x = 24000 + 12000$ $1600x = 36000$ $x = 22.5 \text{ cm}$
Q10)	$\angle PCD = 180^\circ - 106^\circ - 15^\circ$ $= 59^\circ$ $\angle ADC = 180^\circ - 134^\circ$ $= 46^\circ$ $\angle CTD = 180^\circ - 59^\circ - 46^\circ$ $= 75^\circ$
Q11)	<p>a) <math>162 + 60u = 208 + 40u</math></p> $20u = 46$ $u = 23$ $60u = 138$ <p>b) <math>138 + 162 = 300</math></p> $(300 \times 3 \times 10) + (300 \times 5 \times 10) = \$24000$
Q12)	<p>a) <math>5x + 6 = 66</math></p> $5x = 60$ $x = 12$ $2x = 24$ $24 + 4 = 28 \text{ m}$ <p>b) <math>12 + 2 = 14</math></p> $14 \times 14 \times 3.14 \div 4 = 153.86$ $12 \times 12 \times 3.14 \div 4 = 113.04$ $153.86 - 113.04 = 40.82$ $40.82 \times 5 + 2 \times 14 = 232.1 \text{ m}^2$

Q13)	<p>a) <math>420 \div 2 \div 6 = 35</math>  b) <math>1380 - 420 = 960</math>  <math>960 \div 6 = 160</math>  <math>160 - 35 = 125</math>  <math>125 - 35 = 90</math></p>
Q14)	<p>a) <math>300 \div 20 = 15</math>  b) <math>36 - 20 = 16</math>  c) <math>40 \times \frac{13}{10} = 52</math>  <math>52 \times 15 = 780</math></p>
Q15)	<p>a) <math>\angle AFB + \angle DEF = 125^\circ</math>  <math>\angle BFD = 180^\circ - 125^\circ = 55^\circ</math>  b) <math>\angle BAF + \angle AEC = 360^\circ - 125^\circ \times 2 = 110^\circ</math></p>
Q16)	<p>a) <b>No. of Triangles = 14 , Total Squares and Triangles = 20</b>  b) <math>102 \times 3 + 2 = 308</math>  c) <math>n \times 3 + 2 = 1742</math>  <math>3n = 1740</math>  <math>n = 580</math></p>
Q17)	<p>a) <math>9x + 3 = 5(x + 11)</math>  <math>9x + 3 = 5x + 55</math>  <math>4x = 52</math>  <math>x = 13</math>  <math>5(x+11) = 120\text{cm}</math>  b) <math>9y + 5(36-y) = 240</math>  <math>4y + 180 = 240</math>  <math>4y = 60</math>  <math>y = 15</math></p>