



Rosyth School
Term Assessment 2024 (Term 2)

SCIENCE

Primary 6

Total
Marks:

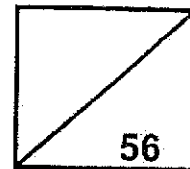

Name: _____

Class: Pr 6 - _____ Register No. _____

Date: 6 May 2024

Duration: Total time for Booklets A and B: 1 h 45 min

Booklet A

Instructions to Pupils:

1. Please do not turn this page until you are told to do so.
2. Follow all instructions carefully.
3. Answer all questions.
4. This paper consists of 2 booklets, Booklet A and Booklet B.
5. For questions 1 to 28 in Booklet A, shade the correct ovals on the Optical Answer Sheet (OAS) provided using a 2B pencil.

This booklet consists of 20 printed pages (including cover page).

For each question from 1 to 28, four options are given. One of them is the correct answer. Make your choice (1, 2, 3 or 4). Write the correct answer in the OAS provided.

(56 Marks)

- 1 The diagram below shows two groups of cells.

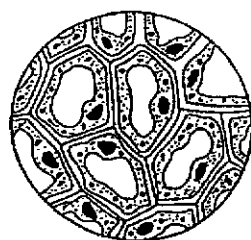

Group K

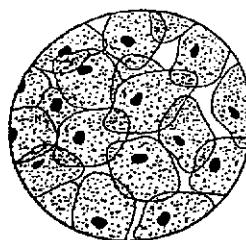

Group L

The table below shows the observations made of the two groups. A tick (✓) indicates that the cell part is present.

Which observation in the table below is correct?

	Cell part	Group K	Group L
(1)	Cell wall	✓	✓
(2)	Cytoplasm	✓	
(3)	Chloroplast		✓
(4)	Cell membrane	✓	✓

- 2 The diagram below shows part of the trunk of a tree with a ring of bark removed. Removing the ring of bark takes away the food-carrying tubes but leaves the water-carrying tubes untouched.

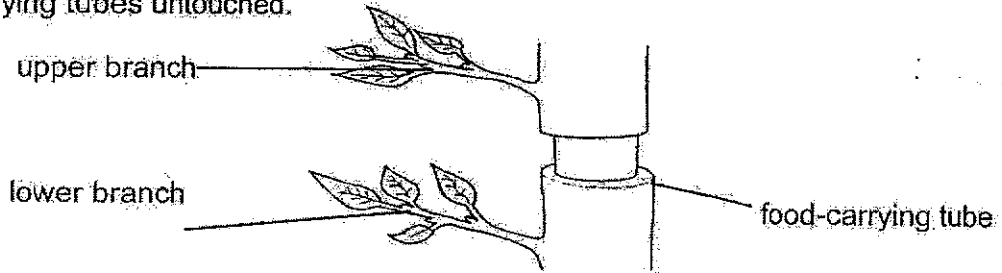

What will be the effect on the two branches?

	upper branch		lower branch	
	growth	leaves	growth	leaves
(1)	normal	normal	normal	normal
(2)	swollen	wilted	normal	normal
(3)	reduced	wilted	reduced	wilted
(4)	normal	normal	normal	wilted

- 3 A group of people was trapped in a lift for 30 minutes as shown below.

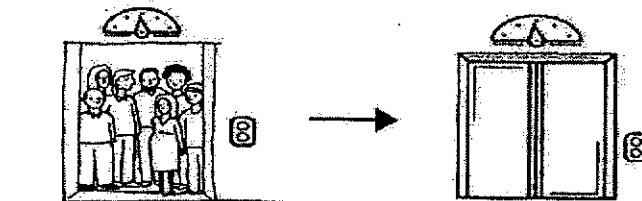

Which one of the following correctly represents the change in the amount of gases in the lift over the 30 minutes?

	Nitrogen	Carbon Dioxide	Oxygen
(1)	increased	decreased	increased
(2)	the same	increased	increased
(3)	the same	increased	decreased
(4)	decreased	increased	decreased

- 4 Four blood samples, A, B, C and D, were collected from different blood vessels in the body. The following graph shows the amount of carbon dioxide in each of the blood samples.

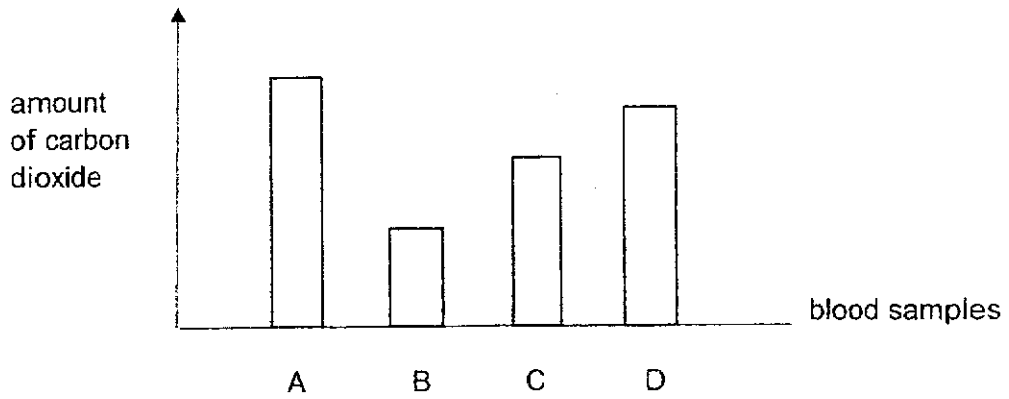

Which one of the blood samples is most likely taken from the blood vessel carrying blood from the heart to the lungs?

- (1) A
 - (2) B
 - (3) C
 - (4) D
- 5 The diagram shows a flower and the male reproductive system.

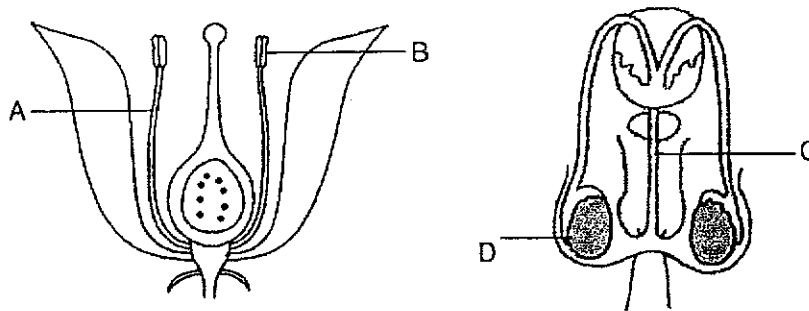

Which parts have the same function?

- (1) A and C
- (2) A and D
- (3) B and C
- (4) B and D

6 The diagrams below show some fruits on a tree and a baby inside a mother's womb.

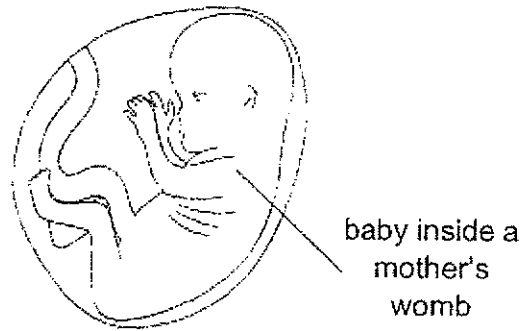
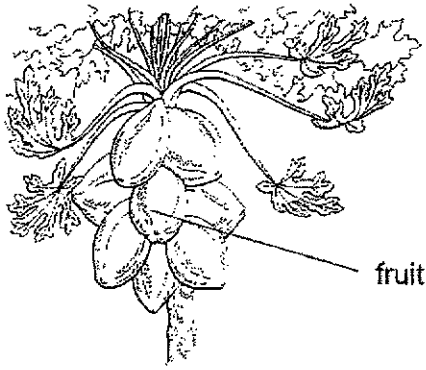

Alex made three statements about the fruit and the baby.

- A It develops into an adult.
- B It developed after fertilisation.
- C It obtains food from its parent for growth.

Which of the following is correct?

	fruit	baby inside a mother's womb
(1)	A,B,C	A,B, C
(2)	A, B	A,B,C
(3)	B,C	A, B,C
(4)	B,C	A, C

7 Why is the sun important to living things?

- (1) The sun is the only source of light.
- (2) The sun is the main source of energy.
- (3) The sun allows living things to make food.
- (4) The sun allows living things to move by themselves.

- 8 The two graphs below show the relationship between the rate of photosynthesis of seaweed and depth of sea water against light intensity.

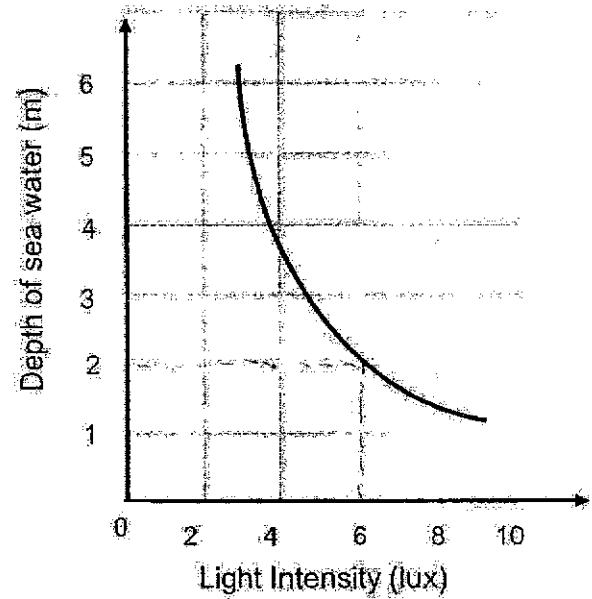
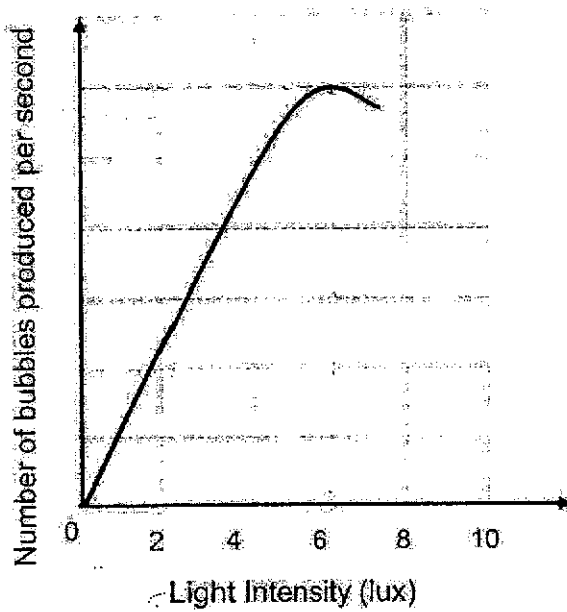

Based on the given graphs, what can be deduced about the seaweeds?

- (1) The greater the light intensity, the higher the rate of photosynthesis.
- (2) The highest rate of photosynthesis of seaweed occurs at a depth of 2m.
- (3) The greater the depth of sea water, the higher the rate of photosynthesis.
- (4) The rate of photosynthesis does not depend on the depth of the sea water.

- 9 Study the incomplete food chain.



Which one of the following is needed to complete the above food chain?

- (1) Sun
 - (2) Prey
 - (3) Producer
 - (4) Consumer
- 10 The diagram shows a grassland habitat.

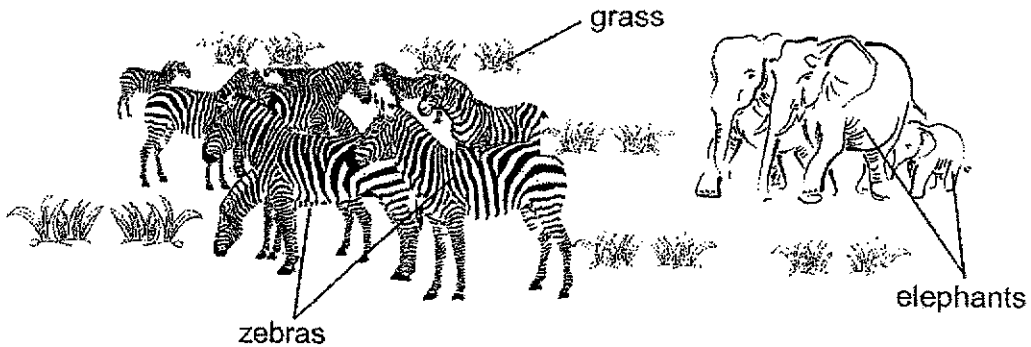

Which one of the statements is not true?

- (1) The group of grass forms one population.
- (2) The group of grass and zebra form two populations.
- (3) The groups of elephant and zebra form two communities.
- (4) The groups of grass, zebra and elephant form one community.

- 11 The letters, A, B and C, below represent organisms in a community and the arrows show the direction of the flow of energy.

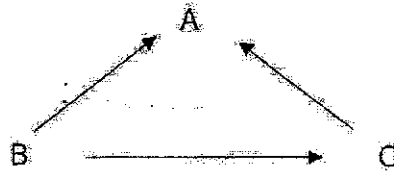

Which of the following correctly represents A, B and C in the community?

	A	B	C
(1)	plants	decomposers	animals
(2)	animals	decomposers	plants
(3)	plants	animals	decomposers
(4)	decomposers	plants	animals

- 12 Seaweeds are plants that live in the sea. An example of a seaweed is shown below.

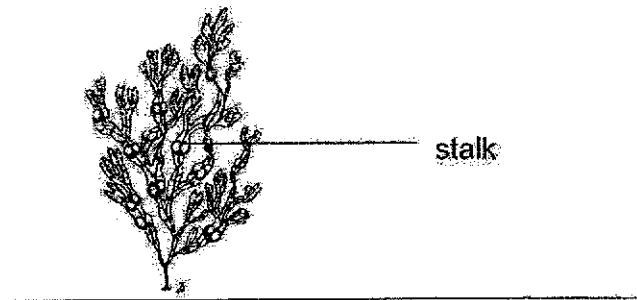

Waves pull the seaweed in different directions and the seaweed is adapted to survive the sea waves.

Which properties of the stalk have helped it to adapt in its environment?

- (1) Elastic and Flexible
- (2) Flexible and Strong
- (3) Elastic and Strong
- (4) Elastic and Waterproof

- 13 Angie wanted to find out how a certain factor will affect the growth of goldfish. She listed the following factors.

W: Amount of food

X: Size of fish tank

Y: Number of goldfish

Z: Temperature of surrounding

She proposed several experiments which she would like to conduct in the table below.

Which one of the following is possible to find out the effect of a certain factor on the growth of goldfish?

	aim of the experiment	variables kept constant
(1)	To find out if the size of the fish tank affects the growth of the goldfish.	W, X and Z only
(2)	To find out if temperature of water affects the growth of the goldfish.	W, X and Y only
(3)	To find out if overcrowding affects the growth of the goldfish.	W, X and Y only
(4)	To find out if the amount of food given affects the growth of the goldfish.	X and Z only

- 14 Which of the following examples of adaptations have been correctly classified as behavioural and structural respectively?

	Behavioural Adaptation	Structural Adaptation
(1)	Animals in desert search for food at night to avoid the heat from the sun.	Animals in desert hide in the shade to avoid the heat from the sun.
(2)	Some birds have colourful large feathers to attract mates.	Some birds dance to attract mates.
(3)	Predators have sharp teeth to tear the flesh of prey.	Predators usually hunt in groups to catch a prey that is larger.
(4)	Some insects pretend to be dead to prevent predators from attacking.	Some insects have toxic spines to kill the predators.

15 Why are there more totally submerged water plants found just below the surface of water in the pond than at the bottom of the pond?

- (1) They can take in more oxygen from the air.
- (2) They can get more light for photosynthesis.
- (3) They can get more space to prevent overcrowding.
- (4) They can provide more shade for the animals in the pond.

16 The picture below shows a water lily in a lake.

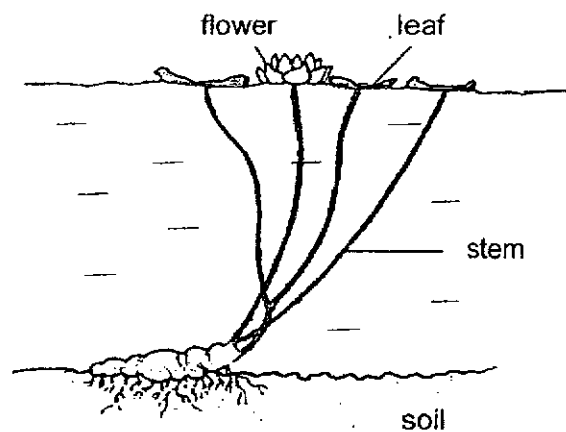

Water lily has adaptations to survive in its habitat. Which of the following is not an adaptation needed for its survival in a lake?

- (1) Deep roots to absorb more water from the soil.
- (2) Flexible stems to withstand the movements of water.
- (3) Dark green leaves on the upper side to trap maximum sunlight.
- (4) More stomata on the upper side of the leaves for gaseous exchange.

- 17 Turtles live in the sea. They lay their eggs on sandy beaches.

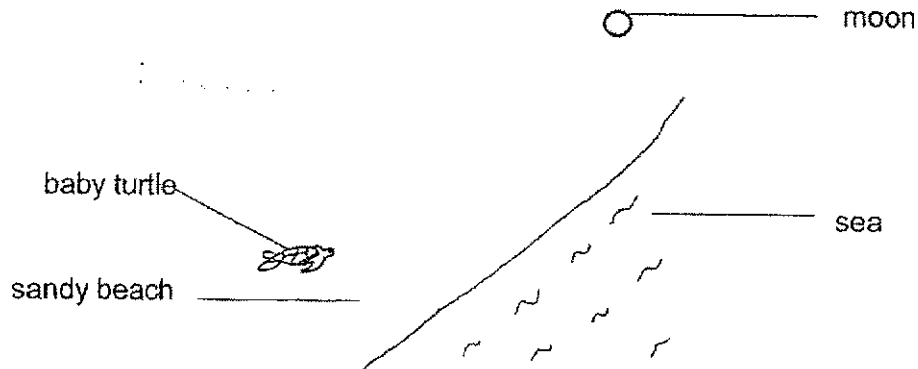

An investigation was carried out to study the effect of beach litter on the crawl time required for baby turtles to reach the sea. The time that baby turtles required to crawl in different amount of litter (low, medium, high, and a control situation) was recorded.

The results showed that amount of litter increased the crawl time of the baby turtles compared to the control situation. It was also observed that as the amount of litter increased, the amount of crawl time increased.

Which one shows the most possible results for the above conclusion?

(1)

Amount of litter	Crawl time (min)
Low	11.8
Medium	11.8
High	14.1
Zero	10.6

(2)

Amount of litter	Crawl time (min)
Low	11.4
Medium	12.0
High	15.8
Zero	10.6

(3)

Amount of litter	Crawl time (min)
Low	14.0
Medium	12.0
High	15.8
Zero	10.6

(4)

Amount of litter	Crawl time (min)
Low	10.5
Medium	13.0
High	17.1
Zero	20.8

- 18 A butterfly has laid several eggs on a leaf which has no other eggs laid by other butterflies. A caterpillar hatched after a week.

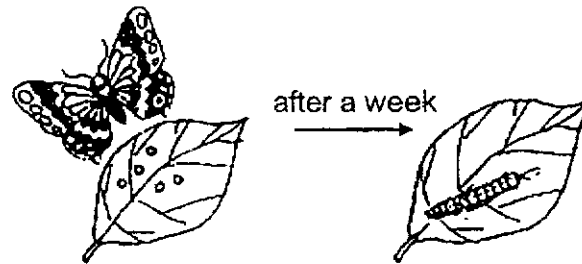

The diagram below shows the leaves of a plant with tiny dots which look like the eggs of a butterfly.

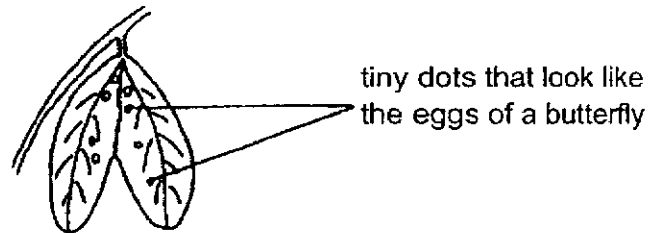

Based on the information, the butterflies will not lay their eggs on these leaves to prevent _____.

- (1) the competition for food for the eggs
- (2) the competition for food for the caterpillar
- (3) the number of eggs eaten by other animals
- (4) the number of eggs affected by the tiny dots

19 The diagram below shows a food web in a community.

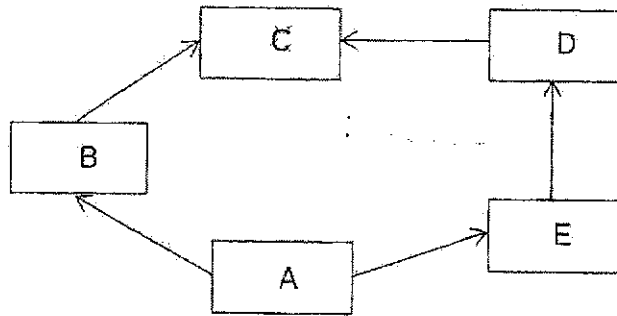

Which of the following graphs shows how the populations of organisms A, B, and D are affected if organism C migrates to another place?

(1)

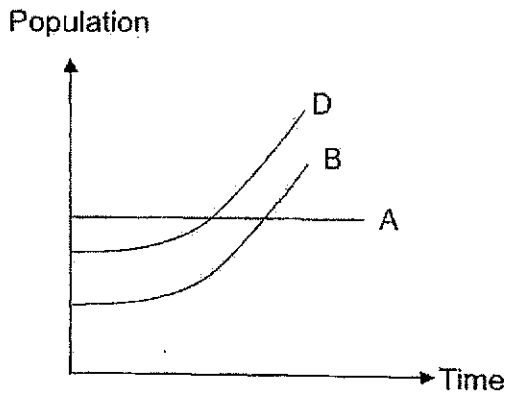

(2)

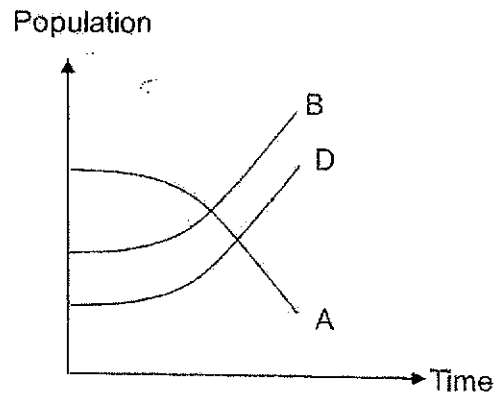

(3)

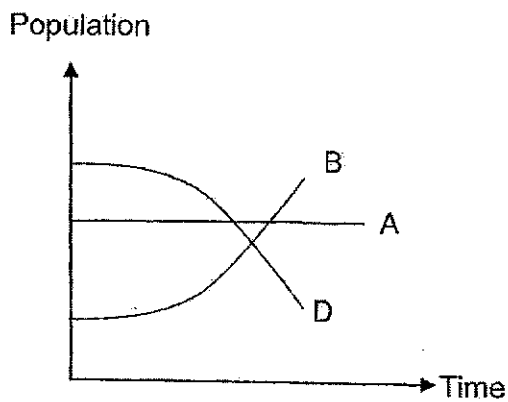

(4)

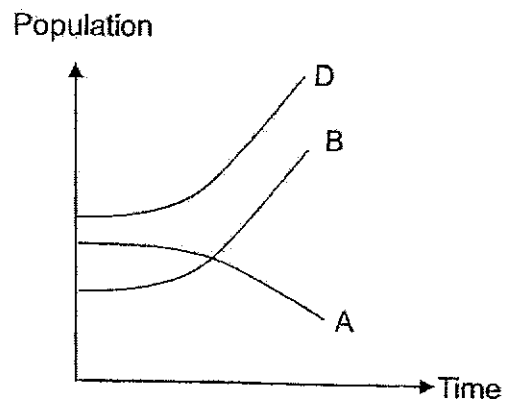

20 The diagram below shows a brownish-green stick insect. It feeds on leaves and is commonly seen on tree branches.

When spotted by a predator, it spreads the brightly-coloured wings and flies away. Once it lands on a branch, it closes its wings and stays very still. Its predator is left wondering where the brightly-coloured prey has disappeared to.

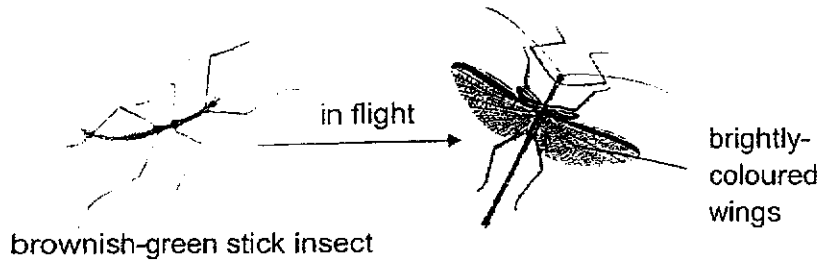

The chart below shows the classification of the adaptations stated above.

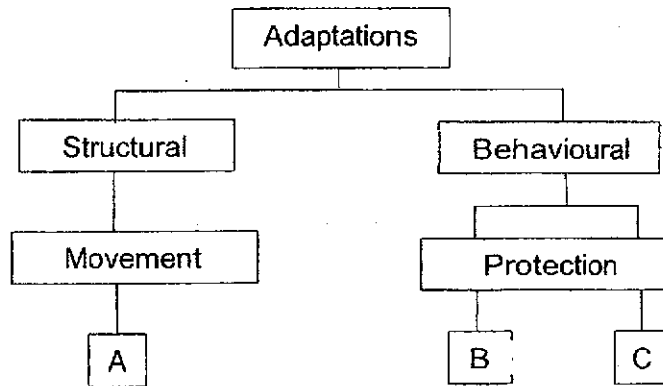

Which of the following correctly represents A, B and C?

	A	B	C
(1)	has brightly-coloured wings	rests on tree branches	brownish-green body
(2)	body that looks like sticks	brownish-green body	closes its wings and stays very still
(3)	closes its wings and stays very still	rests on tree branches	body that looks like sticks
(4)	has brightly-coloured wings	closes its wings and stays very still	rests on tree branches

- 21 Material W was connected in the electrical circuit shown below.

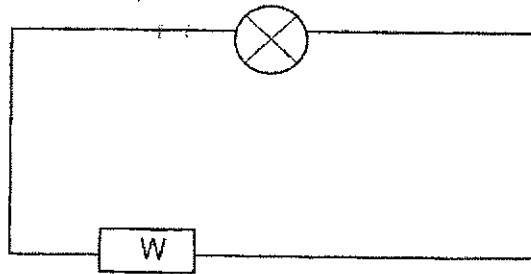

Which one of the following material correctly represents W such that the bulb will not light up?

- (1) iron
 - (2) glass
 - (3) copper
 - (4) aluminium
- 22 A circuit as shown below is connected to three bulbs, two batteries and three switches, A, B and C.

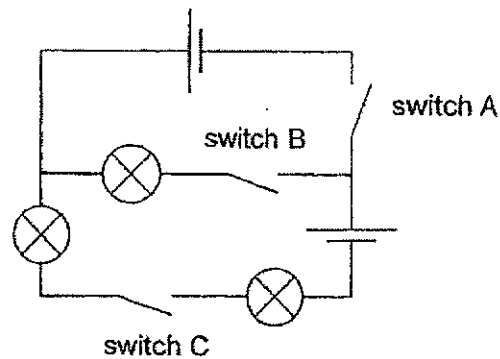

Which of the following will light up only one bulb?

	Switch A	Switch B	Switch C
(1)	Closed	Closed	Open
(2)	Closed	Open	Closed
(3)	Open	Closed	Open
(4)	Open	Open	Closed

- 23 Emily studied the electrical circuit of a fan and wanted to recreate the circuit. However, he did not have the required parts for the circuit and he created a modified electrical circuit for a fan as shown below.

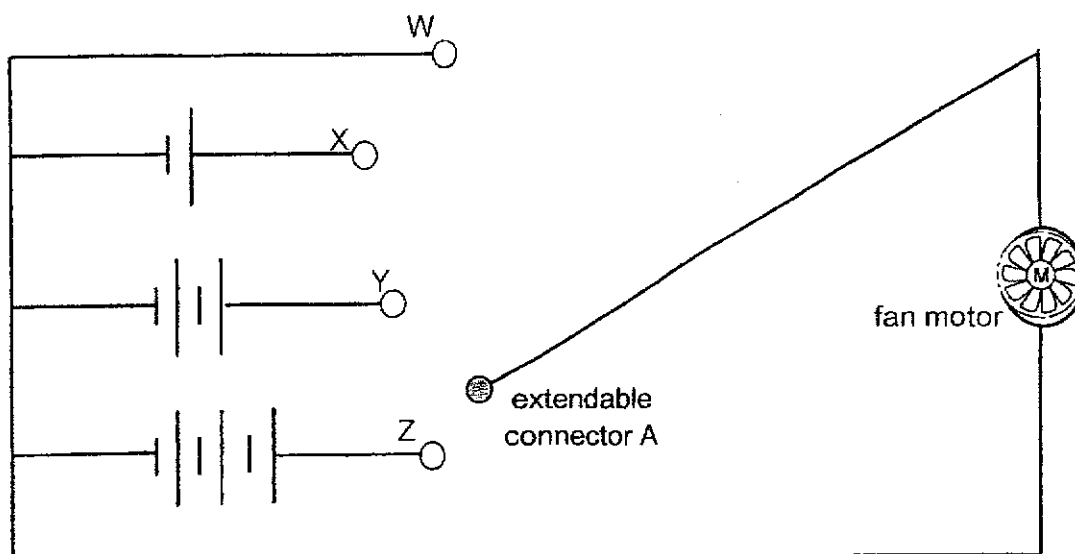

Connector A can be extended to reach all four points, W, X, Y and Z. When connector A is placed at one of the points, W, X, Y or Z, an observation can be made.

Which of the following conclusions can be correctly made from the observation of the electrical set-up above?

- (1) The fan will not work as the circuit is always open.
- (2) The fan is switched on for all connections made to points W, X, Y and Z.
- (3) As the number of batteries increases, the speed of the fan remains the same.
- (4) The speed of the fan can be controlled by switching connections made to points X, Y and Z.

- 24 The diagram below shows the changes in properties of water when there is a change in state.

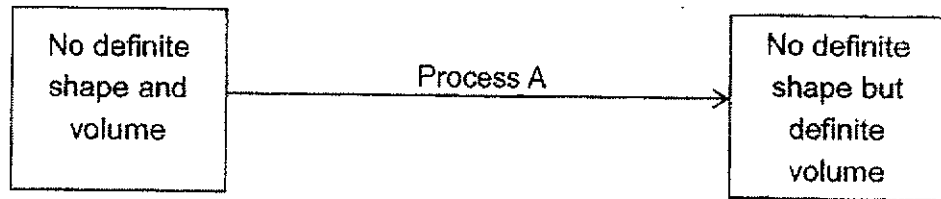

Which one of the following represents process A?

- (1) boiling
 - (2) melting
 - (3) evaporation
 - (4) condensation
- 25 David wanted to find out how different exposed surface area would affect the rate of evaporation of water.

David placed three containers of 100 ml of water in the same room under the same conditions as shown in the diagram below.

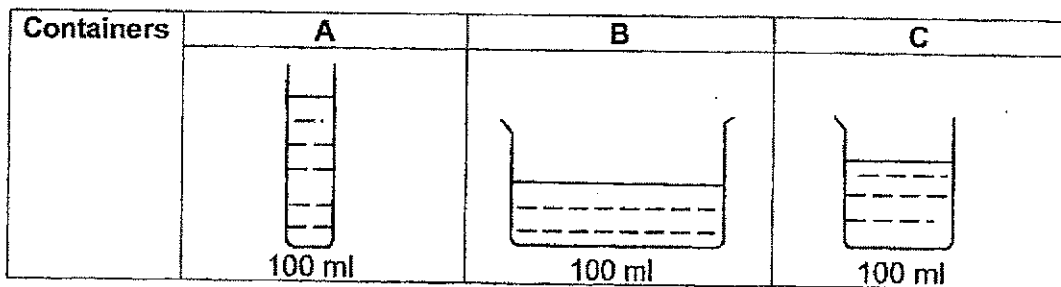

David measured the volume of water left in the containers at the end of his experiment.

Which of the following shows the correct order of volume of water left in the containers?

	Lowest volume of water left	Highest volume of water left
(1)	B	A
(2)	C	A
(3)	B	C
(4)	C	B

- 26 Diana was driving and observed that the inner surface of her car's windscreen has lots of water droplets.

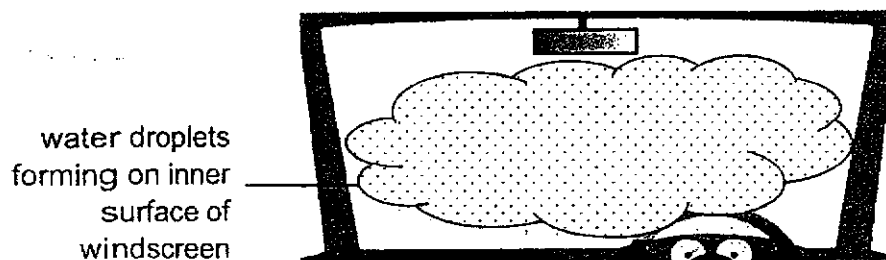

Which is the most possible temperature of air outside and inside the car that could form the most water droplets?

	Temperature outside the car (°C)	Temperature inside the car (°C)
(1)	16	17
(2)	28	16
(3)	16	29
(4)	29	29

- 27 Two objects, D and E of 2kg each, are hung on two springs, X and Y, as shown below.

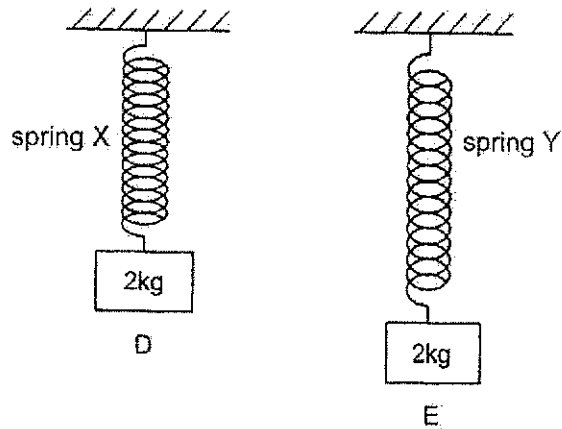

Which of the statements is true?

- (1) There is less gravitational force acting on object E than object D.
- (2) There is more gravitational force acting on object E than object D.
- (3) Spring Y will not return to its original length when object E is removed.
- (4) More force is needed to extend spring X to the same length as spring Y.

28. Miriam set up an experiment using two identical bar magnets, G and H. Magnet G is hanging on a spring balance and magnet H is placed on a weighing scale. The readings on both spring balance and weighing scale is shown in the table below.

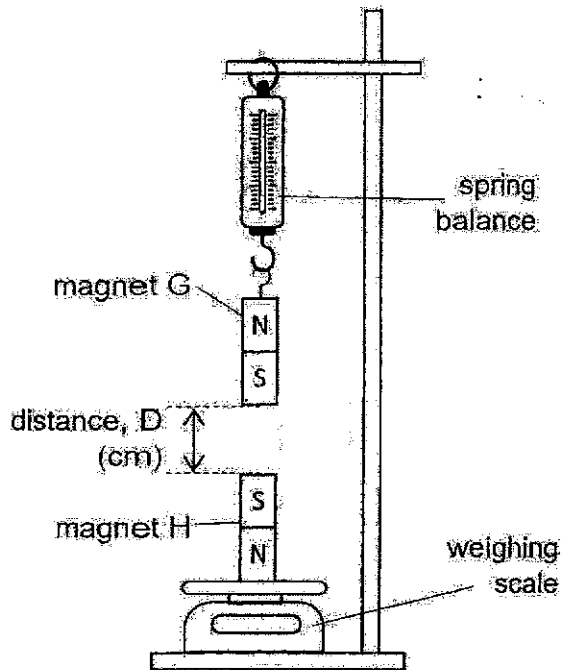

Reading on spring balance (N)	Reading on weighing scale (N)
25	40

Miriam moved the spring balance downwards, which reduced the distance, D. Which of the following shows the likely readings on the spring balance and weighing scale?

(1)

Reading on spring balance (N)	Reading on weighing scale (N)
25	40

(2)

Reading on spring balance (N)	Reading on weighing scale (N)
20	30

(3)

Reading on spring balance (N)	Reading on weighing scale (N)
30	45

(4)

Reading on spring balance (N)	Reading on weighing scale (N)
20	45

Go to Booklet B



Rosyth School
Term Assessment 2024 (Term 2)
SCIENCE
Primary 6

Name: _____

Total
Marks:

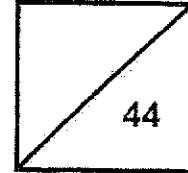

Class: Pr 6-_____ Register No. _____

Date: 6 May 2024

Parent's Signature: _____

Duration: Total time for Booklets A and B: 1 h 45 min

Booklet B

Instructions to Pupils:

1. Please do not turn this page until you are told to do so.
2. Follow all instructions carefully.
3. Answer all questions.
4. Use a dark blue or black ballpoint pen to write your answers in the space provided for each question.
5. Do not use correction fluid/tape or highlighters.

	Maximum	Marks Obtained
Booklet A	56 marks	
Booklet B	44 marks	
Total	100 marks	

* This booklet consists of 15 printed pages (including cover page).

For questions 29 to 40, write your answers in the space provided. **(44 Marks)**

- 29 The table below shows parts of a cell that is present in cells S, T, U and V. A tick (✓) in the box indicates the presence of the characteristic.

parts of a cell	cell S	cell T	cell U	cell V
nucleus		✓	✓	✓
cell wall		✓		✓
cytoplasm	✓	✓	✓	✓
chloroplast		✓		
cell membrane	✓	✓	✓	✓

- (a) All the cells were soaked in four containers of equal amount of water. After sometime, two cells burst while the other two cells remained the same.

Which two cells remained the same? Support your choice. [1]

- (b) What would eventually happen to cell U if the nucleus is removed? [1]

- (c) State one difference between Cell T and Cell U. [1]

Do not write in the margin.

Do not write in the margin.

Do not write in the margin.

30 The diagram below shows a plant.

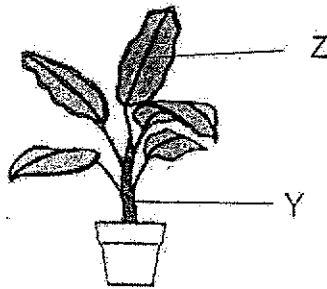

(a) Identify the substance that is transported from Z to the roots. [1]

(b) Besides transporting substances, state another function of Y. [1]

Jill conducted an investigation. She took two similar pots of plants A and B. She put a plastic bag around the pot of plant A as shown below. She tied a string tightly around the plastic bag and the stem. She placed them at the same place and watered only the leaves of both plants.

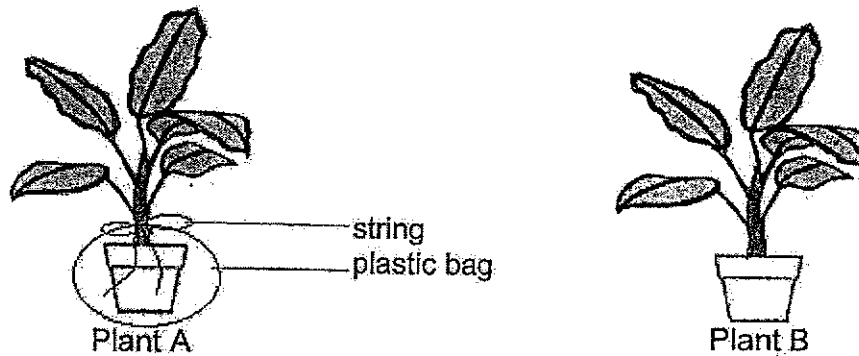

(c) Plant A died but Plant B did not. Explain why Plant B did not die. [1]

(d) What is the purpose of Plant B in the experiment? [1]

Do not write in the margin.

Do not write in the margin.

Do not write in the margin.

- 31 The graph below shows how Claire's heart rate changes as she exercises on a treadmill.

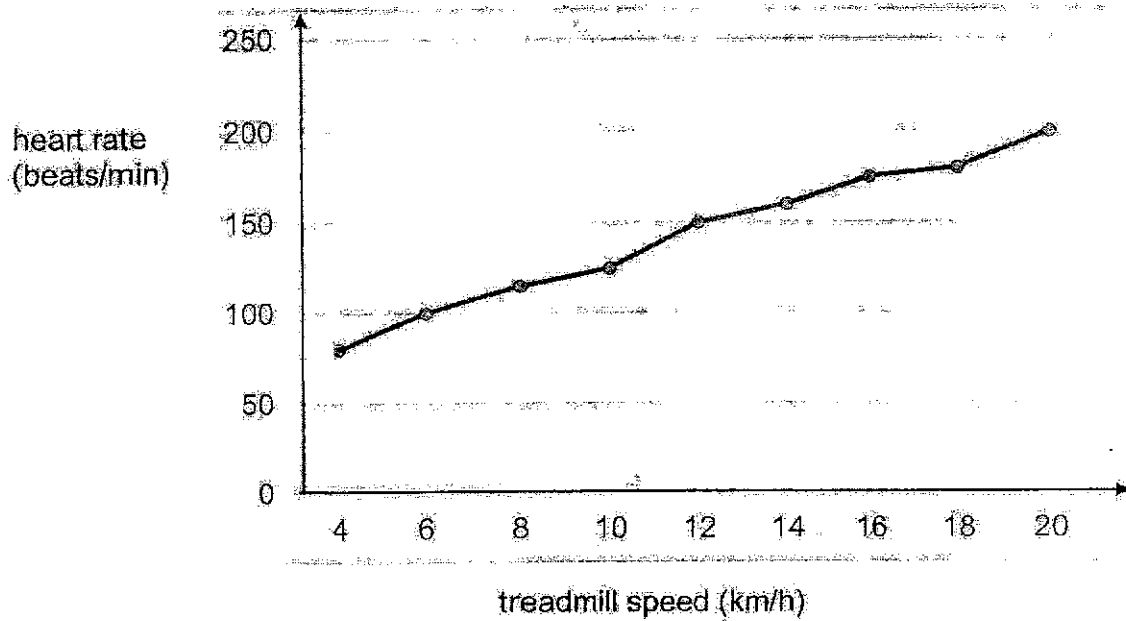

- (a) What is the relationship between the treadmill speed and the heart rate? [1]

- (b) Besides the heart, name two other parts in the human circulatory system. [1]

(i) _____

(ii) _____

- (c) Based on the graph, Claire made the following inference.

"The heart beats faster during an exercise to supply the body with more blood".

Do you agree with Claire? Explain why. [2]

Do not write in the margin.

32 Study the diagram below.

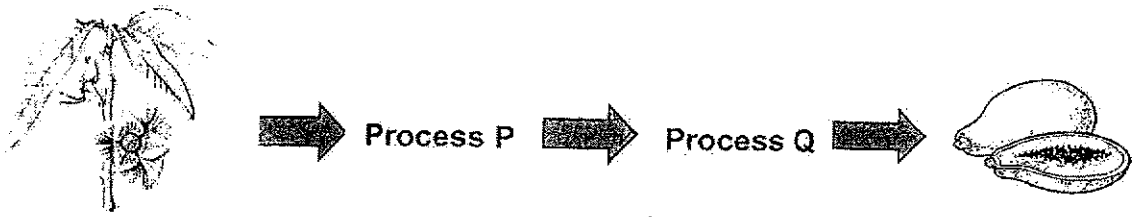

(a) Describe Process P.

[1]

The diagram below shows parent plants, X and Y, and their dispersal patterns.

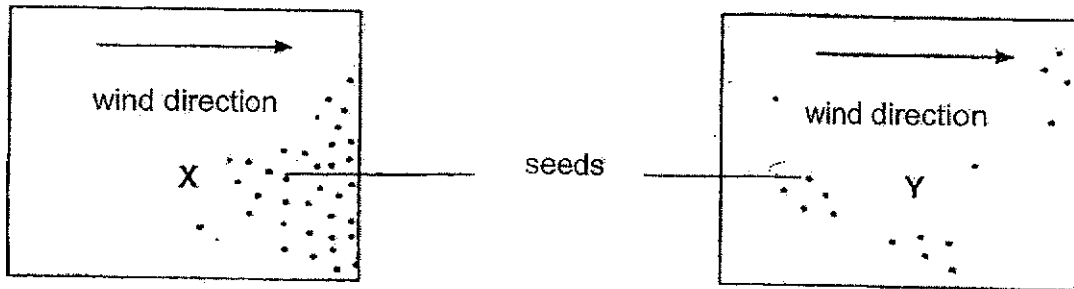

An unknown fruit with stiff hairs was found.

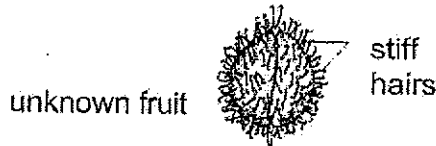

(b) Which plant, X or Y, could be the parent plant of the unknown fruit? Explain your answer.

[2]

(c) Explain why it is important for plants to disperse their seeds.

[1]

Do not write in the margin.

Do not write in the margin.

Do not write in the margin.

33 A group of students conducted an experiment using two identical tubes as shown. They put the two set-ups, A and B, in the sun for a few hours.

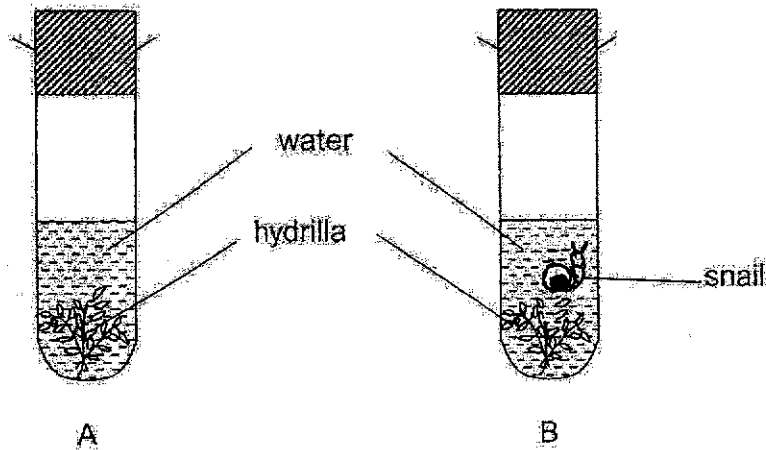

After a few hours, a drop of red indicator was added to each tube. When the red indicator was added, the colour of water changed according to the amount of carbon dioxide present.

The colour of water indicates the amount of carbon dioxide present as shown below.



Do not write in the margin.

Do not write in the margin.

(a) In which set-up would the colour of indicator more likely to turn purple? Explain your choice of answer. [1]

(b) Other than what is observed from the experiment above, state one way in which animals benefit from plants in a pond. [1]

Do not write in the margin.

34 The diagram below shows animal K.



Animal K is found in country M that experiences short period of hot season and long period of cold season. It flies to country N during the period of cold season to look for food.

- (a) Name two characteristics of living things that are shown by this behaviour of animal K. [2]

Characteristic 1: _____

Characteristic 2: _____

- (b) Other than competing for food, suggest two possible ways in which animal K can be harmful to other animals living in country N. [2]

Do not write in the margin.

Do not write in the margin.

Do not write in the margin.

35 Study the Animal X shown below:

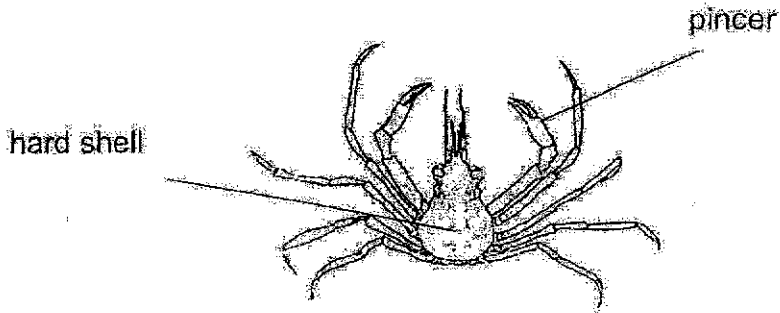

(a) Animal X has a pair of pincers and a hard shell. Explain how these physical features would benefit it.

[2]

(i) pincers:

(ii) hard shell:

(b) Animal X 'decorates' itself in the sea using water plants as shown below.

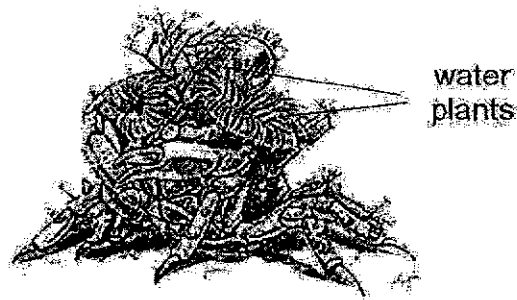

Explain why animal X needs to 'decorate' itself with water plants.

[1]

Do not write in the margin.

Do not write in the margin.

Question 35 continues on the next page

Do not write in the margin.

(c) Animal Z is small and it grows on animal X.

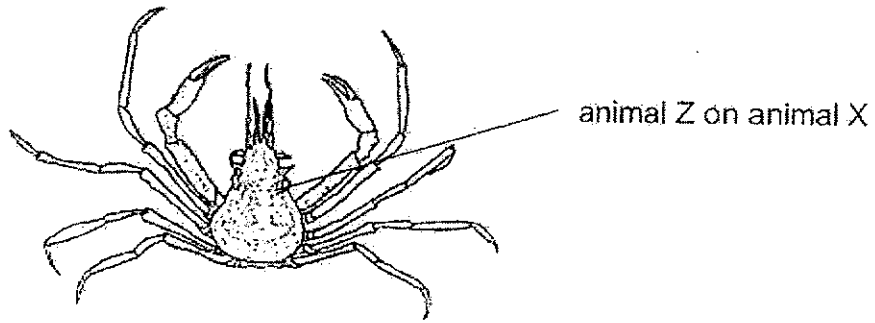

Explain why it is an advantage to grow on animal X.

[1]

Do not write in the margin.

Do not write in the margin.

Do not write in the margin.

36 Study the food web below.

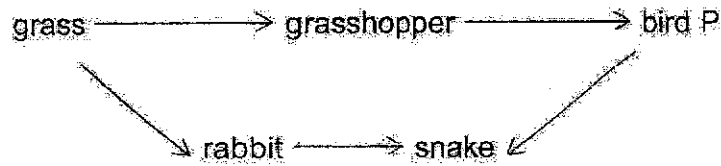

(a) Identify one food chain from the above food web. [1]

(b) Explain why grass is important to all the organisms in the above food web. [2]

(c) A population of bird Q was introduced into the habitat. James said that due to this introduction, the bird P population will decrease while John said that bird P population will increase.

(i) Explain how it is possible for James to be correct. [1]

(ii) Explain how it is possible for John to be correct. [1]

Do not write in the margin.

Do not write in the margin.

Do not write in the margin.

- 37 Farah used sensors to measure the light intensity and temperature of air in two different habitats, garden and open field. She recorded the readings in the table as shown below.

habitat	light intensity (lux)				temperature of air (°C)			
	8 am	11 am	2 pm	5 pm	8 am	11 am	2 pm	5 pm
garden	1345	2006	2879	1389	30	32	33	29
open field	1552	2881	3356	1775	31	33	34	30

- (a) Based on the data above, describe how the temperature of air is affected by light intensity. [1]

- (b) Name two other physical factors that can affect the temperature of air in the two habitats. [2]

(i)

(ii)

Do not write in the margin.

Do not write in the margin.

Do not write in the margin.

- 38 Mary set up a circuit using two bulbs and a battery.
She wants the following condition to be met.

There are two pathways for the electrical current to flow.

- (a) Complete the circuit below.

[2]

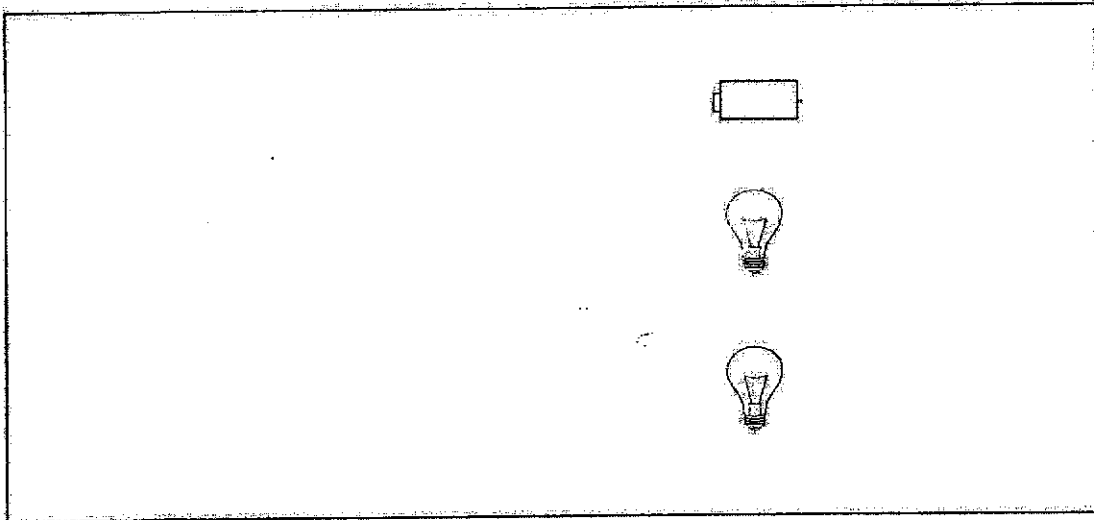

- (b) State one disadvantage of the above circuit.

[1]

- (c) Suggest how the two bulbs can be controlled independently.

[1]

Do not write in the margin.

Do not write in the margin.

Do not write in the margin.

39 The figure below shows a beaker of water.

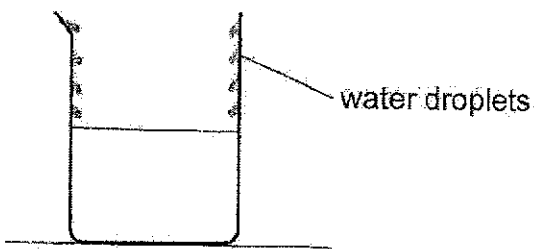

(a) Based on the observation of water droplets, does the beaker contain hot or cold water? Explain your choice. [2]

(b) After two hours, the water droplets on the beaker disappeared. Explain what happened. [1]

Do not write in the margin.

Do not write in the margin.

Do not write in the margin.

40. Graph 1 shows how the increase in length of two springs, P and Q, changed when loads were hung from them.

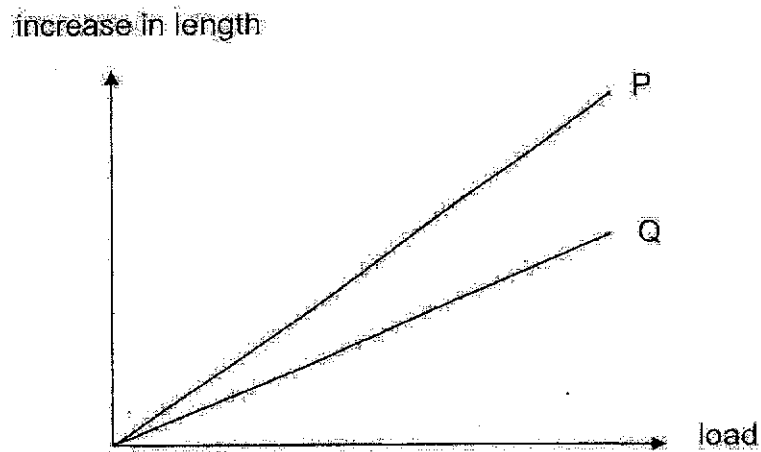

Graph 1

- (a) Based on Graph 1, which spring, P or Q, can be stretched more easily? Give a reason for your answer. [1]

- (b) State the effect of force in the above experiment. [1]

Do not write in the margin.

Do not write in the margin.

Question 40 continues on the next page

Do not write in the margin.

Teck Yong conducted an experiment using a different spring, R. He hung a 5 g load from R and measured the increase in the length of R. He repeated the experiment by adding a 5 g load, one at a time, until the total load was 25 g.

Next, Teck Yong started to remove a 5 g load, one at a time, until there was no more load left. Graph 2 shows his results.

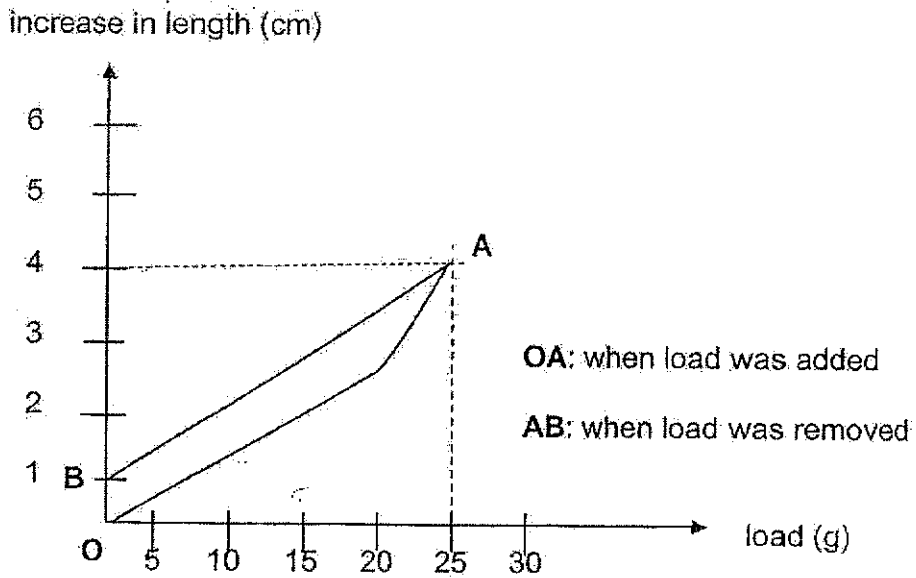

Graph 2

Do not write in the margin.

Do not write in the margin.

- (c) If the original length of the spring was 3cm, what was its length when there was no more load left? Give a reason for your answer. [2]

End of Paper

Do not write in the margin.

SCHOOL : ROSYTH PRIMARY SCHOOL
 LEVEL : PRIMARY 6
 SUBJECT : SCIENCE
 TERM : 2024 WA2

Q1	Q2	Q3	Q4	Q5	Q6	Q7	Q8	Q9	Q10
4	1	3	1	4	3	2	2	3	3
Q11	Q12	Q13	Q14	Q15	Q16	Q17	Q18	Q19	Q20
4	2	2	4	2	1	2	2	2	4
Q21	Q22	Q23	Q24	Q25	Q26	Q27	Q28		
2	1	4	4	1	3	4	4		

SCHOOL : ROSYTH SCHOOL
LEVEL : PRIMARY 6
SUBJECT : SCIENCE
TERM : 2024 WA2

SECTION B

Q29a)	Cell T and V. Both cells have a cell wall, which provides the cells with support and gives them a regular shape.
Q29b)	The cell will die.
Q29c)	Cell T has a cell wall but Cell U does not have a cell wall.
Q30a)	Sugar.
Q30b)	Y holds the plant upright.
Q30c)	When Jill watered the leaves, the water would drip into the soil and be absorbed by the roots, which is then transported to all parts of the plant.
Q30d)	To act as a control to compare and confirm that any difference in the survival of the plants is only due to water taken in by the plant.
Q31a)	As the speed of the treadmill increases, the heart rate increases.
Q31b)	Blood, blood vessels
Q31c)	No. The amount of blood in the body remains the same. During exercise, the body requires more energy. The heart beats faster to transport more digested food and oxygen to our bodies to release more energy, while transporting more carbon dioxide for removal.
Q32a)	Process P is the process where the pollen grain is transferred from the anther to the stigma.
Q32b)	Plant Y. The seeds of Y were scattered randomly, suggesting dispersal by animal. The unknown fruit has stiff hairs, which allows it to cling onto the fur of animals and be carried far away from the parent plant.
Q32c)	It is to prevent overcrowding and reduce competition for space, sunlight, water and mineral salts so seedling is able to grow healthily.
Q33a)	Set-up A. A has a hydrilla which is able to photosynthesise with sunlight. During photosynthesis, the hydrilla takes in carbon dioxide and gives out oxygen, reducing the amount of carbon dioxide in the set-up.
Q33b)	Animals would have a continuous supply of oxygen which they need for respiration.

Q34a)	1. Living things respond to changes around them. 2. Living things need air, food and water to survive.
Q34b)	Animal K could fight for shelter with other animals of country N. It could also produce sounds that disrupt the mating calls of other animals and prevent them from reproducing.
Q35a)	Pincers: It can grab its food without the food slipping away. Hard shell: Protects it from predators.
Q35b)	It is to camouflage itself from its predators.
Q35c)	Animal Z is able to obtain food more easily.
Q36a)	Grass to rabbit to snake.
Q36b)	Grass is important as it is a food producer and is able to photosynthesise. All other organisms depend on grass for food.
Q36ci)	Bird Q eats grasshoppers, so population of grasshoppers decrease. There is less food for bird P so population of P decreases.
Q36cii)	Bird Q eats snakes, so population of snakes decrease. There are less predators of bird P so population of P decreases.
Q37a)	As the light intensity increases, the temperature of the air increases.
Q37b)	Presence of water/presence of animals.
Q38a)	
Q38b)	The battery will run flat faster.
Q38c)	Add a switch next to each of the bulbs.
Q39a)	Hot water. Hot water in the beaker evaporates to form hot water vapour. The hot water vapour comes into contact with the cooler inner surface of the beaker, loses heat and condenses into tiny water droplets.
Q39b)	The water droplets gained heat and evaporated into the surrounding air.
Q40a)	Spring P. It stretches more with the same load.
Q40b)	The force changed the shape of the spring.

