



**HENRY PARK PRIMARY SCHOOL**  
**2024 PRELIMINARY EXAMINATION**  
**STANDARD SCIENCE**  
**PRIMARY SIX**  
**BOOKLET A**

Name: \_\_\_\_\_ (    )

Class: Primary 6 (    )

**28 QUESTIONS**

**56 MARKS**

**TOTAL TIME FOR BOOKLETS A & B: 1 HOUR 45 MINUTES**

**INSTRUCTIONS TO CANDIDATES**

1. Do not turn over this page until you are told to do so.
2. Follow all instructions carefully.
3. Answer all questions.

Marks for Booklet A: \_\_\_\_\_ / 56

Parent's Signature: \_\_\_\_\_

<b>Sections</b>	<b>Marks</b>
<b>A</b>	/ 56
<b>B</b>	/ 44
<b>Total</b>	/ 100



1

For each question from 1 to 28, four options are given. One of them is the correct answer. Make your choice (1, 2, 3 or 4) and shade your answer on the Optical Answer Sheet.

(56 Marks)

1 The diagram below shows five organisms.



mushroom



fern



fish



bread mould



ant

They can be classified into two groups, X and Y, as shown below.

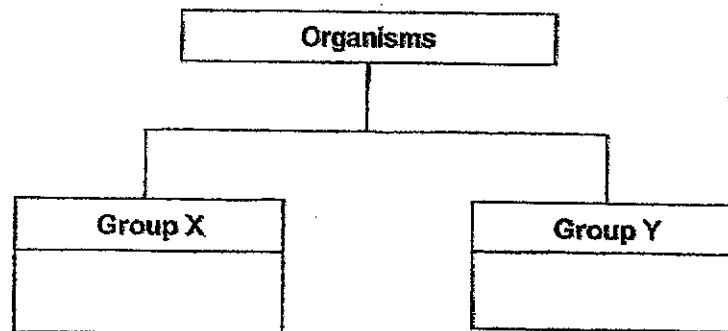

Susan has classified the organisms using different headings for X and Y as shown below.

	Group X	Group Y
P	Reproduce from spores	Do not reproduce from spores
Q	Single-celled	Multi-celled
R	Make its own food	Obtain food from other organisms

Which of the above are suitable ways to classify the organisms?

- (1) P and Q only
- (2) Q and R only
- (3) P and R only
- (4) P, Q and R

2

2 The diagram shows cell Z observed under a microscope.

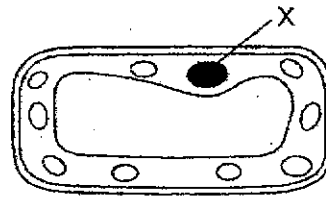

Cell Z

Which of the following statements is correct about part X?

- (1) It supports and gives the organism its shape.
- (2) It controls activities that happen within the cell.
- (3) It contains chlorophyll which traps light to make food.
- (4) It controls the movement of substances in and out of the cell.

3 The diagram below shows two flowers from the same plant.

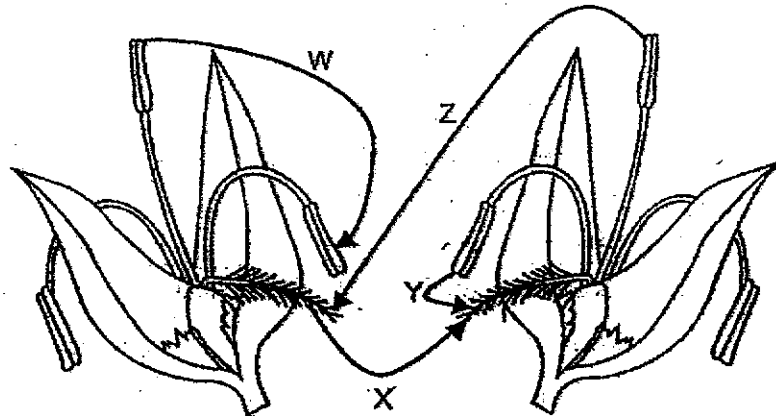

Which of the arrows show(s) pollination taking place?

- (1) Y only
- (2) W and Y only
- (3) X and Z only
- (4) Y and Z only

- 4 Khairul removed an outer ring from a plant as shown below. The food and water carrying tubes have been removed. The plant was watered regularly for two weeks.

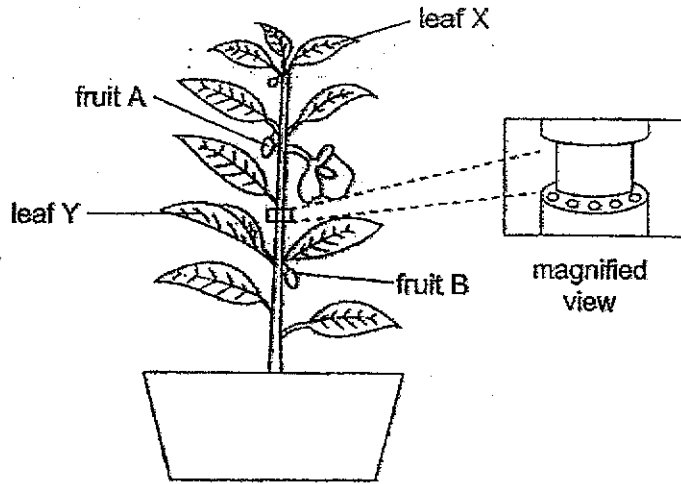

After one week, he observed that fruit B grew bigger than fruit A.

Which one of the following statements best explains his observation?

- (1) Fruit B made its own food.
  - (2) Fruit B absorbed food from the soil.
  - (3) Leaf Y made food which was transported to fruit B.
  - (4) Leaf X made food, but the food was not transported to fruit A.
- 5 The diagram below shows how the circulatory, digestive and respiratory systems in our body work together.

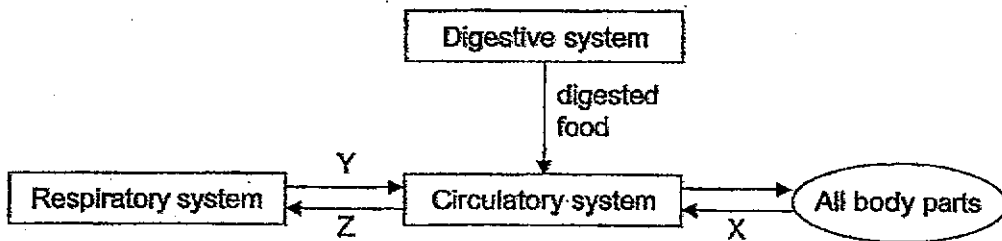

Which of the following correctly shows what X, Y and Z represent?

	X	Y	Z
(1)	oxygen	carbon dioxide	oxygen
(2)	carbon dioxide	oxygen	oxygen
(3)	carbon dioxide	oxygen	carbon dioxide
(4)	oxygen	carbon dioxide	carbon dioxide

- 6 The diagram below shows an experimental set-up to investigate photosynthesis. The plant has leaves which are green in the middle and white around the edges.

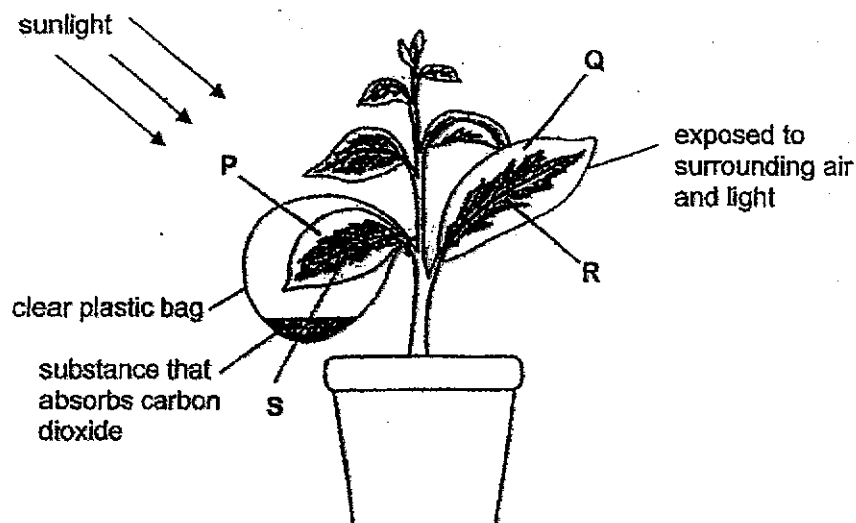

After a few hours, the leaves were removed and tested for the presence of starch. Which of the following shows the correct test results?

Leaf areas where	
starch is present	starch is absent
(1) Q, R	P, S
(2) R, S	P, Q
(3) R	P, Q, S
(4) P, Q, S	R

- 7 The following predator-prey relationships were observed among four organisms P, Q, R and S.

P is eaten by S.  
 P feeds on R.  
 S feeds on R but not Q.  
 R gets its food from Q.

Which one of the following correctly shows the correct classification of the organisms?

	Food producer	Prey	Predator & prey	Predator
(1)	R	Q	S	P
(2)	Q	R	P	S
(3)	S	R	P	Q
(4)	Q	S	R	P

- 8 A few people were trapped in a lift during a blackout which caused the fan in the lift to stop working.

Which of the following shows the correct changes in the amount of the components of air inside the lift after one hour?

- A Amount of oxygen decreases
- B Amount of water vapour increases
- C Amount of carbon dioxide remains unchanged

- (1) A and B only
- (2) B and C only
- (3) A and C only
- (4) A, B and C

- 9 Ahmad counted the aquatic plants and animals found in his school eco-pond. He then plotted 2 bar graphs as shown below.

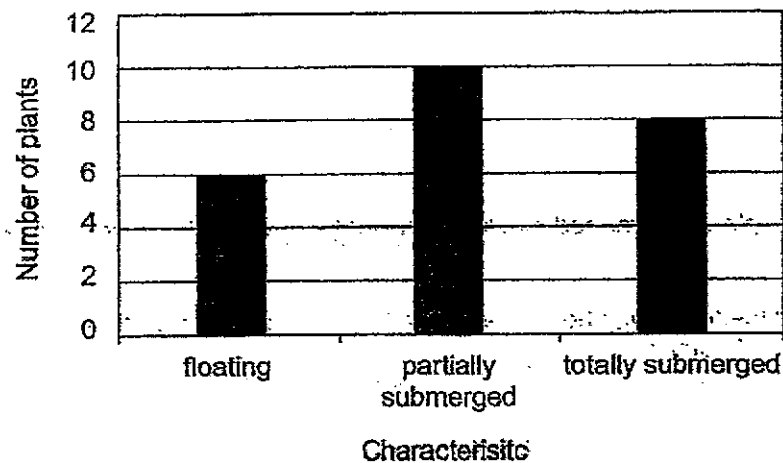
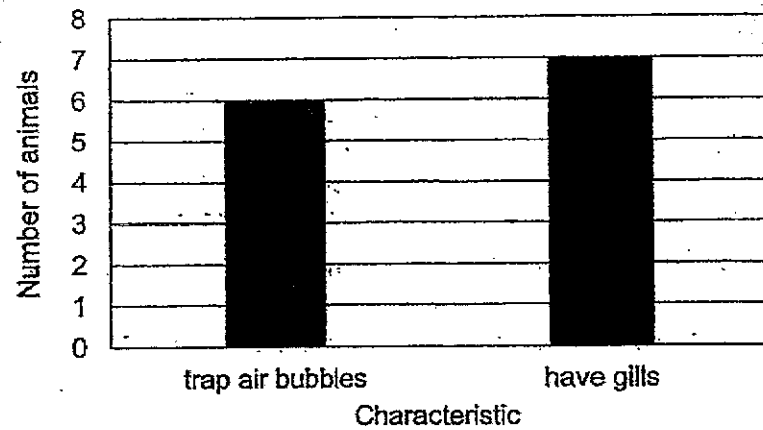

Based on the bar graphs, which of the following statements about the animals and plants in the pond are definitely correct?

- A There are 13 animals.
- B There are 7 fish in the pond.
- C There are 24 populations of plants.
- D There are at least 3 populations of plants.

- (1) A and D only
- (2) B and C only
- (3) A, C and D only
- (4) A, B, C and D

- 10 Tanya put 10 organism M and poured 100 ml of water into each of the four similar containers, P, Q, R and S.

She then added 100 ml of each type of substance X, Y and Z, into Q, R and S respectively as shown below. In container P, she added another 100 ml of water.

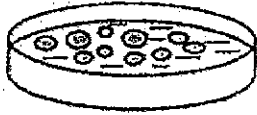

**Container P**

10 organism M in  
200 ml of water

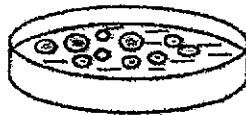

**Container Q**

10 organism M in  
100 ml of water with  
substance X

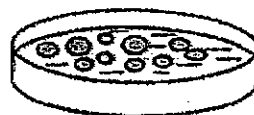

**Container R**

10 organism M in  
100 ml of water with  
substance Y

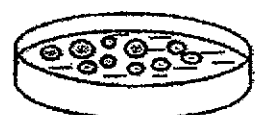

**Container S**

10 organism M in  
100 ml of water with  
substance Z

Tanya counted the number of organism M in each container over a period of 3 weeks and recorded her findings in the table below.

Container	Substance	Number of organism M			
		At the start of experiment	After 1 week	After 2 weeks	After 3 weeks
P	none added	10	12	16	22
Q	X	10	9	7	3
R	Y	10	12	23	44
S	Z	10	14	18	26

She made the following conclusions based on her findings.

- A Substances X, Y and Z are harmful to organism M.
- B Substance Y has no harmful effects on organism M.
- C Substances Y and Z contained nutrients for organism M.

Which of the above conclusions are likely to be correct?

- (1) A and B only
- (2) B and C only
- (3) A and C only
- (4) A, B and C

- 11 Fruit trees, vegetables and butterflies make up a community in Mr. Lee's farm.

Mr. Lee sprayed insecticide on the vegetables regularly when he found that they were being eaten by caterpillars. The butterflies in the farm pollinate the fruit trees.

How would the spraying of insecticide affect the amount of vegetables and fruits produced over a period of three months?

- A Number of fruits produced decreases.
- B Amount of vegetables produced increases.
- C Amount of vegetables produced decreases.
- D Number of fruits produced remains the same.

- (1) A and B
- (2) A and C
- (3) B and D
- (4) C and D

- 12 The diagram below shows an aquatic plant, the water hyacinth.

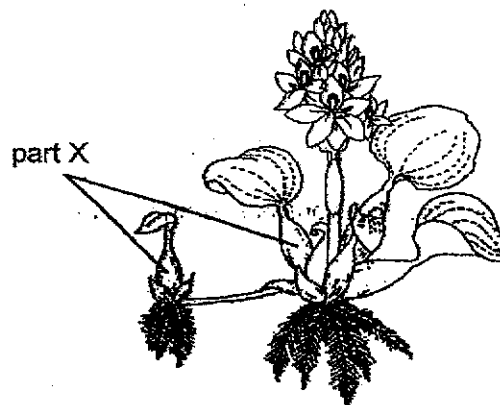

Part X of the plant is swollen.

Which of the following correctly shows the substance found in part X and the purpose of being filled with the substance?

	Substance	Purpose
(1)	air	enables the plant to float on water
(2)	air	makes the plant appear bigger to attract pollinators
(3)	water	stores water for the plant
(4)	water	transports water to the rest of the plant

13 The diagrams below show the reproductive systems of a human and a plant.

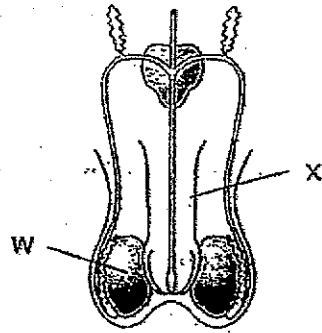

male reproductive system

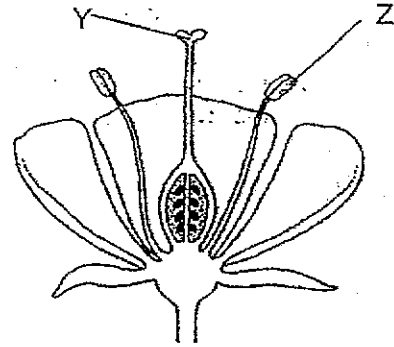

parts of a flower

Which of the following represent the parts involved in producing the male reproductive cells?

- (1) W and Z
- (2) W and Y
- (3) X and Z
- (4) X and Y

14 The diagram shows interactions taking place between organisms P, Q and R in a community.

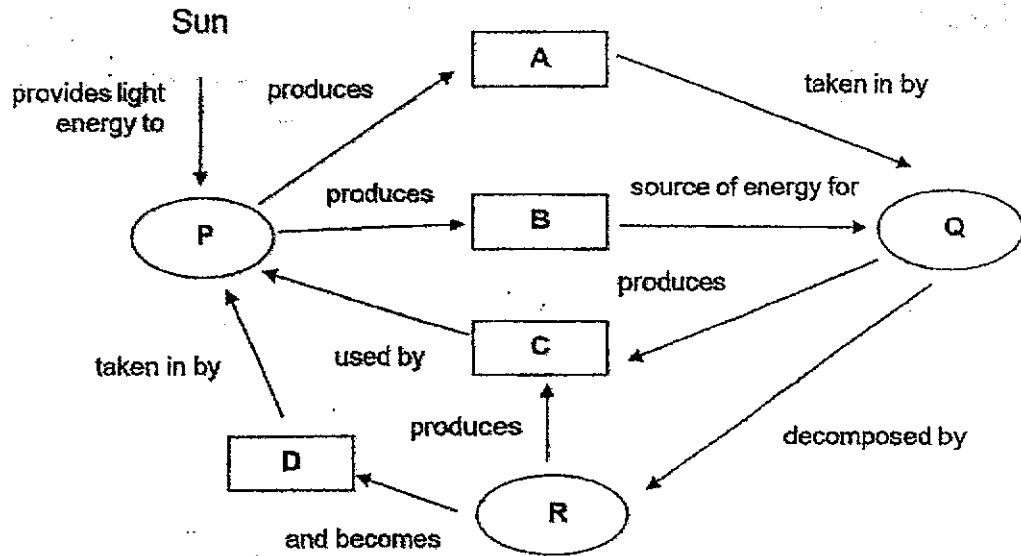

Which of the following correctly shows what A, B, C and D represent in the concept map above?

	A	B	C	D
(1)	oxygen	food	carbon dioxide	mineral salts
(2)	oxygen	carbon dioxide	mineral salts	food
(3)	food	oxygen	carbon dioxide	mineral salts
(4)	oxygen	mineral salts	food	carbon dioxide

15 The diagram shows the changes of states of water.

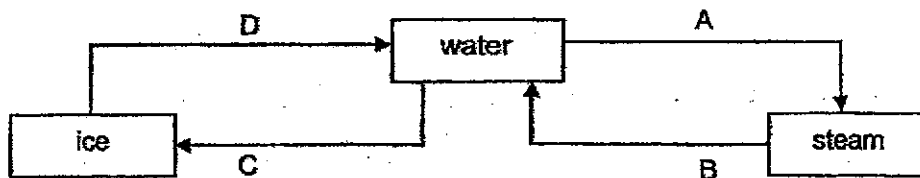

Which processes, A, B, C or D, involve heat loss or heat gain?

	Heat loss	Heat gain
(1)	A and B	C and D
(2)	B and D	A and C
(3)	B and C	A and D
(4)	C and D	A and B

- 16 The table below shows the states of 4 substances, W, X, Y and Z, at different temperatures.

Substance	State of substance at		
	25°C	60°C	95°C
W	Solid	Solid	Liquid
X	Liquid	Gas	Gas
Y	Solid	Liquid	Gas
Z	Solid	Liquid	Liquid

Which substance has the lowest boiling point?

- (1) W
  - (2) X
  - (3) Y
  - (4) Z
- 17 Megan wants to fix a steel ring onto a steel rod as shown below.

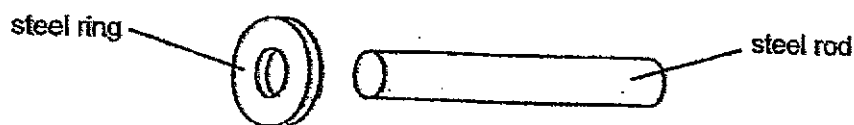

The rod is too big to fit into the hole of the ring when they are both at room temperature.

Which of the following actions will enable Megan to fit the rod into the ring?

- (1) Cool the rod and heat the ring.
- (2) Heat the rod and cool the ring.
- (3) Cool the rod and the ring to the same temperature.
- (4) Heat the rod and the ring to the same temperature.

18 Keith conducted an experiment as shown below.

Each beaker contained the same amount of water at different temperatures. He added five identical ice cubes onto each set-up. He measured the time taken for the first water droplet to drip into the beaker.

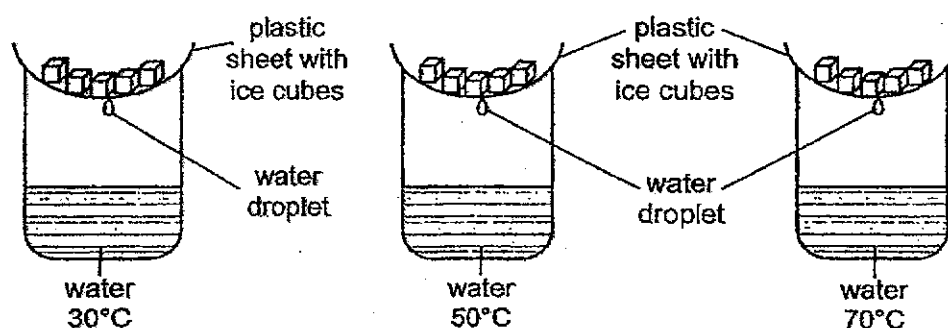

The table below shows the results of his experiment.

Temperature of water (°C)	Time taken for the first water droplet to drip (s)
30	100
50	70
70	20

What is the aim of Keith's experiment?

- (1) To find out how the temperature of water affects the rate the ice cubes melt.
- (2) To find out how the temperature of water affects the rate of evaporation of water.
- (3) To find out how the time taken for the first water droplet to drip affects the temperature of water.
- (4) To find out how the number of ice cubes affects the time taken for the first water droplet to drip.

- 19 Alan put a glass of liquid X into a basin of liquid Y as shown in the diagram below.

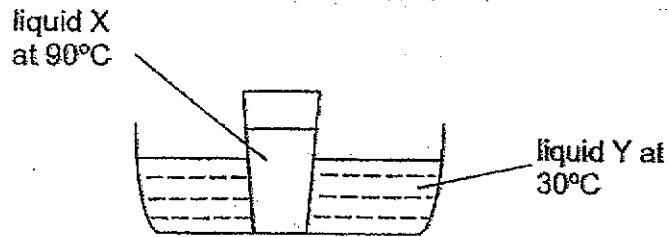

Which one of the following graphs correctly shows the changes in temperature of liquid X and Y after 2 hours?

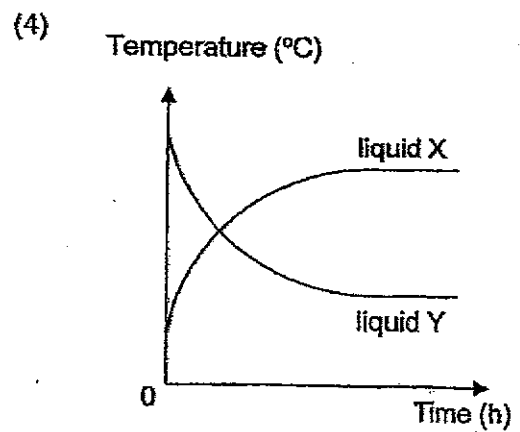
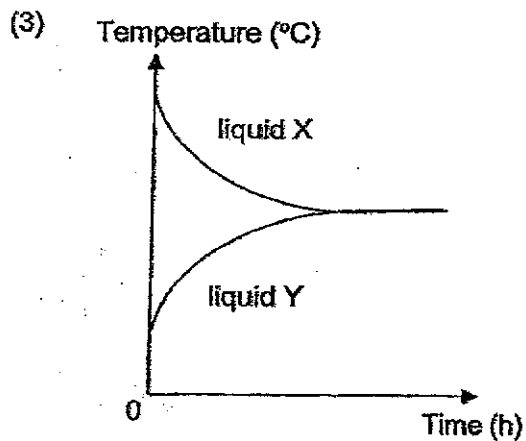
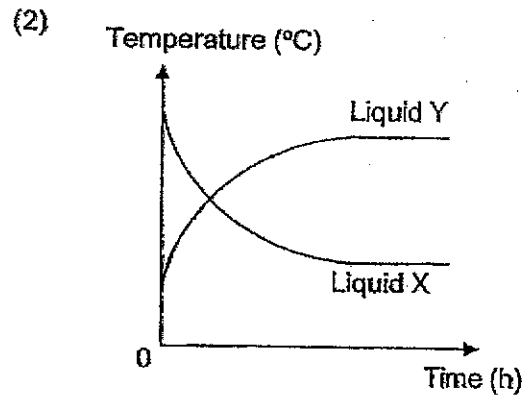
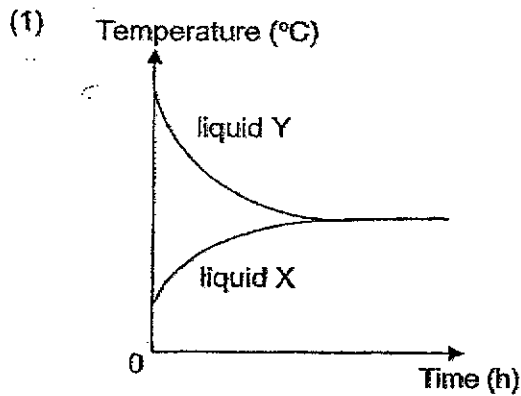

- 20 Siti was walking along a path from A to E.  
There are two lamps, L1 and L2, along the path, placed at different positions.  
The graph below shows how the length of her shadows changed from positions A to E.

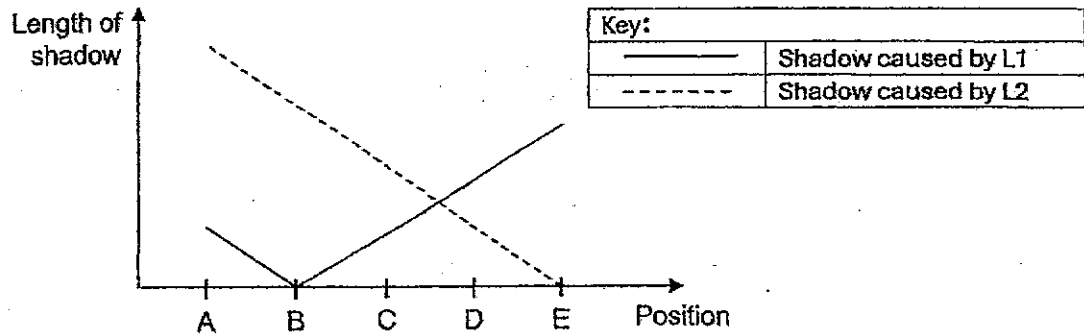

At which position is L1 and L2 at respectively?

	L1	L2
(1)	E	A
(2)	B	E
(3)	A	E
(4)	B	A

- 21 Study the four circuits shown below. The bulbs and batteries are identical.

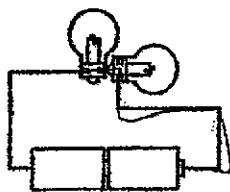

Circuit A

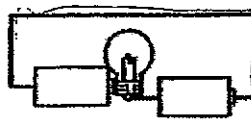

Circuit B

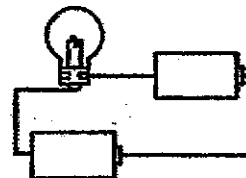

Circuit C

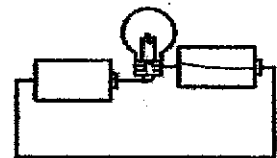

Circuit D

In which circuits would the bulb(s) light up?

- (1) A and B
- (2) A and C
- (3) B and D
- (4) C and D

- 22 Siew Ling has three rods, P, Q and R, made of different materials. She placed them in various positions, X, Y and Z, in the circuit shown below.

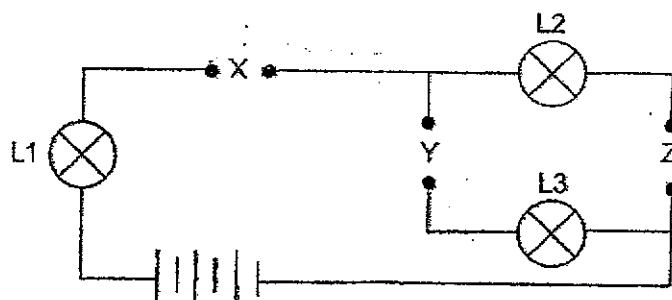

The results of the experiment are shown in the table below.  
A tick (✓) was placed in the box when the bulb lit up.

Position where rods were placed			Bulb		
X	Y	Z	L1	L2	L3
P	Q	R	✓	✓	
Q	R	P			
R	P	Q	✓		✓

Based on the results given, what can Siew Ling conclude?

- (1) Only rod R is not able to conduct electricity.
- (2) Only rods P and Q are able to conduct electricity.
- (3) Only rods P and R are able to conduct electricity.
- (4) Rods Q and R are better conductors of electricity than rod P.

- 23 The owner of a factory wanted to produce a vacuum flask to keep water warm for a long period of time. He wanted to find out which materials, P, Q, R or S, is the most suitable for making part X of the flask as shown in the diagram below.

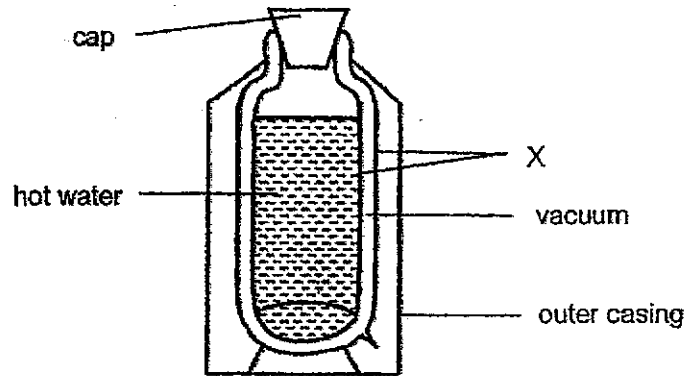

He studied the properties of the four types of materials and recorded his findings in a table below.

Material	Does it allow light to pass through?	Does it absorb water?	Is it a good conductor of heat?
P	Yes	No	Yes
Q	No	No	Yes
R	No	No	No
S	No	Yes	No

Which material is the most suitable for making part X of the flask?

- (1) Material P
- (2) Material Q
- (3) Material R
- (4) Material S

24 Tom is moving down a slope on his bicycle.

Which one of the following graphs shows the relationship between the amount of kinetic energy he has and the distance he travels down the slope?

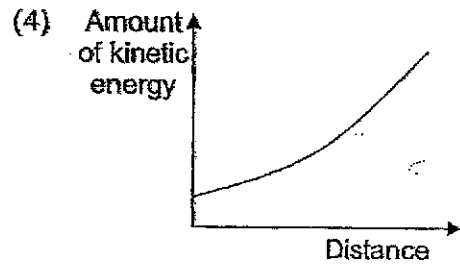
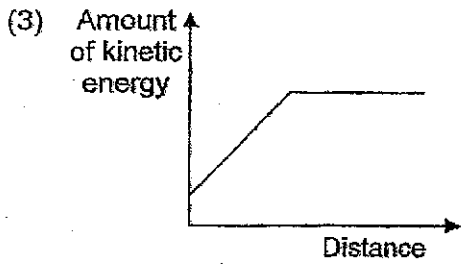
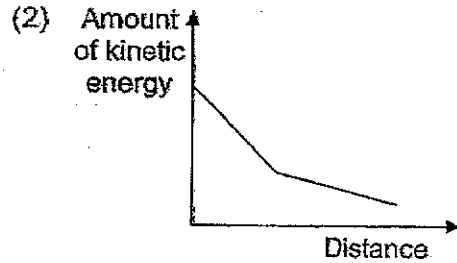
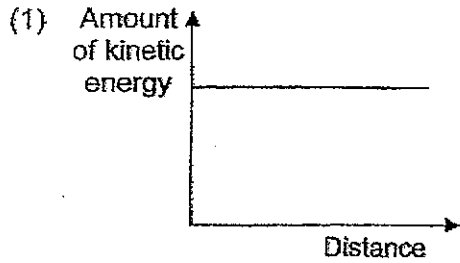

25 A girl kicked a plastic block as shown below.

The plastic block moved along the floor to X and then to Y. It stopped at Y.

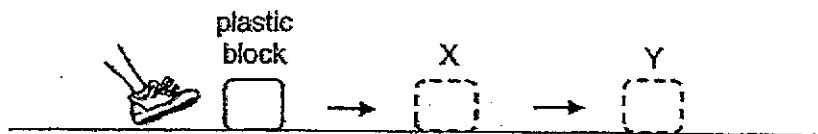

Which of the following is correct?

Forces acting on the plastic block at			
X		Y	
Friction	Weight	Friction	Weight
(1)	✓	✓	
(2)	✓		✓
(3)	✓	✓	✓
(4)		✓	✓

Key: ✓ : present

- 26 Ellen placed a ruler at the edge of the table and held it down firmly with her hand. Placing an eraser on the other end of the ruler, Ellen pressed the ruler down and then let go of the eraser.

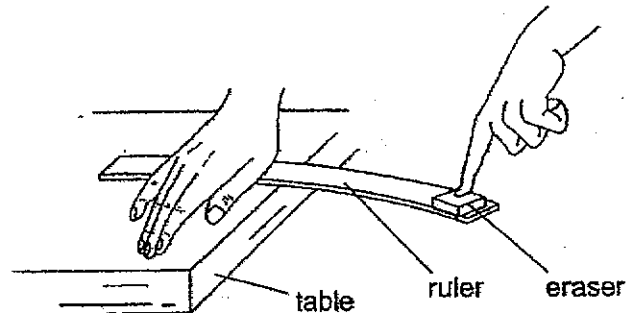

She observed that the eraser was thrown off the ruler.

Where did the eraser obtain its energy from?

- (1) From the bent ruler
  - (2) From the air surrounding the eraser
  - (3) From the masses of the ruler and the eraser itself
  - (4) From the hand that was holding the ruler down on the table
- 27 The diagram below shows a man clinging onto a vertical rock wall.

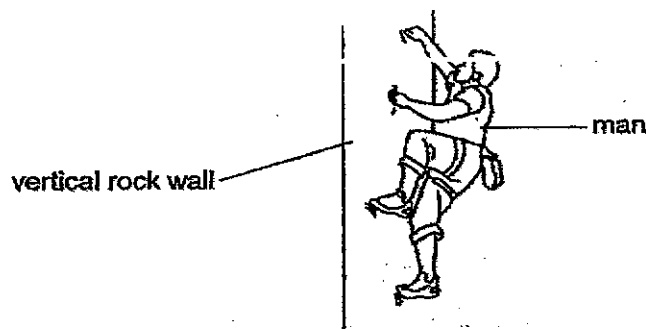

Which of the following is a possible explanation why the man is able to cling onto the rock wall?

- (1) The frictional force increases as he climbs up the wall.
- (2) The frictional force is greater than the weight of the man.
- (3) The weight of the man is greater than the gravitational force.
- (4) There is no gravitational force acting on the man when he is on the wall.

- 28 Jerry hangs magnet P from a spring as shown in diagram 1. He then places magnet Q on the ground directly beneath magnet P as shown in diagram 2.

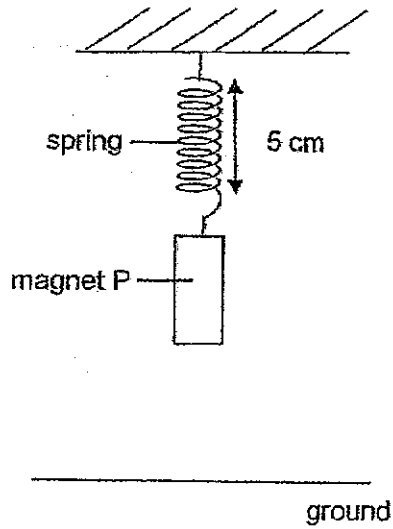

Diagram 1

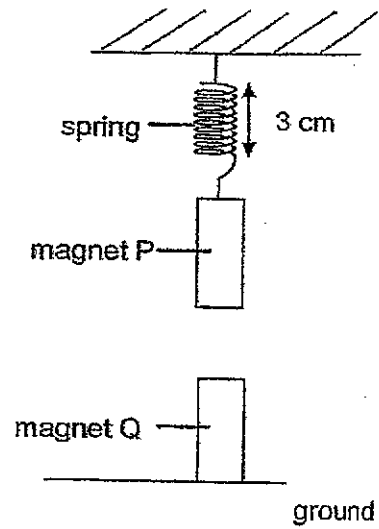

Diagram 2

Based on the diagrams only, which of the following statements are correct?

- A Magnet Q is stronger than magnet P.
  - B Magnets P and Q have the same magnetic strength.
  - C The like poles of magnets P and Q are facing each other.
- (1) B only
  - (2) C only
  - (3) A and C only
  - (4) B and C only

End of Booklet A





**HENRY PARK PRIMARY SCHOOL**  
**2024 PRELIMINARY EXAMINATION**  
**STANDARD SCIENCE**  
**PRIMARY SIX**  
**BOOKLET B**

Name: \_\_\_\_\_ (    )

Class: Primary 6 (    )

12 QUESTIONS

44 MARKS

**TOTAL TIME FOR BOOKLETS A & B: 1 HOUR 45 MINUTES**

**INSTRUCTIONS TO CANDIDATES**

1. Do not turn over this page until you are told to do so.
2. Follow all instructions carefully.
3. Answer all questions.



Marks for Booklet B: \_\_\_\_\_ / 44

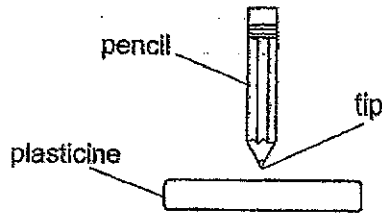

- 30 Asher conducted an experiment to find out how the type of pencil tip affects the depth it pierces into a block of plasticine. He used two identical pencils with different tips and dropped them from the same height.



He recorded his results in the table below.

Type of pencil tip	Depth of piercing (cm)	Does the pencil stay in the plasticine?
	1	No
	2	Yes

- (a) How does the type of pencil tip affect the depth of piercing? [1]

Mangrove trees grow in coastal areas that can be muddy or even flooded, depending on the tide. Mangrove seeds germinate while on the tree. Once the seedlings can make their own food, they drop into the soil below the parent plant.

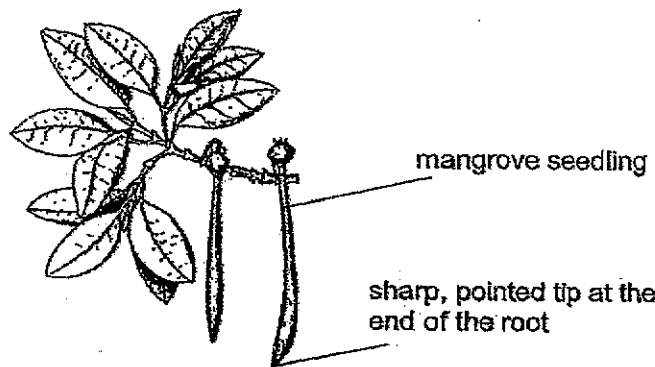

- (b) Based on Asher's experiment, explain how having a sharp tip at the end of the root increases the chance of the seedling growing into an adult plant. [1]

- (c) State a disadvantage when the seedling drops into the muddy soil below the parent plant and grows there. [1]

Please do not write in the margin.

Please do not write in the margin.

Please do not write in the margin.

31 Alex carried out an experiment to find out how exercise affects his heart rate. His results are shown in the table below.

When heart rate was measured	Heart Rate (beats per minute)
Before exercise	75
Immediately after running	140
After 5 minutes of rest	90

Explain the decrease in his heart rate after resting. [2]

---



---



---

32 Living things B and C live in the sea. The 2 graphs below show how an increase in the temperature of the sea affects the populations of living things B and C.

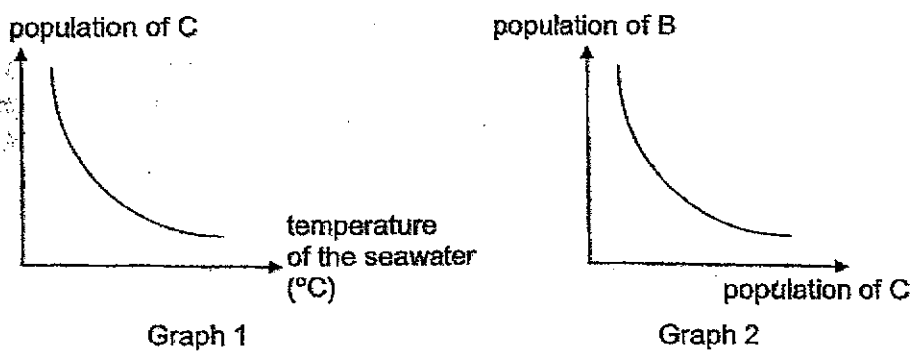

(a) What happens to the population of living thing B when the temperature of the seawater increases? [1]

---

(b) State the relationship between living things B and C. [1]

---

(c) Explain your answer in (b) using information from graphs 1 and 2. [2]

---



---



---

Please do not write in the margin.

Please do not write in the margin.



34 Mel set up the experiment shown below to investigate how temperature affects the rate of photosynthesis.

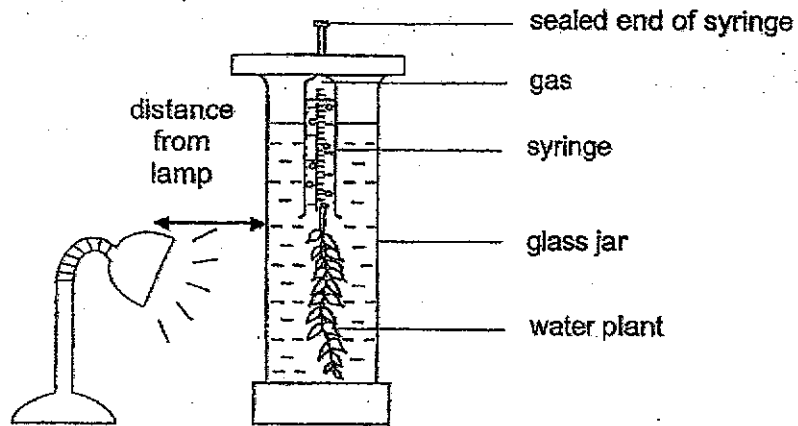

The number of bubbles produced per minute was counted at different temperatures and recorded in the table below.

Temperature (°C)	Number of bubbles produced per minute		
	Trial 1	Trial 2	Trial 3
10	7	6	8
15	12	14	11
20	20	19	17
25	36	34	32
30	50	52	51
35	42	44	45
40	3	2	1

Please do not write in the margin.

Please do not write in the margin.

(a) How did Mel measure the rate of photosynthesis in this experiment? [1]

---



---

(b) How does carrying out the experiment 3 times make the results more reliable? [1]

---



---

(c) Name another factor needed for the water plant to make food. [1]  
Explain how this factor can be kept the same throughout the experiment.

---



---

Please do not write in the margin.

- 35 Sarah wants a light bulb to light up when her toy train is pushed through a tunnel. She makes a tunnel using cardboard and puts a strip of metal foil inside the tunnel roof as shown below.

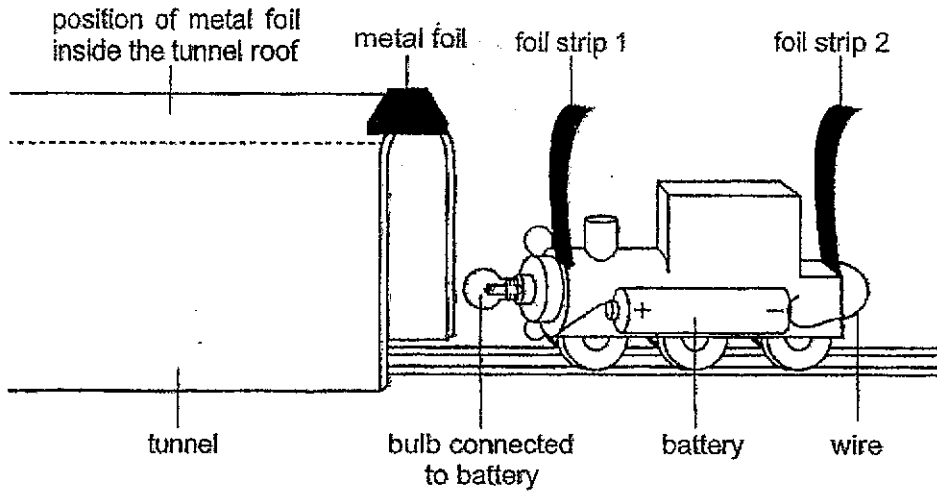

She realised that the bulb was too dim when the toy train was inside the tunnel.

- (a) Add another battery and complete the circuit below so that the light bulb becomes brighter when the circuit is closed. [2]

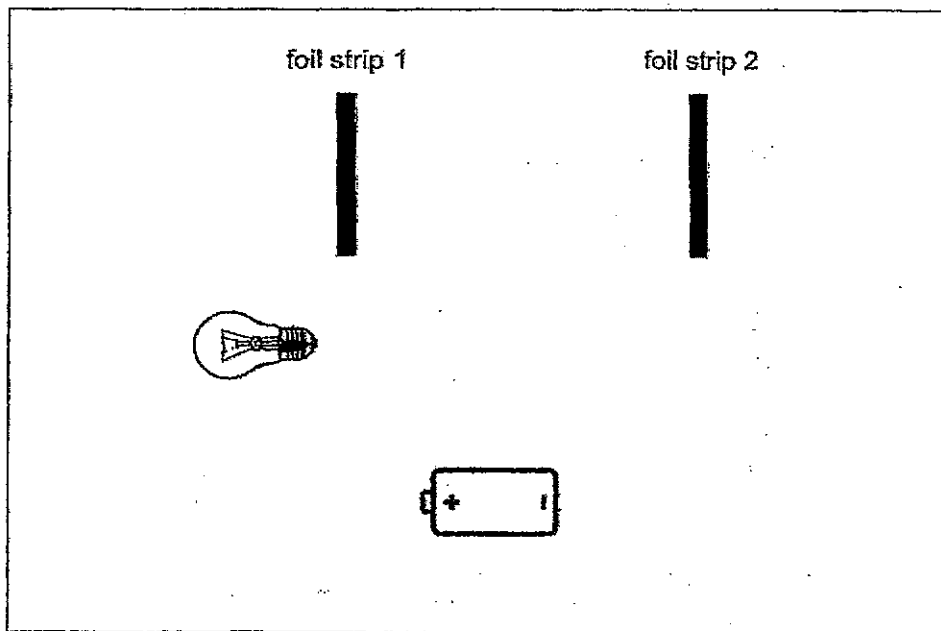

Please do not write in the margin.

Please do not write in the margin.





- 37 Ming Li conducted an experiment using the set-up shown below. He measured the temperature of the cold water at different times in the room.

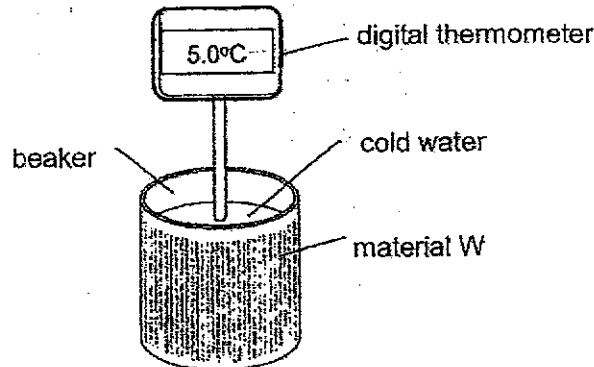

He repeated the experiment using material Y. He plotted his results as shown below.

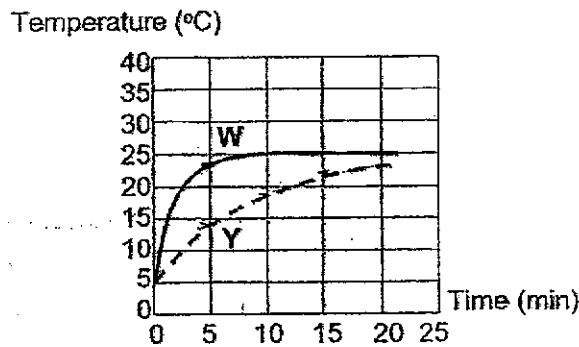

- (a) From the graph, state the room temperature.

[1]

The diagram shows an iron.

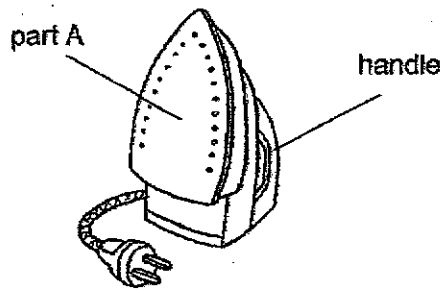

When part A of the iron is heated, the handle must be cool enough to be used safely by Ming Li.

- (b) Which material, W or Y, should be used to make the handle? Explain your answer.

[2]

Please do not write in the margin.

Please do not write in the margin.





39 (a) State what frictional force is.

[1]

---



---

Nathan conducted an experiment with a toy parachute. He released it with the canopy closed and then opened, from a height of 10 metres, as shown in the diagram.

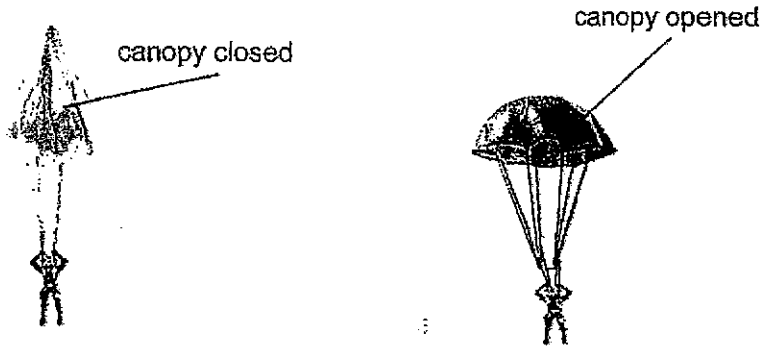

He recorded his findings in the table shown below.

Condition of canopy	Time taken for parachute to reach the ground (s)			
	1 <sup>st</sup> try	2 <sup>nd</sup> try	3 <sup>rd</sup> try	Average
closed	5	4	6	5
opened	8	10	9	9

(b) How does the condition of the canopy affect the time taken for the toy parachute to reach the ground? [1]

---



---

Please do not write in the margin.

Please do not write in the margin.







## HENRY PARK PRIMARY SCHOOL

## Booklet A

1) 3	2) 2	3) 4	4) 3	5) 3
6) 3	7) 2	8) 1	9) 1	10) 2
11) 1	12) 1	13) 1	14) 1	15) 3
16) 2	17) 1	18) 2	19) 3	20) 2
21) 3	22) 3	23) 3	24) 4	25) 2
26) 1	27) 2	28) 2		

## Booklet B

29

- (a) Benefit for bird P: Bird P has access to food and is able to feed on Ton R's body.  
Benefit for animal R: R does not have skin punctured by T as P preys on T.
- (b) If bird P is present, the chance of R spotting the humans is higher, and is able to spot them further away and 100% of the time, than if bird P was not present, allowing R to have a higher chance to escape being hunted by humans.

30

- (a) The sharp pencil tip pierces plasticine deeper than the blunt pencil tip.
- (b) A sharp tip of the mangrove seedling allows it to pierce into the soil deeper, and is able to stay in the soil, increasing the chance for the mangrove seed to grow into an adult plant.
- (c) The mangrove seedling will have to compete with the parent plant for space, sunlight, nutrients as it is overcrowding. (notes: please do not include water due to mangroves living in water, cannot compete)

31

Alex needed to use less energy when resting than running, reducing rate at which heart pumps, pumping less blood containing oxygen and digested food through the blood vessels to all parts of the body to respire less and releasing less energy and carbon dioxide, decreasing heart rate at her resting.

32

- (a) Population of organism B increases.
- (b) C is the predator of B, preying on B, and B is the prey of C.
- (d) As temperature of sea water decreases, population of C increases, population of B decreases, as more C prey on more B, decreasing number of B, and therefore population of B.

33

- (a) The amount of water on all the containers was the same to ensure amount of oxygen and carbon dioxide in water is same.
- (b) Yes, Q was affected by presence or absence of light while P was not affected by presence or absence of light. Plants use light, water and carbon dioxide to photosynthesize, affecting them while animals are not affected and do not use light making setups yellow, therefore P is animal.

34

- (a) Mel measured the rate of photosynthesis by measuring number of bubbles per minutes.
- (b) It ensures that results are consistent so as to make it a fair test.
- (c) Carbon dioxide. Pump the same amount of carbon dioxide into the glass jar at the start of each Trial, keeping the amount of carbon dioxide the same.

35

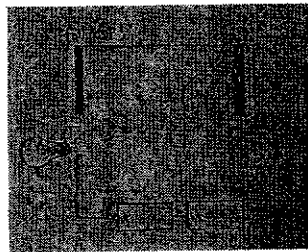

(a)

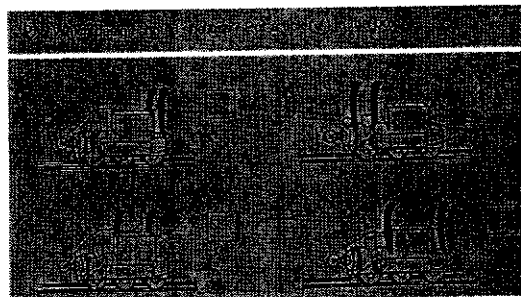

(b)

- (c) The foil strips at the front will be the quickest design for the foil strips to come into contact with the metal foil, closing the circuit the quickest, also electric current to flow through bulb quickest, lighting it up fastest.
- (d) Decrease. The bulbs are connected in series arrangement, making less electric current to flow through both bulbs, decreasing brightness of first bulb.

36

- (a) P: Gaseous state Q: liquid state
- (b) The water vapor in the surrounding air come into contact with cooler surface of tub, losing heat to form water droplets, which lost heat to cooler surface of tub, freezing to form smaller pieces of ice on the surface of tub, which is the white solid

37

- (a) 25 C
- (b) Y. Y is a worse conductor of heat than W, as it gained heat to return to room temperature in a longer period of time than W, so Y would gain heat from A slower than W, allowing user to hold the iron a longer period of time, therefore Y should make the handle.

38

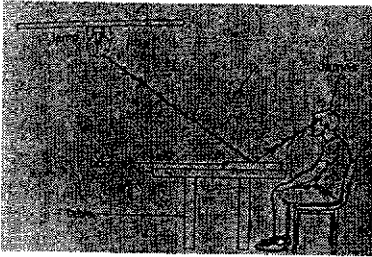

- (a)
- (b) R reflects light.
- (c) It allows for the use of only one bulb instead of two and produces the same amount of light, saving amount of electricity used.

39

- (a) Frictional force is a push force opposite to direction of which an object is moving, slowing it down. This causes wear and tear.
- (b) When canopy is closed, it takes a shorter amount of time to reach the ground, than when canopy is opened.
- (c) (i) Gravitational force (ii) Frictional force
- (d) It allows K to escape from predators easier as it remains a longer time not on ground, making it harder to spot.

40

- (a) Gravitational potential energy → Kinetic energy → Kinetic energy → Electrical energy
- (b) As d increases, water at the top has more gravitational potential energy, converted to more kinetic energy when running water falls, converted to more

kinetic energy of wheel, converted to more electrical energy by generator and producing more electricity.

- (c) The water wheel does not produce harmful chemicals or greenhouse gases, reducing climate change, benefiting the environment.