

Questions 1 to 10 carry 1 mark each. Questions 11 to 15 carry 2 marks each.
For each question, four options are given. One of them is the correct answer.
Make your choice (1, 2, 3 or 4) and shade your answer on the Optical Answer Sheet.
(20 marks)

1 Singapore's population was 6 014 723 last year. Express this number to the nearest thousand.

(1) 6 000 000

(2) 6 010 000

(3) 6 014 000

(4) 6 015 000

2 In 13.02, which digit is in the tenths place?

(1) 1

(2) 2

(3) 3

(4) 0

3 Rina makes a necklace using 12 pink pearls and 18 white pearls. What fraction of the pearls are white?

(1) $\frac{2}{5}$

(2) $\frac{3}{5}$

(3) $\frac{2}{3}$

(4) $\frac{3}{2}$

4 What is the value of $(63 + 27) + 3 - 12 \times 2$?

- (1) 6
- (2) 36
- (3) 48
- (4) 120

5 The bar graph shows the number of students in each Sports CCA.

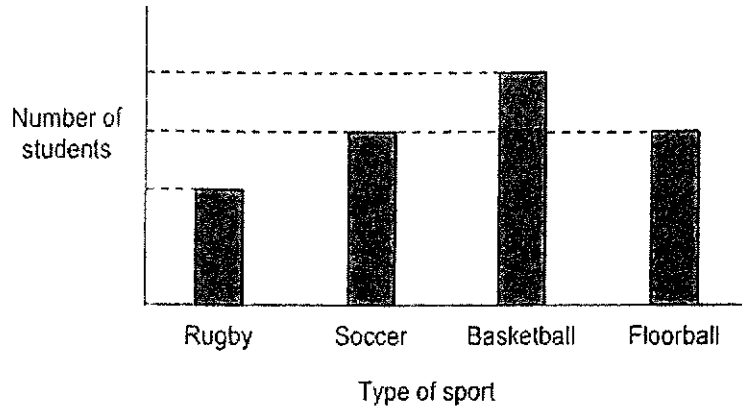

Which pie chart best represents the information in the bar graph?

- (1)
- (2)
- (3)
- (4)

6 The average of 3 numbers is 34. One of the numbers is 28. Which of the following are the other two numbers?

- (1) 42, 54
- (2) 36, 38
- (3) 30, 32
- (4) 24, 26

7 PQRS is a parallelogram and PSTU is a trapezium. Which of the following pair of lines are parallel?

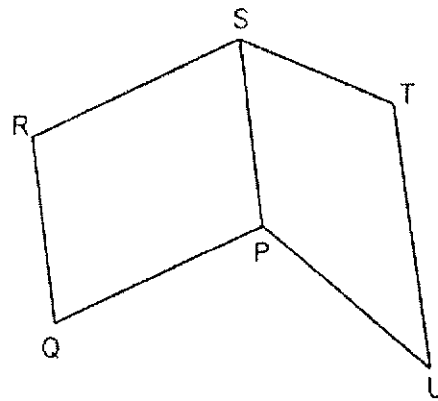

- (1) QR and ST
- (2) QR and UT
- (3) ST and PU
- (4) PS and RS

- 8 Three containers with some water are shown below. Arrange A, B and C from the largest volume of water to the smallest.

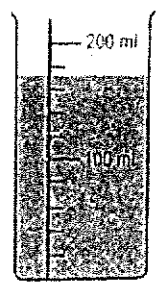

A

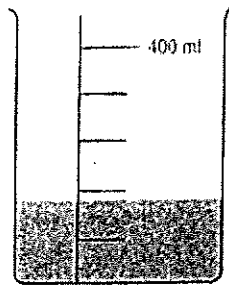

B

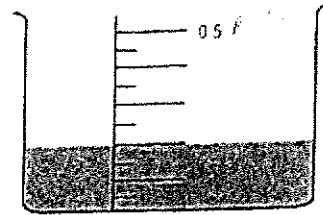

C

- (1) A, B, C
 (2) B, C, A
 (3) C, B, A
 (4) C, A, B

- 9 The figure below is made up of 5 identical quarter circles. The radius of each quarter circle is 10 cm. Find the area of the figure. Leave your answer in terms of π .

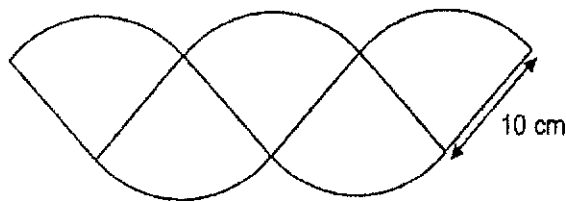

- (1) $125\pi \text{ cm}^2$
 (2) $75\pi \text{ cm}^2$
 (3) $50\pi \text{ cm}^2$
 (4) $25\pi \text{ cm}^2$

10 The figure below shows a prism

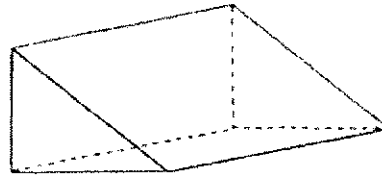

Which of the following are nets of the prism?

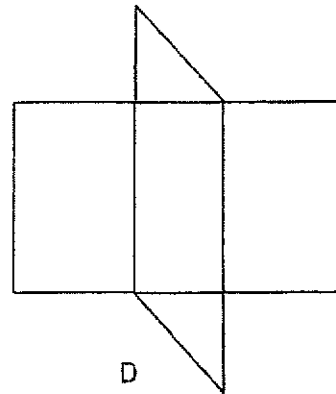
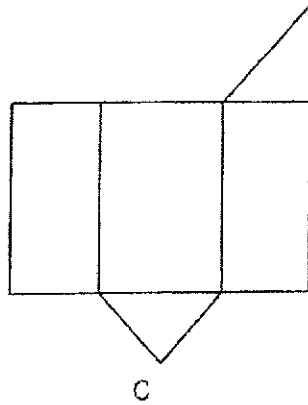
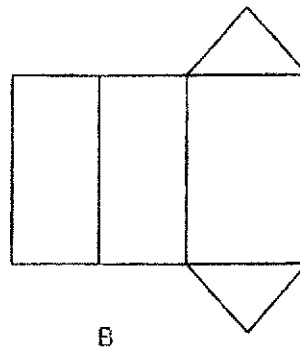
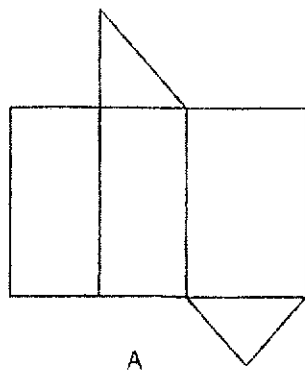

- (1) A and B only
- (2) A and C only
- (3) A, B and C only
- (4) All the above

- 11 The solid shown below is made up of 1-cm cubes. Owen takes the whole solid and dipped it completely in a pail of green paint. What is the total surface area of the solid figure painted in green?

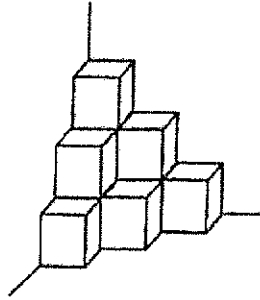

- (1) 18 cm^2
 (2) 24 cm^2
 (3) 30 cm^2
 (4) 36 cm^2
- 12 PQR is an equilateral triangle and STUV is a rhombus. QRST is a straight line and $\angle RVS = 52^\circ$. Find $\angle USV$.

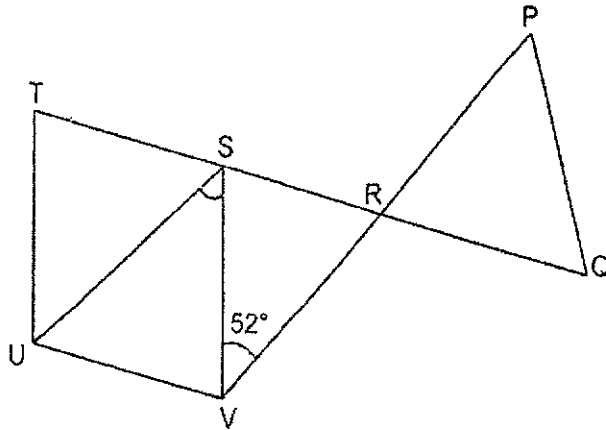

- (1) 38°
 (2) 52°
 (3) 56°
 (4) 68°

- 13 The table below shows the rates for renting a bicycle at a shop. Daisy rented two bicycles from 3:00 pm to 5:50 pm. She paid a total of \$32 for renting the bicycles.

First hour	\$8
Every additional 30 min or part thereof	?

How much did Daisy have to pay for every additional 30 min or part thereof for renting a bicycle?

- (1) \$6
- (2) \$2
- (3) \$8
- (4) \$4
- 14 At first, Mrs Ang had twice as many red beads as yellow beads. She used $\frac{2}{3}$ of her yellow beads and some of her red beads to make some necklaces. In the end, $\frac{3}{5}$ of the beads left were red beads. What fraction of her red beads did Mrs Ang use?

- (1) $\frac{1}{2}$
- (2) $\frac{2}{5}$
- (3) $\frac{3}{4}$
- (4) $\frac{7}{12}$

- 15 Mrs. Samy baked chocolate and strawberry cupcakes at a children's party. The number of chocolate cupcakes was $\frac{5}{7}$ the number of strawberry cupcakes. Mrs. Samy then baked some blueberry cupcakes. In end, 25% of the cupcakes were chocolate cupcakes. What percentage of cupcakes were blueberry cupcakes?
- (1) 25%
- (2) 35%
- (3) 40%
- (4) 60%

End of Booklet A

(Go on to Booklet B)

Anglo-Chinese School (Junior)



PRELIMINARY EXAMINATION (2024)

PRIMARY 6 MATHEMATICS PAPER 1 (Booklet B)

16 August 2024

Total Time for Booklets A and Booklet B : 1 hour

Name: _____ () Class: 6.()

INSTRUCTIONS TO CANDIDATES

1. Do not turn over this page until you are told to do so.
2. Follow all instructions carefully.
3. Answer all questions.
4. Use a dark blue or black ballpoint pen to write your answers in the space provided for each question.
5. The use of calculators is **NOT** allowed.
6. Do not use correction fluid/tape.
7. Do not use highlighters on any part of your answers.

This question paper consists of 9 printed pages and 1 blank page.

ACB

ACS

Questions 16 to 20 carry 1 mark each. Write your answers in the spaces provided.
 For questions which require units, give your answers to the units stated. (5 marks)

16 Find the value of $20.1 - 0.68$

Ans : _____

Please do not write in the margin

17 Find the value of $\frac{5}{7} \times \frac{8}{15}$

Give your answer in its simplest form.

Ans : _____

Please do not write in the margin.

18 The figure shows the net of a cuboid. The cuboid has a square base. Find the volume of the cuboid.

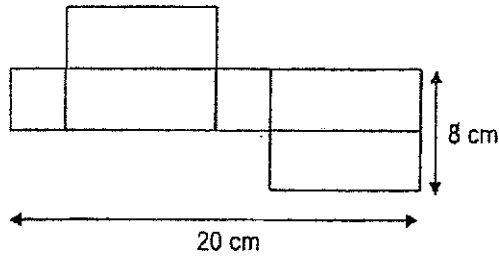

Ans : _____ cm³

Sub-Total :

(Go on to the next page)

ACSJ

ACSJ

19 Shade two squares to form a symmetric figure with AB as the line of symmetry.

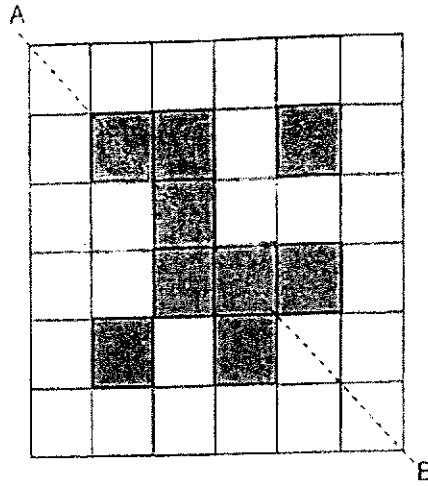

Please do not write in the margin

Please do not write in the margin

20 In the figure below, find the shaded area.

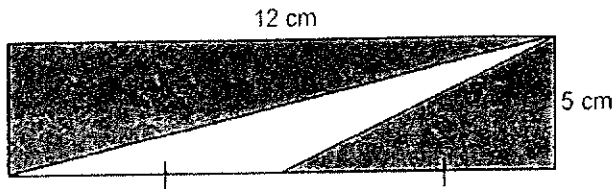

Ans : _____ cm²

Sub-Total :

Questions 21 to 30 carry 2 marks each. Show your working clearly and write your answers in the spaces provided. For questions which requires units, give your answers in the units stated.
(20 marks)

- 21 (a) Find the value of $\frac{2}{5} + \frac{3}{8}$.

Ans : (a) _____

- (b) Express 2.68 as a mixed number in the simplest form.

Ans : (b) _____

- 22 Peter placed some cups into a box and the total mass was 4 kg. James placed some plates into a similar box and the total mass was 10 kg. The plates were 3 times as heavy as the cups.

Each statement below is either true, false or not possible to tell from the information given above. For each statement, put one tick (✓) in the correct column.

Statement	True	False	Not possible to tell
(a) The mass of the plates was 9 kg.			
(b) The mass of the box was one-quarter the mass of the cups.			
(c) The mass of 1 plate is more than the mass of 1 cup.			

Sub-Total :

(Go on to the next page)

Please do not write in the margin

Please do not write in the margin

23

The timetable below shows the time of 4 different trains from City X to City Y.

Train	Train leaves City X	Train arrives at City Y
A	8.15 a.m.	10.05 a.m.
B	8.25 a.m.	10.40 a.m.
C	8.40 a.m.	11.00 a.m.
D	9.05 a.m.	11.20 a.m.

- (a) Find the time taken for Train D to travel from City X to City Y. Give your answer in h and min.

Ans : (a) _____ h _____ min

- (b) Sue wants to take a train to City Y. Her watch shows 8.20 a.m. when she arrives at the station in City X. She realises that her watch is 10 min slower. What is the earliest time she can reach City Y?

Ans : (a) _____ a.m.

Please do not write in the margin

Please do not write in the margin.

24

A rectangular piece of paper is folded as shown. Find $\angle y$.

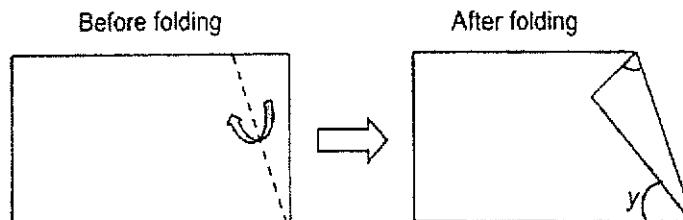

Ans : _____ °

Sub-Total :

25

Tom and Jerry were playing hide-and-seek at a playground. The grid below shows the positions of the different points that they were standing.

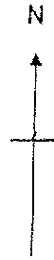
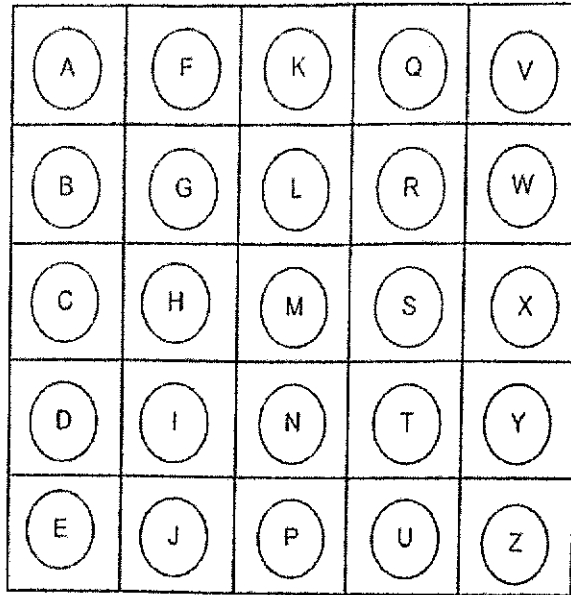

- (a) Tom walked directly from point J to point W in a straight line. In which direction did Tom walk from point J?

Ans : (a) _____

- (b) Jerry was standing from a certain point facing point A. He turned 180° clockwise and faced point Z. Which were all the possible points Jerry could be standing at?

Ans : (b) _____

Sub-Total :

(Go on to the next page)

Please do not write in the margin

Please do not write in the margin

ACSU

ANS

- 26 The line graph shows the volume of water in a tank over 40 min. Tap A was turned on for 40 min for water to flow into the tank. 15 min after Tap A was turned on, Tap B was also turned on.

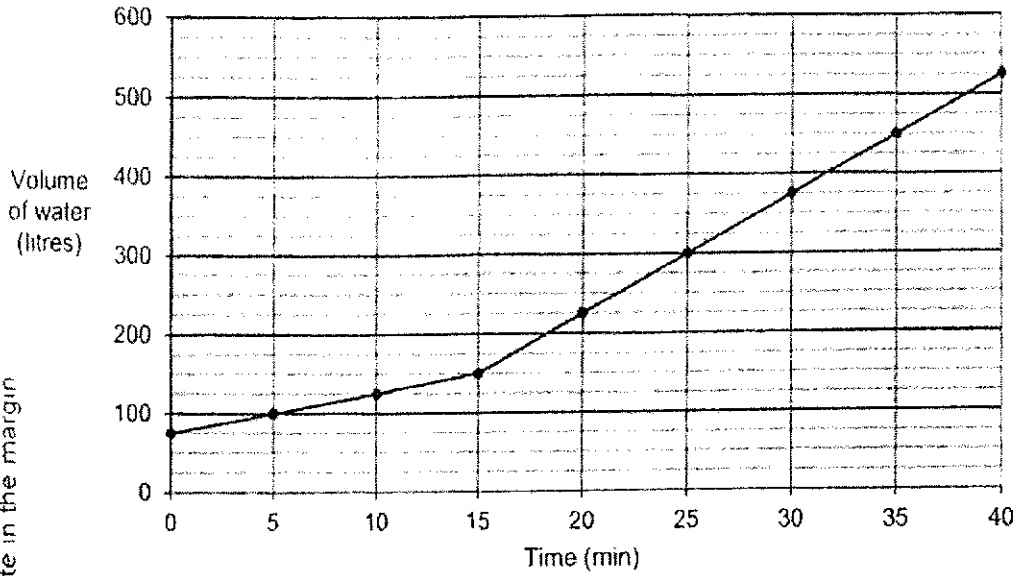

Please do not write in the margin

Please do not write in the margin

- (a) What is the increase in volume of water over the first 10 minutes?

Ans : (a) _____ ℓ

- (b) How many litres of water flowed into the tank in 1 minute after Tap B was turned on?

Ans : (b) _____ ℓ

Sub-Total :

ACSI

ACSI

27 Eileen had some posters. She bought $5k$ new posters and added them to the posters she had. However, 2 new posters were torn and she was left with $18k$ posters. Express the number of posters Eileen had at first in terms of k .

Ans : _____

Please do not write in the margin.

28 6 similar cubes were stacked to make a solid figure such that it has the following top and front views.

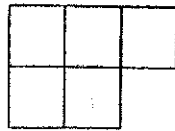

Top view

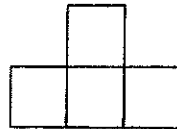

Front view

Draw the side view of the figure on the grid.

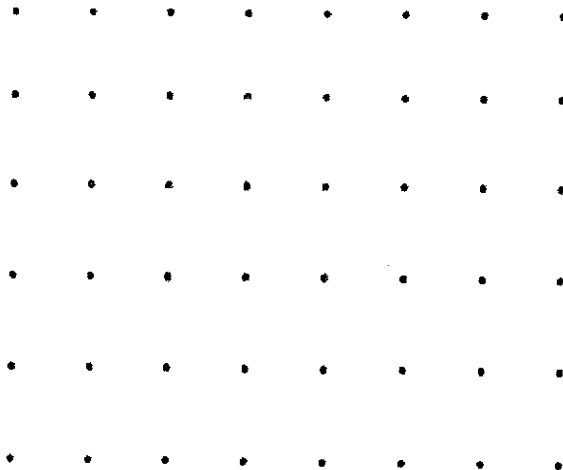

Please do not write in the margin.

Sub-Total :

(Go on to the next page)

29

Zhi Xiang went to a shop to buy a bag. The shop gave a discount of \$5 for every \$25 spent. Zhi Xiang paid \$96 for a bag. What was the price of the bag before the discount?

Ans : \$ _____

Please do not write in the margin.

30

STUV is a rectangle made up of Triangles A, C, D, E and a 4-sided figure B. The ratio of the area of B to the area of C is 3 : 1. The ratio of the area of A to the area of D to the area of E is 2 : 3 : 1. Express the area of A as a fraction of the area of B.

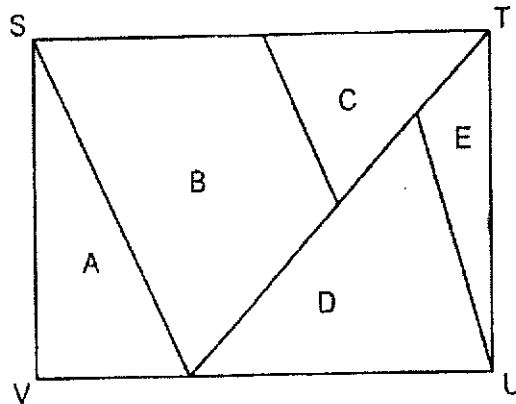

Please do not write in the margin.

Ans : _____

End of Booklet B

Sub-Total :

Anglo-Chinese School (Junior)



PRELIMINARY EXAMINATION (2024)

PRIMARY 6 MATHEMATICS PAPER 2

16 August 2024

Time : 1 hour 30 minutes

Name: _____ () Class: 6.()

Parent's Signature: _____

INSTRUCTIONS TO CANDIDATES

1. Do not turn over this page until you are told to do so.
2. Follow all instructions carefully.
3. Answer all questions.
4. Use a dark blue or black ballpoint pen to write your answers in the space provided for each question.
5. Do not use correction fluid/tape or highlighter.
6. The use of an approved calculator is allowed.

Paper	Booklet	Possible Marks	Marks Obtained
1	A	20	
	B	25	
2		55	
Total		100	

This question paper consists of 16 printed pages and 1 blank page.

Questions 1 to 5 carry 2 marks each. Show your working clearly and write your answers in the spaces provided. For questions which require units, give your answers in the units stated. (10 marks)

1 Christopher has \$63. What is the greatest number of cupcakes can he buy?

Box of 9 cupcakes - \$25

1 cupcake - \$3



Ans : _____

Please do not write in the margin

2

The table shows the times taken by five robots to complete a maze.

Robot	Time in seconds (s)
A	4.5
B	6.81
C	3.92
D	4.12
E	5.1

Please do not write in the margin

(a) Which robot was the fastest to complete the maze?

Ans : (a) _____

(b) Robot F completed the same maze. The average time taken for all 6 robots was 4.73 s. What was the time taken by Robot F to complete the maze?

Ans : (b) _____ s

Please do not write in the margin.

Sub-Total :

- 3 Figure 1 is an isosceles triangle with a perimeter of 40 cm. Figure 2 is made up of 4 such isosceles triangles. The perimeter of Figure 2 is 112 cm. What is the length of PQ of the isosceles triangle?



Figure 1

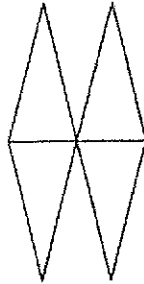
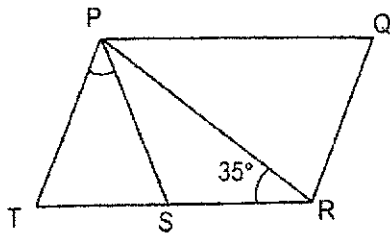

Figure 2

Please do not write in the margin

Ans : _____ cm

- 4 In the figure, PQRT is a parallelogram. $PT = PS = SR$ and $\angle PRS = 35^\circ$. Find $\angle SPT$.



Please do not write in the margin

Ans : _____ °

Please do not write in the margin.

Sub-Total :

ACSI

ACSI

5 Corrinne saved 20% of her monthly income. In August, her income decreased by 15%. As a result, her savings in August was decreased by \$120 compared to her savings in July. What was her income in July?

Please do not write in the margin

Please do not write in the margin

Ans : \$ _____

Please do not write in the margin.

Sub-Total :

For questions 6 to 17, show your working clearly and write your answers in the spaces provided. The number of marks available is shown in brackets [] at the end of each question or part-question. (45 marks)

- 6 The figure below shows a rhombus ABCD drawn on a grid.
- (a) Triangle BCE has the same area as rhombus ABCD. Draw triangle BCE on the grid below such that triangle BCE does not overlap with rhombus ABCD and $\angle CBE$ is more than 90° [2]

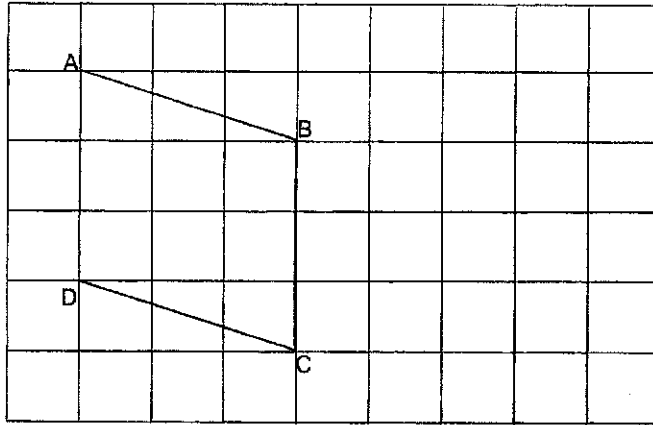

- (b) Draw a trapezium with the same perimeter as rhombus ABCD in part (a). [1]

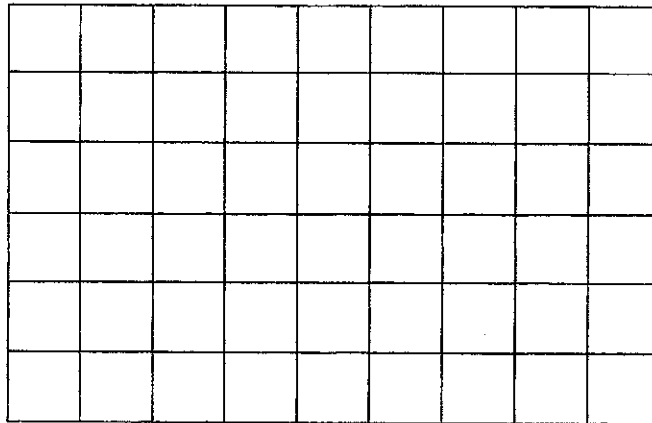

Please do not write in the margin

Please do not write in the margin

Please do not write in the margin.

Sub-Total :

7 The bar graph shows the number of tour packages Evelyn sold in 5 days. The bars that show the number of tour packages sold on Thursday and Friday have not been drawn.

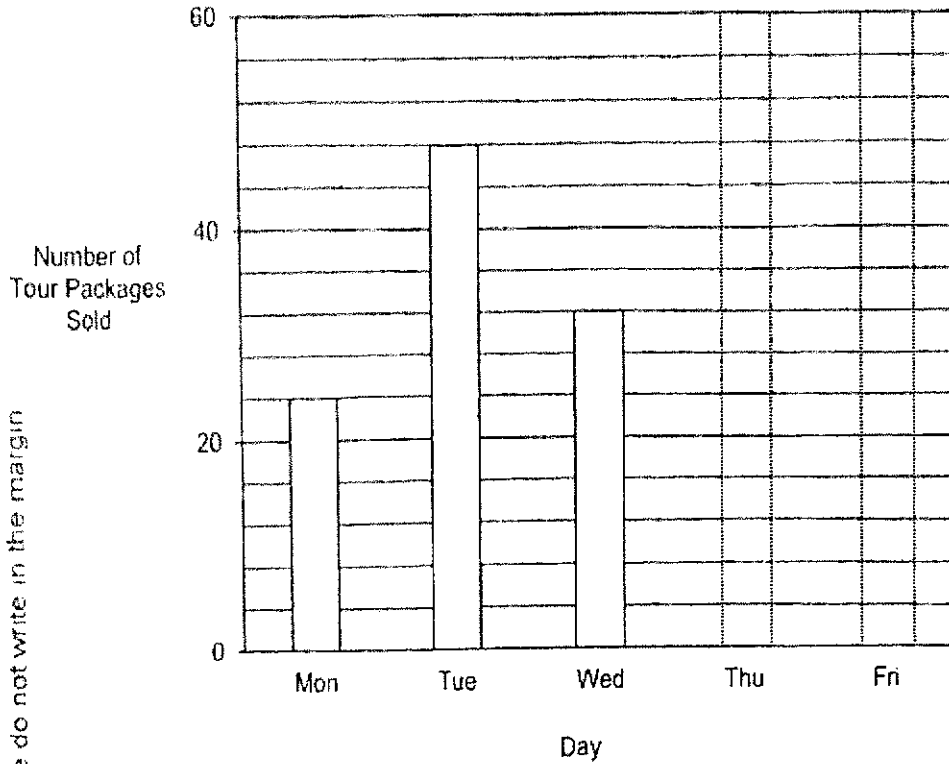

Please do not write in the margin

Please do not write in the margin

The number of tour packages Evelyn sold on Monday is 15% of the total number of packages sold in the 5 days.

(a) What is the total number of tour packages Evelyn sold in 5 days?

Ans : (a) _____ [1]

(b) The ratio of the number of tour packages sold on Thursday to the number of tour packages sold on Friday is 3 : 4.

Draw the bar representing the number of tour packages sold on Thursday and on Friday in the graph above. [2]

Please do not write in the margin.

Sub-Total

Empty box for Sub-Total

- 8 Vinesh drove from Singapore to Malacca at an average speed of 90 km/h. On the return journey, he took the same route and covered $\frac{1}{3}$ of the distance in 1 hour. Then he reduced his speed to 70 km/h for the rest of the journey. Vinesh took 4 hours for the return journey. How long did he take to drive from Singapore to Malacca?

Please do not write in the margin

Please do not write in the margin

Ans : _____ [3]

Please do not write in the margin.

Sub-Total :

- 9 A rectangular piece of paper ADCG was folded into the shape as shown. $AG = x$ cm, $GF = 12$ cm and $DE = 3$ cm.

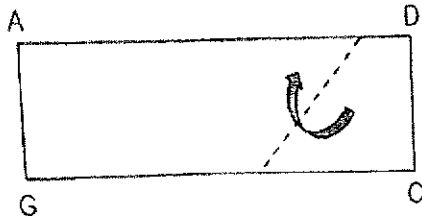

Before folding

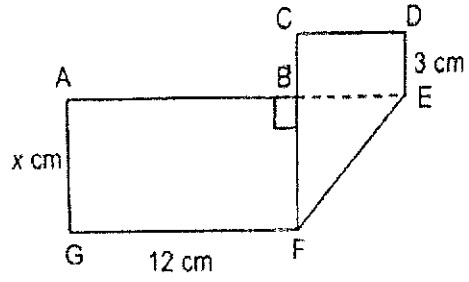

After folding

- (a) Find the perimeter of the rectangular piece of paper ADCG in terms of x . Give your answer in the simplest form.

Ans : (a) _____ [1]

- (b) Find the area of the triangle BEF when $x = 4$ cm.

Ans : (b) _____ [2]

Please do not write in the margin

Please do not write in the margin

Please do not write in the margin.

Sub-Total :

- 10 A shop sold electronic devices was having a sale as shown below





Electronics Sale!

1st item at 15% discount

2nd item at 20% discount



Price of 2nd item must be equal or lower than the price of 1st item.

- (a) Mr. Poh bought a tablet at \$230 and a laptop at \$550. How much did he pay for the two items

Ans : (a) _____ [2]

- (b) Mr. Chian bought two identical smart watches. He received a total discount of \$147. What was the price of one smart watch before the discount?

Ans : (b) _____ [2]

Please do not write in the margin.

Sub-Total :

Please do not write in the margin

Please do not write in the margin

AC&J

- 11 ABCD and EGFC are identical rhombuses overlapping each other. BHD is a straight line and $\angle CFG = 76^\circ$.

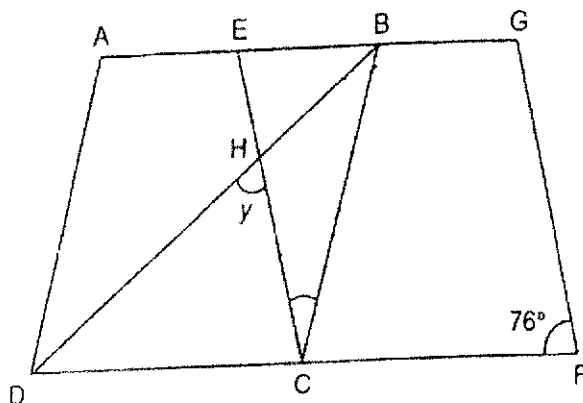

Please do not write in the margin

- (a) Find $\angle x$.

Ans : (a) _____ [1]

- (b) Find $\angle y$.

Ans : (b) _____ [3]

Please do not write in the margin.

Please do not write in the margin.

Sub-Total :

12 Ray uses lines and dots to form figures that follow a pattern as shown below.



Figure 1

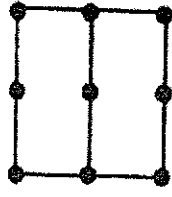

Figure 2

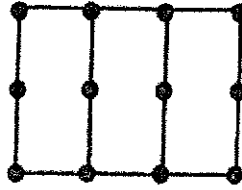

Figure 3

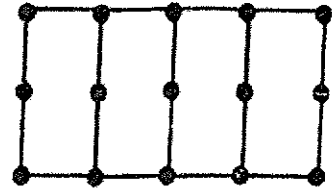

Figure 4

The table shows the number of lines and dots for the first four figures.

(a) Complete the table for Figure 5.

Figure Number	Number of dots	Number of lines
1	6	6
2	9	10
3	12	14
4	15	18
5		

[1]

(b) A figure in the pattern has 108 dots. What is the Figure number?

Ans : (b) Figure _____ [1]

(c) Find the total number of dots and lines in Figure 72.

Ans : (c) _____ [2]

Please do not write in the margin.

Please do not write in the margin

Please do not write in the margin.

Sub-Total :

- 13 At first, Tank A with $\frac{2}{5}$ filled with water. Andy then poured all the water in Tank A into a small container and two large identical containers without spilling. The height of all the 3 containers were the same and all the 3 containers were filled to the brim.

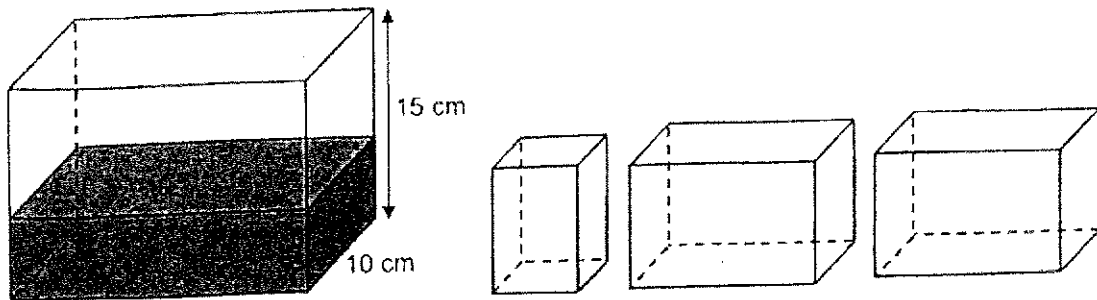

30 cm

Tank A

- (a) What was the volume of water in Tank A at first?

Ans : (a) _____ [1]

- (b) The base area of the small container is 60 cm^2 and the base area of each large container is 120 cm^2 . Find the capacity of the small container.

Ans : (b) _____ [3]

Please do not write in the margin.

Sub-Total :

Please do not write in the margin

Please do not write in the margin.

14 Peter designed a logo for a poster as shown.

(a) What was the total area of the shaded logo?

(Take $\pi = \frac{22}{7}$)

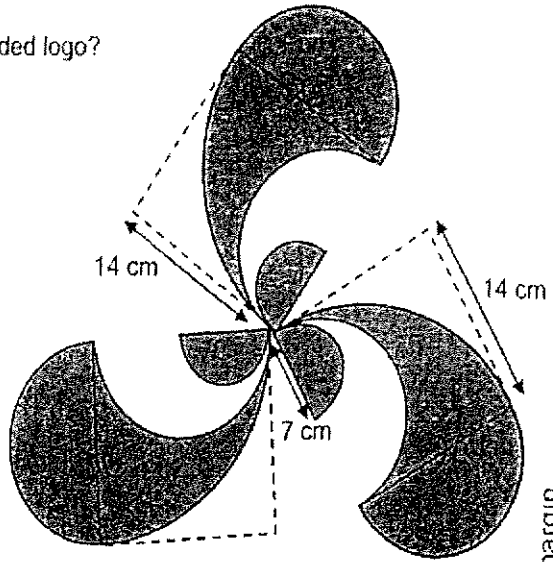

Please do not write in the margin

Please do not write in the margin

Ans : (a) _____ [2]

(b) What was the perimeter of the logo?

Ans : (b) _____ [3]

Please do not write in the margin.

Sub-Total :

- 15 Tina had a total of 754 pearl necklaces and bead necklaces for sale. After selling twice as many pearl necklaces as bead necklaces, she had $\frac{1}{3}$ of the pearl necklaces and $\frac{1}{4}$ of the bead necklaces left. What was the total number of pearl and bead necklaces left?

Please do not write in the margin

Please do not write in the margin

Ans : _____ [3]

Please do not write in the margin.

Sub-Total :

ACSJ

16 At a school bookshop, erasers are only sold in packs of 4 and pencils are only sold in packs of 5.

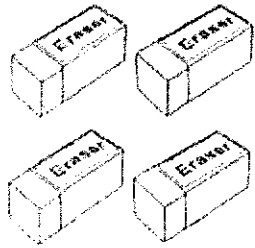
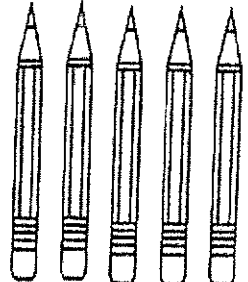
	
<p>Erasers 4 for \$1.99</p>	<p>Pencils 5 for \$2.99</p>

Mr Lim spent \$139.45 buying some erasers and pencils for Children's Day. He put all the erasers and pencils into bags. The ratio of the number of erasers to the number of pencils in each bag was 2 : 3. How many pencils did he buy?

Please do not write in the margin

Please do not write in the margin.

Ans : _____ [4]

Please do not write in the margin.

Sub-Total :

- 17 Gary spent $\frac{5}{8}$ of his money on 10 identical notebooks and 10 identical files. Then, he spent $\frac{5}{6}$ of his remaining money on a bag.

(a) What fraction of Gary's money was spent on the bag?

Ans : (a) _____ [1]

(b) Each file cost \$4 more than each notebook and the bag cost \$38 more than each notebook. How much money had Gary left?

Ans : (b) _____ [4]

End of Paper 2

Please do not write in the margin.

Sub-Total :

Please do not write in the margin

Please do not write in the margin

SCHOOL : Anglo-Chinese(Junior)PRIMARY SCHOOL
 LEVEL : PRIMARY 6
 SUBJECT : MATH
 TERM : 2024 Prelim

PAPER 1 BOOKLET A

Q 1	Q2	Q3	Q4	Q5	Q6	Q7	Q8	Q9	Q10
4	4	2	1	3	2	2	4	1	3

Q 11	Q12	Q13	Q14	Q15
4	3	2	3	3

PAPER 1 BOOKLET B

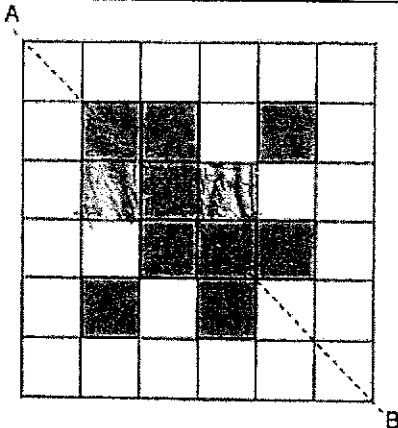
Q16)	$20.10 - 0.68 = 19.42$
Q17)	$\frac{5}{7} \times \frac{8}{15} = \frac{5 \times 8}{7 \times 15} = \frac{40}{105} = \frac{40 \div 5}{105 \div 5} = \frac{8}{21}$
Q18)	Volume = $6 \times 4 \times 4 = 96\text{cm}^3$
Q19)	
Q20)	$\frac{1}{2} \times 6 \times 5 = 15\text{cm}^2$ $60\text{cm}^2 - 15\text{cm}^2 = 45\text{cm}^2$
Q21 - a)	$\frac{2}{5} + \frac{3}{8} = \frac{16}{40} + \frac{15}{40} = \frac{31}{40}$
b)	$2 \frac{68}{100} = 2 \frac{34}{50} = 2 \frac{17}{25}$

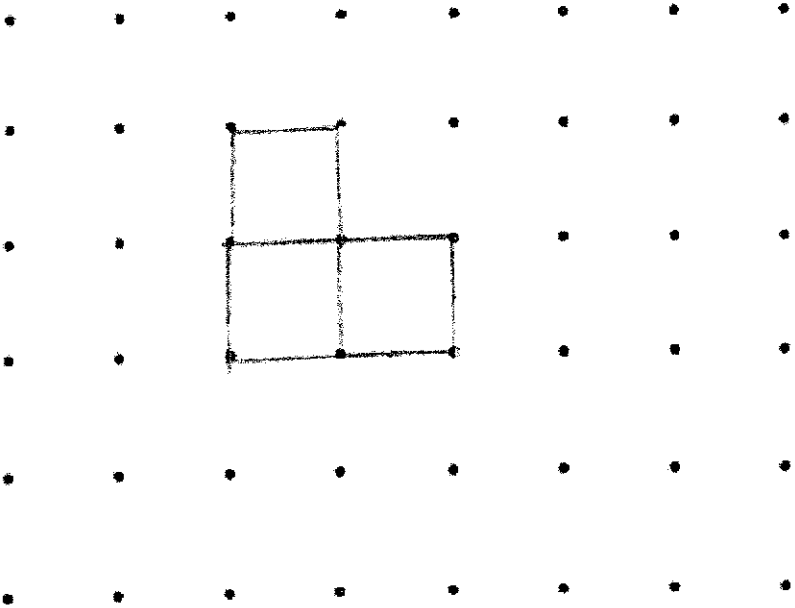
Q22)	Statement	True	False	Not possible to tell
	(a) The mass of the plates was 9kg.	√		
	(b) The mass of the box was one-quarter the mass of the cups.		√	
	(c) The mass of 1 plate is more than the mass of 1 cup.			√
Q23 - a)	11.20a.m – 9.05a.m = 2hr 15mins			
b)	11.00 a.m			
Q24)	$180^\circ - 90^\circ - 78^\circ = 12^\circ$ $12^\circ + 12^\circ + y = 90^\circ$ $y = 66^\circ$			
Q25 - a)	North - East			
b)	M , G , T			
Q26 - a)	$125 \ell - 75 \ell = 50 \ell$			
b)	$225 \ell - 150 \ell = 75 \ell$ (5mins) $1 \text{ min} = 75 \ell \div 5 = 15 \ell$			
Q27)	$18k + 2 = \text{original} + \text{bought}$ $18k - 5k = 13k + 2$			
Q28)				
Q29)	Zhi Xiang spent \$116 , discounted \$20 = \$96 $\$96 + \$20 = \$116$			
Q30)				

	<p>Given:</p> <ul style="list-style-type: none"> • Area of B : Area of C = 3 : 1 • Area of A : Area of D : Area of E = 2 : 3 : 1 <p>Step 1:</p> <p>Let the area of C be x, so the area of B is $3x$.</p> <p>Step 2:</p> <p>Let the areas of A, D, and E be $2y$, $3y$, and y respectively.</p> <p>Step 3:</p> <p>Express the area of A as a fraction of the area of B:</p> <p>Since the final answer needs to be in a simplified form and assuming y is proportional to x, the expression simplifies directly:</p> $\frac{\text{Area of A}}{\text{Area of B}} = \frac{2}{3}$ <p>This fraction correctly represents the area of A as a fraction of the area of B.</p>
--	--

PAPER 2

Q1)	<p>1 Box = 9 cupcakes = \$25</p> <p>2 Boxes = \$25x2 (18 cupcakes)</p> <p>\$63 - \$50 = \$13</p> <p>\$13 ÷ \$3 = 4.33 cupcakes</p> <p>18 + 4 = 22 cupcakes</p>
Q2 - a)	C
b)	<p>4.73 s x 6 = 28.38</p> <p>Robot F = 28.38 - 4.5 - 6.81 - 3.92 - 4.12 - 5.1</p> <p>= 3.93 s</p>
Q3)	<p>8 lengths of triangle = 112</p> <p>1 length = 112 ÷ 8 = 14cm</p> <p>PQ = 40cm - 14cm - 14cm</p> <p>= 12cm</p>
Q4)	<p>∠PSR = 180° - 35° - 35°</p> <p>= 110°</p> <p>∠PST = 180° - 110°</p> <p>= 70°</p> <p>∠SPT = 180° - 70° - 70°</p> <p>= 40°</p>
Q5)	<p>20% x 85% = 17%</p> <p>20% - 17% = 3%</p> <p>3% = \$120</p>

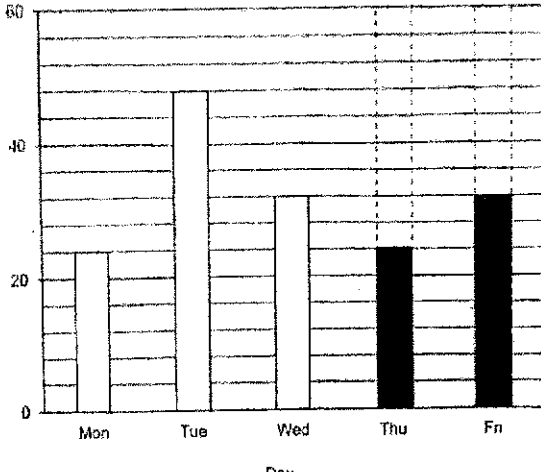
	$1\% = \$120 \div 3 = \40 $100\% = \$40 \times 100 = \4000												
Q6 - a)													
b)													
Q7 - a)	$15\% \text{ of total} = 24$ $100\% = 160$												
b)	$160 - 24 - 48 - 32 = 56$ $\frac{3}{7} \times 56 = 24$ $\frac{4}{7} \times 56 = 32$  <table border="1" data-bbox="406 683 949 1153"> <caption>Bar Chart Data</caption> <thead> <tr> <th>Day</th> <th>Value</th> </tr> </thead> <tbody> <tr> <td>Mon</td> <td>24</td> </tr> <tr> <td>Tue</td> <td>48</td> </tr> <tr> <td>Wed</td> <td>32</td> </tr> <tr> <td>Thu</td> <td>24</td> </tr> <tr> <td>Fri</td> <td>32</td> </tr> </tbody> </table>	Day	Value	Mon	24	Tue	48	Wed	32	Thu	24	Fri	32
Day	Value												
Mon	24												
Tue	48												
Wed	32												
Thu	24												
Fri	32												
Q8)	$\frac{2}{3}$ distance takes 3 hrs = 210 km Total distance = 315 km $315 \text{ km} \div 90 \text{ km/hrs} = 3.5 \text{ hrs}$												
Q9 - a)	Breadth = x cm Length = $(15 + x)$ cm Total Perimeter = $(30 + 4x)$ cm												
b)	Area BEF = $\frac{1}{2} \times 4 \times 4 = 8 \text{ cm}^2$												
Q10 - a)	$85\% \times \$550 = \467.50 $80\% \times \$230 = \184 Total = $\$467.50 + \$184 = \$651.50$												
b)	$85\% + 80\% = 165\%$ $200\% - 165\% = 35\%$ $35\% = \$147$ $100\% = \$420$												
Q11 - a)	$\angle BCF = 180^\circ - 76^\circ$ $= 104^\circ$ $\angle X = 104^\circ - 76^\circ$ $= 28^\circ$												

b)	$\angle ECD = 180^\circ - 76^\circ - 28^\circ$ $= 76^\circ$ $76^\circ + 28^\circ = 104^\circ$ $(180^\circ - 104^\circ) \div 2 = 38^\circ$ $\angle y = 180^\circ - 38^\circ - 76^\circ$ $= 66^\circ$
Q12 - a)	Number of dots = 18 Number of lines = 22
b)	$108 \div 3 = 36$ $36 - 1 = 35$
c)	Figure 72 Dots = $73 \times 3 = 219$ Lines = $219 + 72 - 1 = 290$ Total = $219 + 290 = 509$
Q13 - a)	Volume = $\frac{2}{5} \times 30 \times 10 \times 15$ $= 1800 \text{ cm}^3$
b)	Base of small is 1y Base of each big is 2y Volume of large must be twice of small $1800 \div 5 = 360 \text{ cm}^3$
Q14 - a)	Area of the quadrants = $\frac{3}{4} \times \frac{22}{7} \times 14 \times 14 = 462 \text{ cm}^2$ Area of the semi-circles = $\frac{3}{2} \times \frac{22}{7} \times 3.5 \times 3.5 = 57.75 \text{ cm}^2$ Total area = 519.75 cm^2
b)	$(\frac{1}{2} \times \frac{22}{7} \times 7) + 11\text{cm} + 7\text{cm} = 18\text{cm}$ Perimeter of one X = $\frac{1}{4} \times \frac{22}{7} \times 28 + \frac{22}{7} \times 14$ $= 22\text{cm} + 44\text{cm}$ $= 66\text{cm}$ $66\text{cm} + 18\text{cm} = 84\text{cm}$ Total perimeter = $84\text{cm} \times 3 = 252\text{cm}$
Q15)	$\frac{3}{4} \text{ bead} = \frac{1}{3} \text{ pearl}$ $\frac{9}{12} \text{ bead} = \frac{4}{12} \text{ pearl}$ $\frac{1}{3} = \frac{4}{12}, \frac{1}{4} = \frac{3}{12}$ $13u = 754$ $1u = 58$ left = 4u $= 4 \times 58$ $= 232$
Q16)	2 : 3 20 : 30

	$(4 \times 5) : (5 \times 6)$ $(\$1.99 \times 5) + (\$2.99 \times 6) = \$27.89$ $\$139.45 \div \$27.89 = 5 \text{ sets}$ $\text{No of pencils} = (5 \times 6) \times 5$ $= 150 \text{ pencils}$
Q17 - a)	$\text{Bag} = \frac{5}{6} \times \frac{3}{8}$ $= \frac{5}{16}$
b)	$20nb + \$40 = 2nb + \76 $18nb = \$36$ $1nb = \$2$ $10nb + 10f = (\$2 \times 10) + (\$6 \times 10)$ $= \$80$ $\text{Bag} = \$40$ $5u = \$40$ $1u = \$8$ $16u = \$128$ $\$80 + \$40 = \$120$ $\$128 - \$120 = \$8$