

Name: _____

Class: Primary 6 _____

CHIJ ST NICHOLAS GIRLS' SCHOOL (PRIMARY)



Primary 6 Mathematics

2025 Preliminary Examination

Paper 1

Booklet A

22 August 2025

15 questions

20 marks

Total Time for Booklets A and B: 1 hour

INSTRUCTIONS TO CANDIDATES

Do not turn over this page until you are told to do so.

Follow all instructions carefully.

Answer all questions.

Write your answers in this booklet.

The use of calculators is **NOT** allowed.

This booklet consists of 9 printed pages.

Questions 1 to 10 carry 1 mark each. Questions 11 to 15 carry 2 marks each. For each question, four options are given. One of them is the correct answer. Make your choice (1, 2, 3 or 4). Shade the correct oval (1, 2, 3, or 4) on the Optical Answer Sheet.

(20 marks)

1. What is fifty-two thousand and forty-three in numerals?

- (1) 5243
- (2) 52 043
- (3) 520 043
- (4) 520 430

2. Which one of the following fractions is smaller than $\frac{3}{8}$?

- (1) $\frac{1}{2}$
- (2) $\frac{2}{7}$
- (3) $\frac{5}{9}$
- (4) $\frac{5}{12}$

3. Rosy had 300 buttons. She used 45 buttons for her project.
What percentage of her buttons did she use for her project?

- (1) 85%
- (2) 55%
- (3) 45%
- (4) 15%

4. STUV is a square. Find $\angle WTU$.

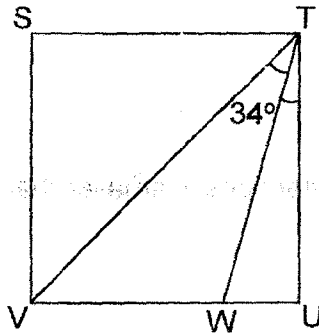

- (1) 11°
- (2) 28°
- (3) 45°
- (4) 56°

5. ABCD is a rectangle. Find $\angle x$.

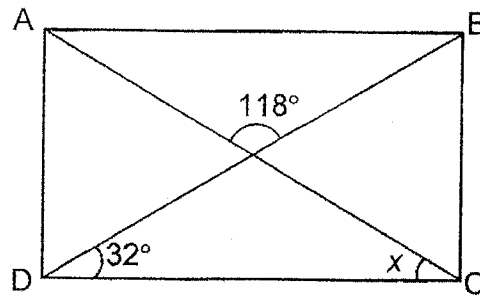

- (1) 30°
 (2) 32°
 (3) 62°
 (4) 86°

6. Arrange these distances from the shortest to the longest.

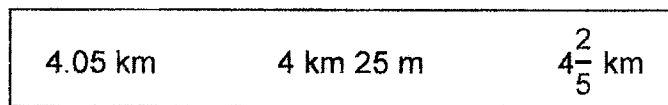

- | | <u>Shortest</u> | | <u>Longest</u> |
|-----|-------------------|---|-------------------|
| (1) | 4.05 km | , | $4\frac{2}{5}$ km |
| | | , | 4 km 25 m |
| (2) | 4 km 25 m | , | 4.05 km |
| | | , | $4\frac{2}{5}$ km |
| (3) | 4 km 25 m | , | $4\frac{2}{5}$ km |
| | | , | 4.05 km |
| (4) | $4\frac{2}{5}$ km | , | 4 km 25 m |
| | | , | 4.05 km |

7. Clifford went trekking from 6.55 a.m. to 4.10 p.m. yesterday. How long did he trek?

- (1) 8 h 15 min
- (2) 9 h 15 min
- (3) 9 h 45 min
- (4) 10 h 15 min

8. Which two shapes shown in the grid have the same area?

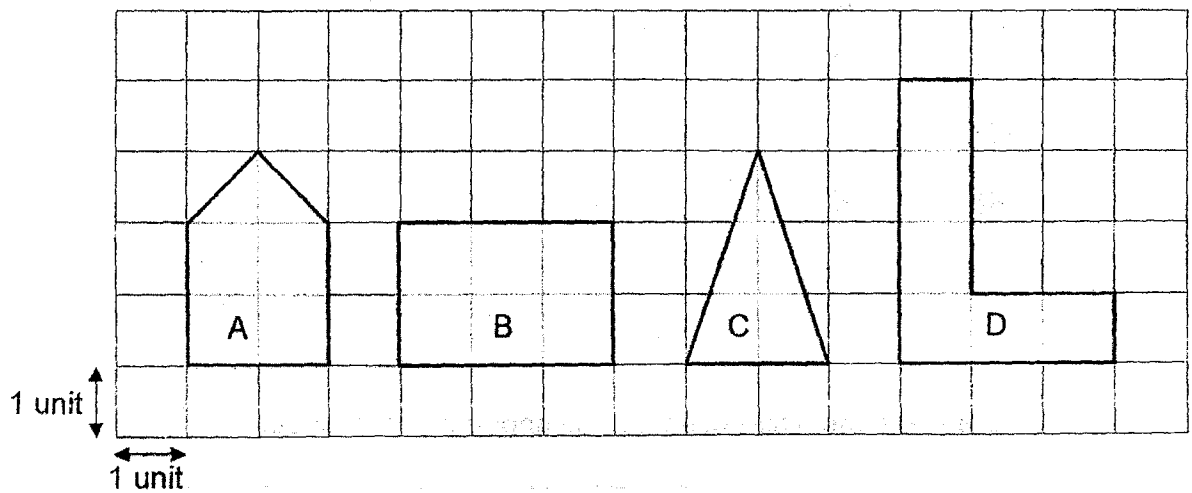

- (1) A and C
- (2) A and D
- (3) B and C
- (4) B and D

Use the information below to answer Question 9 and 10.

The table shows the number of green and orange beads packed into 4 boxes by Cassie.

Box	Green	Orange	Total
A	11	15	26
B	21	21	42
C	21	23	44
D	18	14	32

9. Which box has more green beads than orange beads?

- (1) A
- (2) B
- (3) C
- (4) D

10. How many more green beads does Cassie need to pack into Box C so that the number of green beads in Box C is 17 more than the total number of beads in Box D?

- (1) 21
- (2) 28
- (3) 49
- (4) 53

11. The pie chart shows the number of children at a drama workshop over 4 days. 50 children were there on Saturday. How many children were at the drama workshop on Thursday?

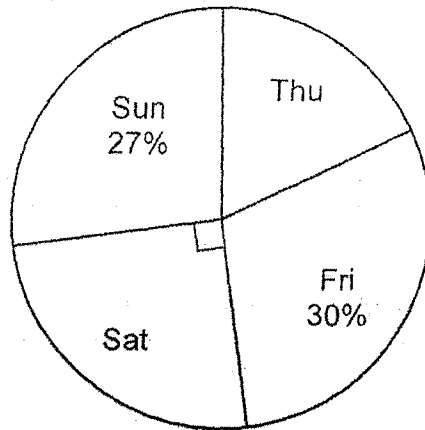

- (1) 82
 (2) 40
 (3) 36
 (4) 18
12. The outline of the shaded figure is formed by 2 identical small semicircles and 2 identical large semicircles. The radius of the small semicircle is 3 cm. Find the perimeter of the shaded parts. (Take $\pi = 3.14$)

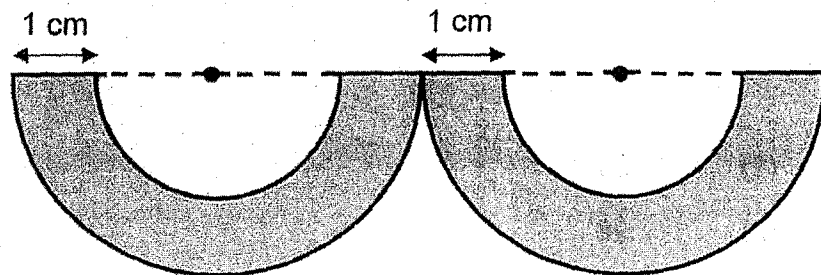

- (1) 43.96 cm
 (2) 47.96 cm
 (3) 55.96 cm
 (4) 59.96 cm

13. In the figure, ADEG is a parallelogram and FHJ is a triangle. GJ is a straight line. AG is parallel to BF. Find $\angle m$.

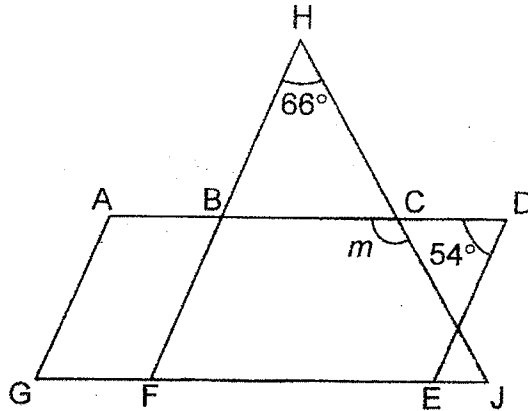

- (1) 120°
 (2) 123°
 (3) 126°
 (4) 127°
14. Freddy had \$250 and Karina had \$100 at first. After both of them spent an equal amount of money on a present, the amount of Freddy's money left was $\frac{7}{2}$ of the amount of Karina's money left. How much money did Freddy have left?

- (1) \$220
 (2) \$210
 (3) \$80
 (4) \$60

15. George packed 84 pears and 96 mangoes into as many bags as possible with no fruits left unpacked. He packed the same number of fruits in each bag. The number of each type of fruit in each bag was the same. How many bags of fruits did George pack?

- (1) 7
- (2) 8
- (3) 12
- (4) 15

Name: _____ ()

Class: Primary 6 _____

CHIJ ST NICHOLAS GIRLS' SCHOOL (PRIMARY)

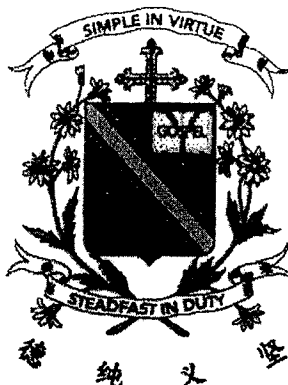

**Primary 6 Mathematics
2025 Preliminary Examination**

Paper 1

Booklet B

22 August 2025

**15 questions
25 marks**

Booklet A	20
Booklet B	25
Total (Paper 1)	45

Total Time for Booklets A and B: 1 hour

INSTRUCTIONS TO CANDIDATES

Do not turn over this page until you are told to do so.

Follow all instructions carefully.

Answer all questions.

Write your answers in this booklet.

The use of calculators is **NOT** allowed.

This booklet consists of 12 printed pages.

Questions 16 to 20 carry 1 mark each. Show your working clearly and write your answers in the spaces provided. For questions which require units, give your answers in the units stated. (5 marks)

Do not write in this space

16. Round 17.445 to the nearest tenth.

Ans: _____

17. Find the value of $\frac{6}{7} \div 15$. Give your answer as a fraction in the simplest form.

Ans: _____

--

18. Desmond used pink stars and green stars to decorate a photo frame for his mother. For every 5 pink stars Desmond used, he used 4 green stars. Desmond used a total of 72 stars. How many green stars did Desmond use for the photo frame?

Do not
write
in this
space

Ans: _____

19. The total mass of 6 pails is 6.54 kg. Each pail has the same mass. What is the mass of 9 such pails?

Ans: _____ 9

20. — The graph shows the number of children in the families living in Happy Estate.

Do not
write
in this
space

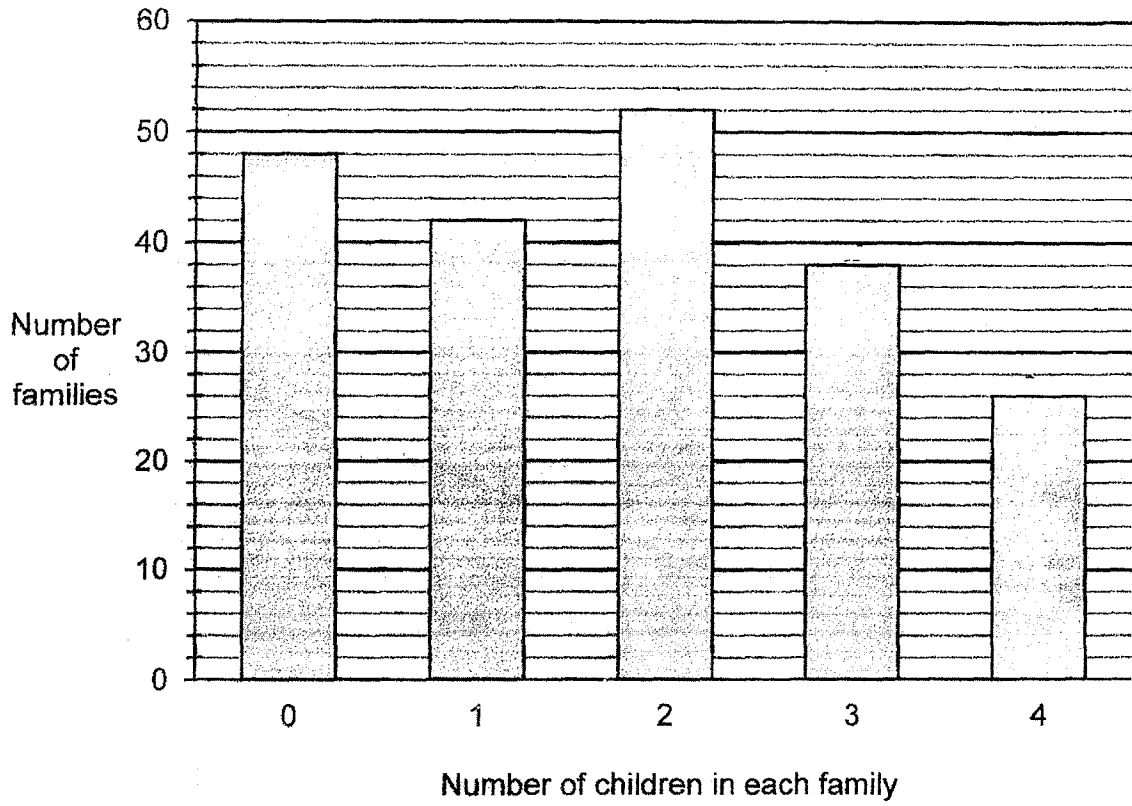

How many families have at least 2 children?

Ans: _____

Questions 21 to 30 carry 2 marks each. Show your working clearly and write your answers in the spaces provided. For questions which require units, give your answers in the units stated. (20 marks)

Do not write in this space

Use the information below to answer Question 21 and 22.

The line graph shows the number of vases sold in a shop over three months.

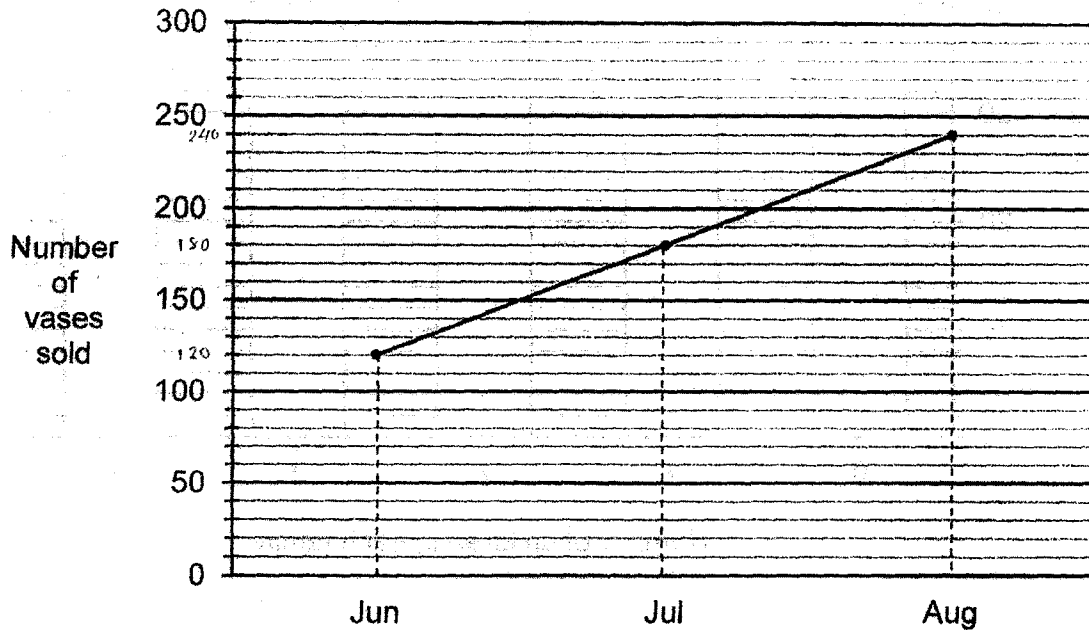

21. The average number of vases sold from June to September was 190. How many vases were sold in September?

Ans: _____

22. The average number of vases sold in October and November was 18 more than the average number of vases sold from June to September. Find the total number of vases sold in October and November.

Ans: _____

23. Lina bought 3 packets of stickers. Each packet contained y stickers. She kept 3 stickers for herself and gave the rest of the stickers equally to her 6 friends.

Do not
write
in this
space

(a) How many stickers did each friend receive in terms of y ?

Ans: (a) _____

(b) Each friend received 8 stickers from Lina. Find the value of y .

Ans: (b) _____

24. The square grid shows the positions of Points A, B, C, D, E and F.

Do not
write
in this
space

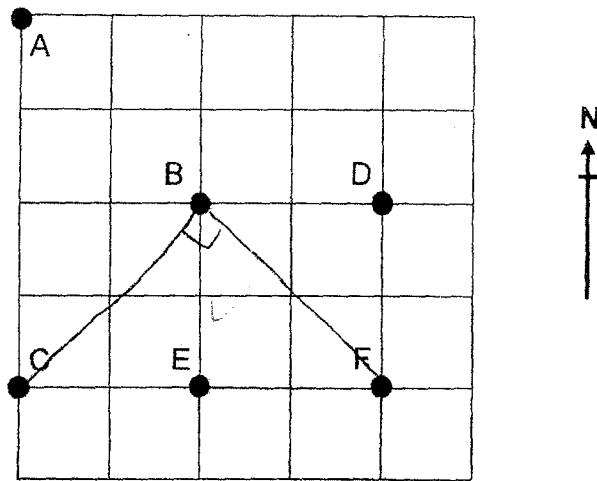

- (a) Ramsy walked directly from point E to point D in a straight line.
In which direction did Ramsy walk?

Ans: (a) _____

- (b) Pan Ling stood at point B at first. After she turned 90° anti-clockwise,
she faced F. Which point was Pan Ling facing at first?

Ans: (b) Point _____

25. In the figure, AOB is a straight line. $\angle AOC = 201^\circ$ and $\angle COD = 264^\circ$.
Find $\angle AOD$.

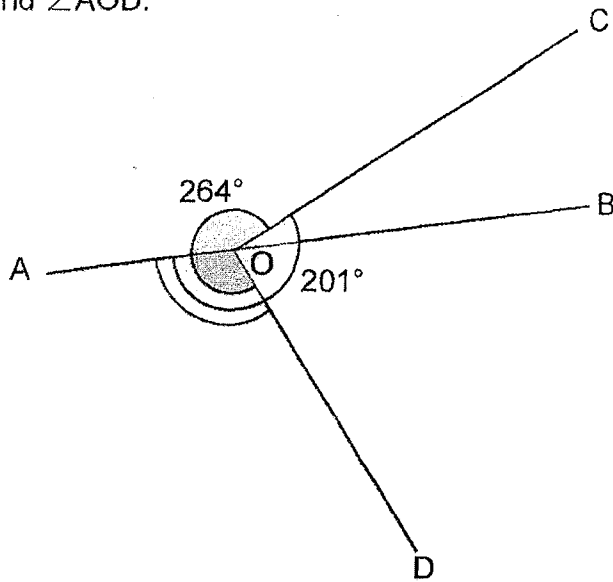

Do not
write
in this
space

Ans: _____

26. (a) Which 2 views of the solid are the same?

Do not write in this space

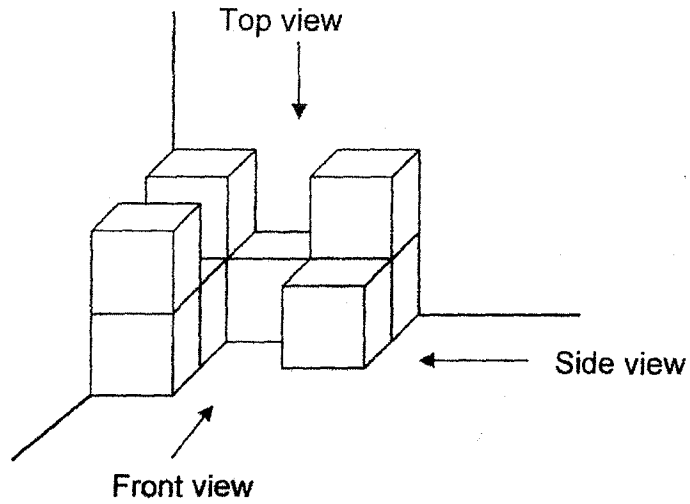

Ans: _____ view and _____ view

(b) The four shaded squares form part of the net of a cube.
Draw 2 more squares to complete the net of a cube.

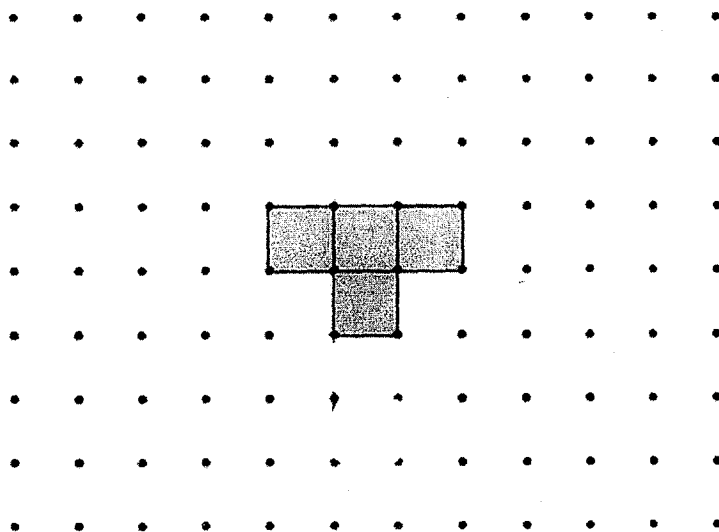

27. Aloysius travelled from Town J to Town K. He travelled at an average speed of 60 km/h for a total distance of 150 km. He reached Town K at 6 p.m. What time did Aloysius leave Town J?

Do not write in this space

Ans: _____ p.m.

28. A cuboid and a cube are joined together to form a rectangular block as shown. The length of the cube is 3 cm. The volume of the cuboid is 5 times the volume of the cube. What is the volume of the rectangular block?

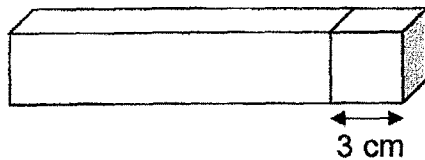

Ans: _____ cm^3

29. This figure is made up of 6 identical squares, a semicircle and an equilateral triangle. Find the perimeter of the figure. Leave your answer in terms of π .

Do not write in this space

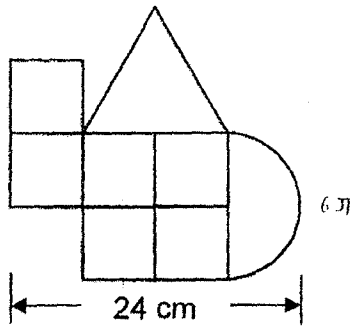

Ans: _____ cm

30. Alizah baked some cupcakes. She gave $\frac{1}{6}$ of the cupcakes to her siblings and $\frac{1}{4}$ of the cupcakes to her classmates. She sold $\frac{1}{2}$ of the remaining cupcakes.

At the end of the day, she was left with 49 cupcakes. How many cupcakes did Alizah give to her siblings?

Do not
write
in this
space

Ans: _____

Name: _____ ()

Class: Primary 6 _____

CHIJ ST NICHOLAS GIRLS' SCHOOL (PRIMARY)

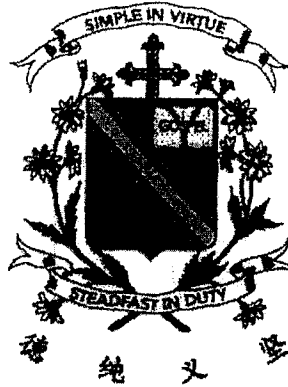

Primary 6 Mathematics

2025 Preliminary Examination

Paper 2

22 August 2025

Paper 1	45
Paper 2	55
Total Marks	100

Parent's/Guardian's Signature

Time : 1 hour 30 minutes

INSTRUCTIONS TO CANDIDATES

Do not turn over this page until you are told to do so.

Follow all instructions carefully.

Answer all questions.

Write your answers in this booklet

The use of an approved calculator is expected, where appropriate.

This bookle

printed pages.

Questions 1 to 5 carry 2 marks each. Show your working clearly and write your answers in the spaces provided. For questions which require units, give your answers in the units stated. (10 marks)

Do not write in this space

1. The figure shows the amount of water in the bottles and jug at first.

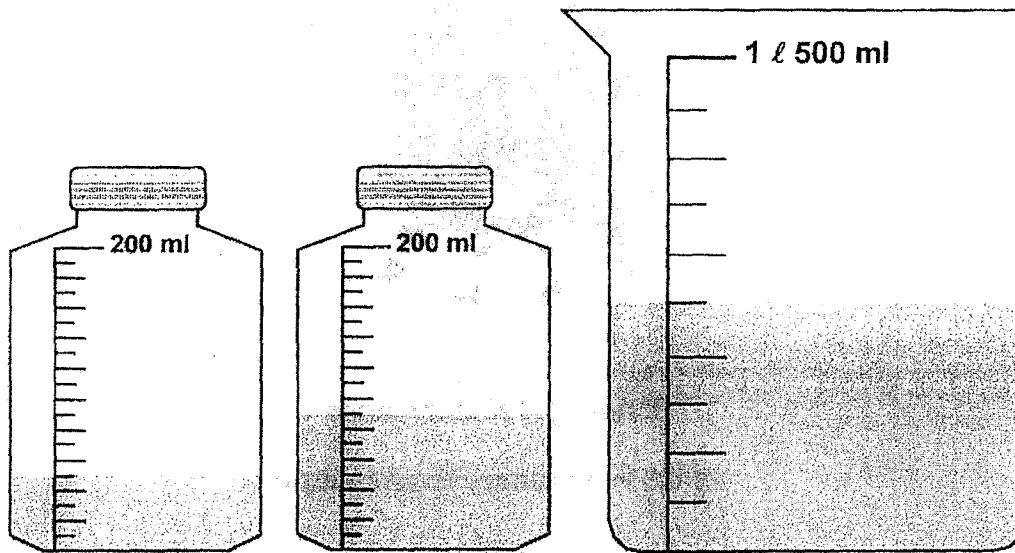

All the water in the bottles was poured into the jug without any spilling over.
What would be the volume of the water in the jug in the end?

Ans : _____ l

2. ABCD is a rhombus and BEFD is a rectangle. $\angle BCD = 68^\circ$. Find $\angle ADF$.

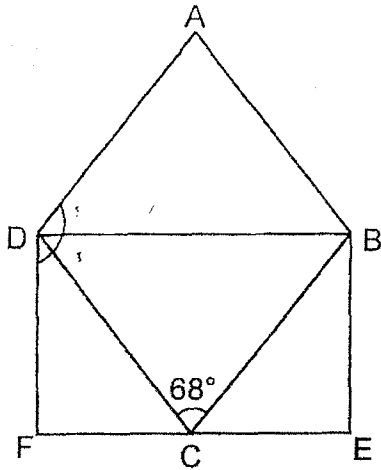

Do not
write
in this
space

Ans : _____ °

3. At first, the cans in a shop were placed on 60 shelves with an equal number of cans on each shelf. 6 shelves were removed and the cans on these shelves were placed on the remaining 54 shelves. The number of cans on each remaining shelf was 40. How many cans were removed from the 6 shelves?



4. Benson had three fewer \$1 coins than 20¢ coins. He used all his \$1 coins and two 20¢ coins. The total value of the 20¢ coins left was \$2. How much money did Benson use?

Do not write in this space

Ans : \$ _____

5. Melvin is given a card with 9 numbers. The number 89 is circled. He has to circle 2 more numbers so that the average of the 3 circled numbers is the same as the average of the 9 numbers on the card. Which 2 numbers does Melvin have to circle?

81	88	34
36	53	70
89	75	86

Ans : _____ and _____

For questions 6 to 17, show your working clearly and write your answers in the spaces provided. The number of marks available is shown in the brackets () at the end of each question or part-question. (45 marks)

Do not write in this space

6. In a shop, cups are sold in sets of 8 and plates are sold in sets of 12.

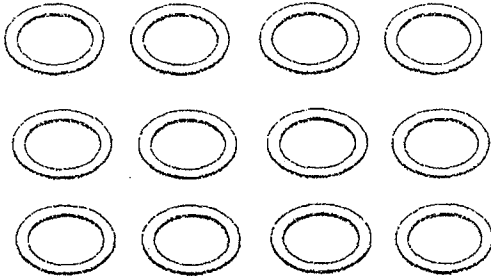
	
8 cups for \$60	12 plates for \$75

Lim Soon bought the same number of cups and plates.

He spent \$660 altogether. How many cups did Lim Soon buy?

Ans : _____ [3]

7. The figure is made up of 2 identical parallelograms, ABDH and HDEG and a triangle, EFG. AC and DF are straight lines.

Do not write in this space

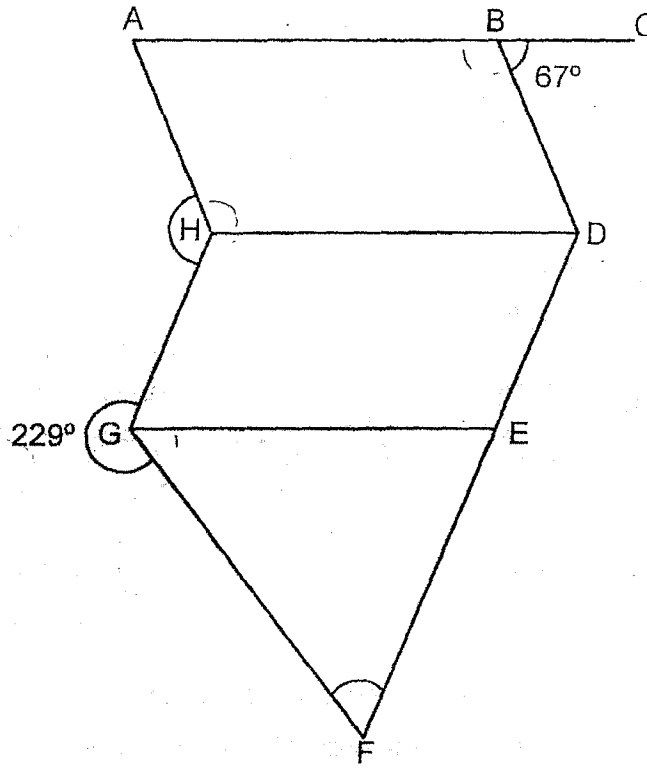

- (a) Find $\angle AHG$.

Ans : (a) _____ [1]

- (b) Find $\angle EFG$.

Ans : (b) _____ [2]

8. The table shows the number of curry puffs sold at a shop last week.

Day	Number of curry puffs sold
Monday to Friday	$2w$ per day
Saturday	$w + 40$
Sunday	$9w - 5$

Do not
write
in this
space

- (a) How many curry puffs were sold altogether last week?
Express your answer in terms of w in the simplest form.

Ans : (a) _____ [1]

- (b) Each statement below is either true, false or not possible to tell from the information given. For each statement, put a tick (\checkmark) to indicate your answer.

Statement	True	False	Not possible to tell
More curry puffs were sold on Saturday than on Monday.			
Each curry puff cost \$2. The amount of money collected on Monday was \$ $4w$.			

[2]

9. The table shows how much an electrical company charges for electricity. The charges are before GST.

Usage	Charges
First 180 units	\$0.25 per unit
Any usage above 180 units	\$0.35 per unit

- (a) In January, the Wang family used 260 units of electricity. How much did the Wang family pay for their usage after including a 9% GST?

Ans : (a) _____ [2]

- (b) In February, the charges of electricity for the Wang family was \$60.05 before GST. How many units of electricity did the Wang family use in February?

Ans : (b) _____ [1]

Do not
write
in this
space

10. X and Y are two rectangular tanks. At first, X was filled with some water and Y was empty. The base area of Y is 135 cm^2 . Some water was poured from X to Y without spilling. In the end, the amount of water in Y was 2430 cm^3 . The height of water in X was $\frac{3}{4}$ the height of water in Y. The amount of water then left in X was $\frac{2}{3}$ the amount of water in Y. What is the base area of X?

Do not write in this space

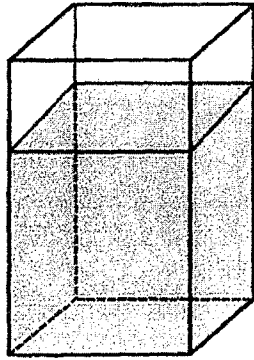

X

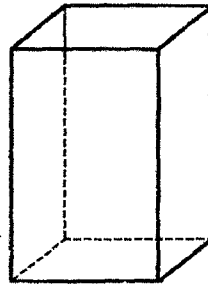

Y

Ans: _____ [3]



11. A file cost \$3.10 more than a pen. Hakim bought twice as many pens as files. He spent a total of \$92.70. He spent \$6.30 more on the files than on the pens. Find the total cost of a pen and a file.

Do not write in this space

Ans: _____ [3]



12. A fitness club had 280 members in 2023. 40% of the members were females and the rest were males. In 2024, the number of male members increased by 37.5% and the female members dropped to 84 members.

Do not
write
in this
space

- (a) Find the percentage decrease in the number of female members from 2023 to 2024.

Ans : (a) _____ [2]

- (b) What was the total number of members in the fitness club in 2024?

Ans : (b) _____ [2]

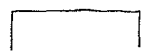

13. At first, $\frac{3}{8}$ of a fish tank was filled with water. A tap was turned on for more water to flow into the tank. It was then turned off after 25 minutes. The line graph shows the amount of water in the tank over the 25 minutes.

Do not write in this space

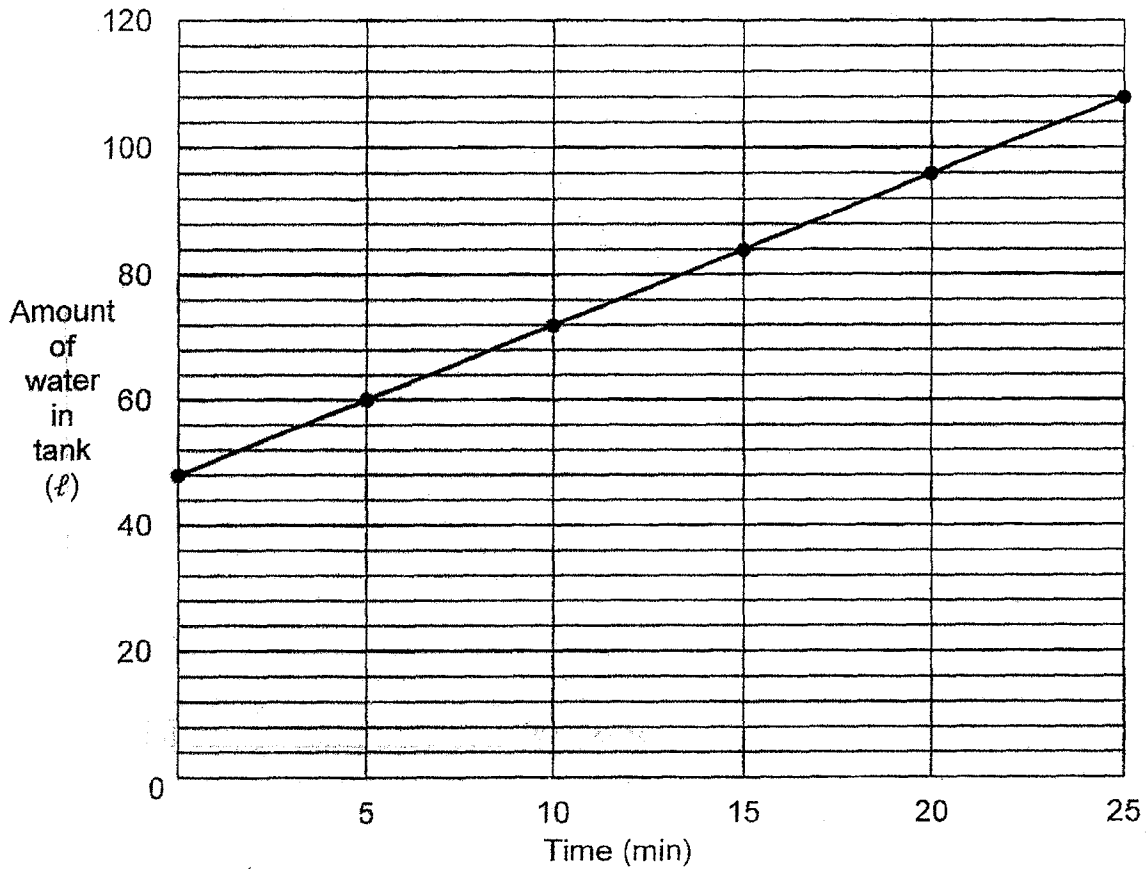

- (a) How many litres of water flowed into the tank in one minute?

Ans : (a) _____ [1]

- (b) At the end of 25 minutes, what fraction of the tank was not filled with water?

Do not
write
in this
space

Ans : (b) _____ [2]

- (c) The tap was turned on again at the same rate as before. How many more minutes did it take to fill the tank completely?

Ans : (c) _____ [1]

14.

Greatest Sales Ever!



Buy first book at
10% discount

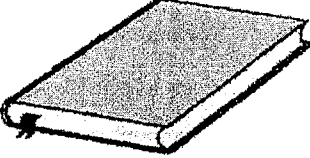

Buy second book at
% discount

Price of second book should be equal to or lower than the price of first book.

Do not write in this space

Suzy bought two books at the sale as shown in the brochure as shown above. She accidentally spilled some ink on the brochure. The percentage discount given for the second book was smudged.

- (a) Suzy paid \$21.05 for the two books. She paid \$1.45 less for the second book than the first book. How much did she pay for the first book?

Ans : (a) _____ [1]

(b) Find the original price of the first book.

Do not
write
in this
space

Ans : (b) _____ [1]

(c) Suzy saved a total of \$3.70. Find the percentage discount for the second book.

Ans : (c) _____ [2]



15. In the grid, AB and BC are straight lines.

(a) Measure and write down the size of $\angle ABC$.

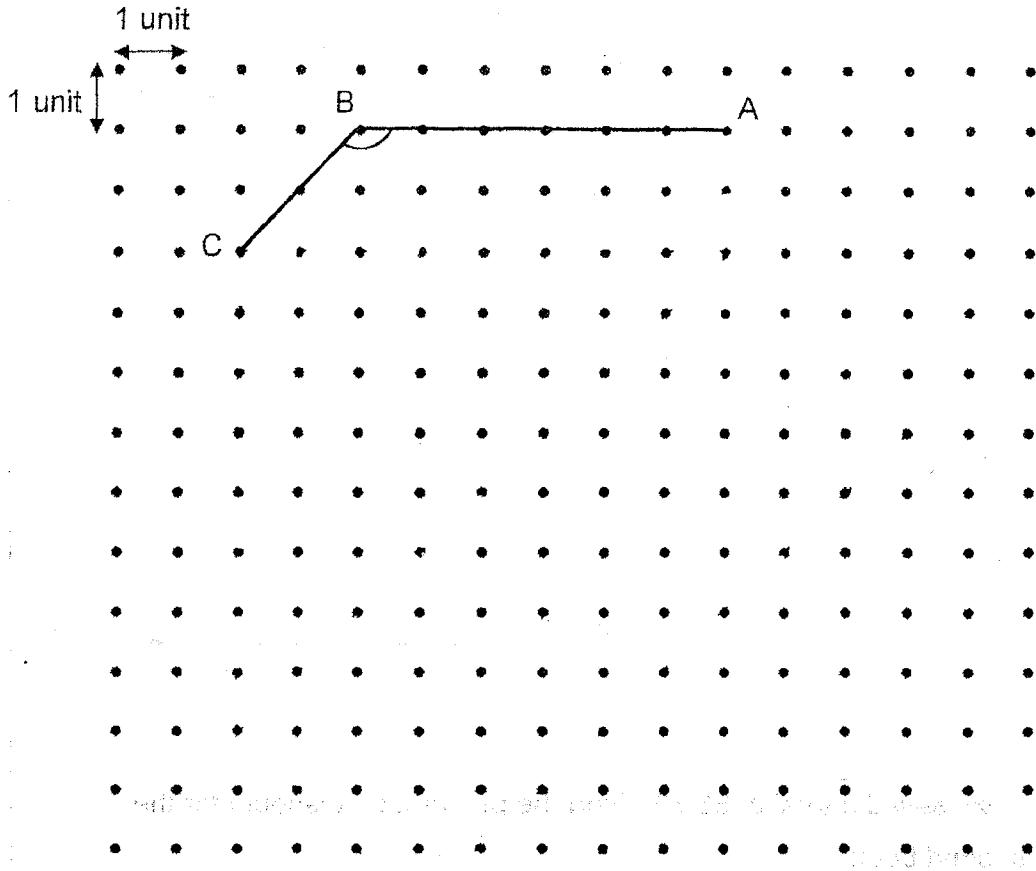

Do not write in this space

F Ans : (a) _____ [1]

(b) AB and BC are two sides of a trapezium ABCD. BA is parallel to CD. CD is 2 units longer than BA. Complete the drawing of trapezium ABCD.

[1]

(c) CD is also one of the sides of an isosceles triangle CDE. $CD = DE$.

Draw triangle CDE.

[1]

(d) Draw rectangle DEFG such that it has the same area as triangle CDE.

Rectangle DEFG must not overlap with trapezium ABCD and triangle CDE.

[2]

Use a pencil to draw your diagrams and label them clearly.

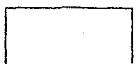

16. Paul and Zalim went out together with a total of \$140.20. Zalim spent 4 times as much money as Paul. The amount of money Paul had left was \$12 more than $\frac{1}{2}$ of what Zalim spent. The amount of money Zalim had left was $\frac{1}{5}$ of what Paul had left.

Do not
write
in this
space

(a) How much money did Paul spend?

Ans : (a) _____ [3]

(b) How much money did Zalim have at first?

Ans : (b) _____ [2]

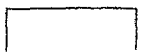

17. A footpath of length 25.2 m is tiled using identical rectangular tiles and identical circular tiles, following the pattern below. Each tile is in contact with those next to it. The width of the footpath is 84 cm. (Take $\pi = \frac{22}{7}$)

Do not write in this space

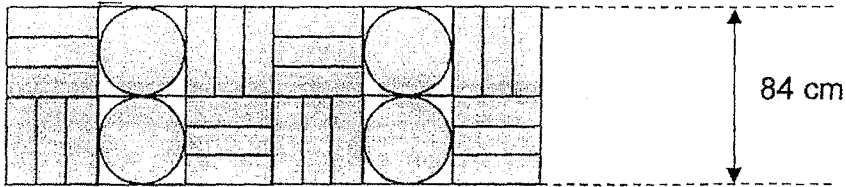

- (a) How many rectangular and circular tiles were used to tile the entire footpath altogether?

Ans: (a) _____ [1]



(b) Find the area of the footpath not covered by tiles.

Do not
write
in this
space

Ans: (b) _____ [3]

(c) All the tiles on the footpath need to be replaced. The cost to replace each type of tile is as shown in the table.

Type of tile	Cost per tile
Circular tile	\$3.20
Rectangular tile	\$1.80

What is the total cost to replace all the tiles on the footpath?

Ans: (c) _____ [1]

SCHOOL : CHIJ ST NICHOLAS GIRLS' PRIMARY SCHOOL
LEVEL : PRIMARY 6
SUBJECT : MATHEMATICS
TERM : PRELIMINARY EXAMINATION

Q1	Q2	Q3	Q4	Q5	Q6	Q7	Q8	Q9	Q10
2	2	4	1	1	2	2	4	4	2
Q11	Q12	Q13	Q14	Q15					
3	2	1	2	3					

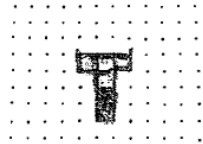
16	17.445 \approx 17.4	17	$\frac{6}{7} \div 15 = \frac{6}{7} \times \frac{1}{15} = \frac{6}{105} = \frac{2}{35}$
18	5 + 4 = 9 72 \div 9 = 8 8 \times 4 = 32	19	9.81 \times 1000 = 9810g
20	10 \div 5 = 2 52 + 38 + 26 = 90 + 26 = 116	21	190 \times 4 = 760 120 + 180 + 240 = 540 760 - 540 = 220
22	190 + 18 = 208 208 \times 2 = 416	23	a) 3 \times y = 3y (3y - 3) \div 6 = $\frac{3y-3}{6}$ b) 8 \times 6 = 48 48 + 3 = 51 51 \div 3 = 17
24	a) North-East b) C	25	360 $^\circ$ - 264 $^\circ$ = 96 $^\circ$ 201 $^\circ$ - 96 $^\circ$ = 105 $^\circ$
26	a) Front view and side view b) 	27	$\frac{150}{60} = \frac{15}{6} = 2\frac{1}{2}$ ANS: 3:30 pm
28	3 \times 3 \times 3 = 27 27 \times 5 = 135 135 + 27 = 162 cm ³	29	24 \div 4 = 6 6 \times 2 = 12 $\frac{1}{2} \times \pi \times 12 = 6\pi$ 6 \times 12 = 72 ANS: (6 π + 72) cm

30	$\frac{7}{12} \rightarrow 49 \times 2 = 98$ $\frac{1}{12} \rightarrow 98 \div 7 = 14$ $\frac{2}{12} \rightarrow 14 \times 2 = 28$		
----	---	--	--

Paper 2

1	$200 \div 20 = 10$ $10 \times 5 = 50$ $10 \times 9 = 90$ $90 + 50 = 140$ $1500 \div 10 = 150$ $150 \times 5 = 750$ $750 + 140 = 890$ ANS: 0.890λ	2	$180 - 68 = 112^\circ$ $112 \div 2 = 56^\circ$ $90 + 56 = 146^\circ$
3	$54 \times 40 = 2160$ $2160 \div 60 = 36$ $36 \times 6 = 216$	4	$2 \div 0.2 = 10$ $10 + 2 = 12$ $12 - 3 = 9$ $9 \times 1 + (2 \times 0.2) = \9.40
5	$81 + 88 + 34 + 36 + 53 + 70 + 89$ $+ 75 + 86 = 612$ $612 \div 9 = 68$ $68 \times 3 = 204$ $204 - 89 = 115$ ANS: 81 and 34	6	$6 \times 60 = 360$ $75 \times 4 = 300$ $360 + 300 = 660$ Ans: 48
7	a) $180^\circ - 67^\circ = 113^\circ$ $113^\circ \times 2 = 226^\circ$ $360^\circ - 226^\circ = 134^\circ$ b) $229^\circ + 67^\circ = 296^\circ$ Angle EGF = $360^\circ - 296^\circ = 64^\circ$ Angle GEF = $180^\circ - 113^\circ = 67^\circ$ $180^\circ - 64^\circ - 67^\circ = 49^\circ$	8	a) $2w \times 5 = 10w$ $10w + w + 40 = 11w + 40$ $11w + 40 + 9w + 35$ ANS: $20w + 35$ b) - Not possible to tell - True
9	a) $180 \times 0.25 = 45$ $260 - 180 = 80$ $80 \times 0.65 = 23$ $45 + 28 = 73$ $\frac{9}{100} \times 73 = 6.57$ $73 \div 6.57 = 79.57$ b) $180 \times 0.25 = 45$ $60.05 - 45 = 15.05$ $15.05 \div 0.35 = 43$ $180 + 43 = 223$	10	Height of water in Y $2430 \div 135 = 18$ Height of water in X $\frac{3}{4} \times 18 = 13.5$ X water volume: $\frac{2}{3} \times 2430 = 1620 \text{ cm}^3$ $1620 \div 13.5 = 120 \text{ cm}^2$
11	$92.70 - 6.30 = 86.40$ $86.40 \div 2 = 43.20$ $43.20 + 6.30 = 49.50$	12	a) Female $\rightarrow \frac{40}{100} \times 280 = 112$ Drop $\rightarrow 112 - 84 = 28$

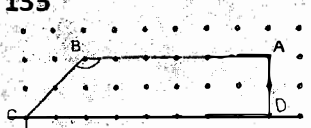
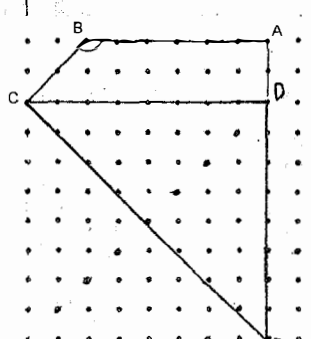
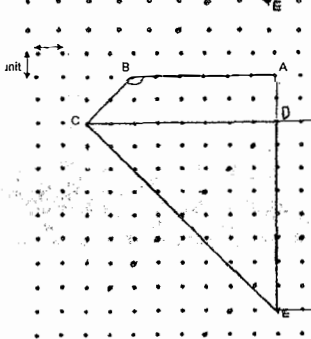
	$43.20 \div 2 = 21.60$ $49.50 - 21.60 = 27.90$ $27.90 - 3.10 = 9$ $49.50 + 21.60 = 71.10$ $71.10 \div 9 = \$7.90$		$\frac{28}{112} \times 100\% = 25\%$ b) 2023 males $\rightarrow 280 - 112 = 168$ $\frac{37.5}{100} \times 168 = 63$ $168 + 63 + 84 = 315$
Q13	a) $60 - 48 = 12$ $12 \div 5 = 2.4L$ b) $\frac{3}{8} \rightarrow 48L$ $\frac{1}{8} \rightarrow 48 \div 3 = 16L$ $\frac{8}{8} \rightarrow 16 \times 8 = 128L$ $128 - 108 = 20$ $\frac{20}{128} = \frac{5}{32}$ c) $20 \div 2.4 = 8\frac{1}{3} \text{ min}$	Q14	a) $21.05 - 1.45 = 19.60$ $19.60 \div 2 = 9.80$ $9.80 + 1.45 = \$11.25$ b) $90\% \rightarrow 11.25$ $10\% \rightarrow 11.25 \div 9 = 1.25$ $100\% \rightarrow 1.25 \times 10 = 12.50$ c) $\$3.70 - \$1.25 = \$2.45$ $\$9.80 + 2.45 = 12.25$ $\frac{2.45}{12.25} \times 100\% = 20\%$
Q15	a) 135°  b)  c)  d)	Q16	a) $37 \text{ units} + \$12 + \$2.40 = \$140.20$ $37 \text{ units} = 14.20 - 12 - 2.40 = 125.80$ $1 \text{ units} = 125.80 \div 37 = 3.4$ $5 \text{ unit} = 3.4 \times 5 = \17 b) Zalim $\rightarrow 22 \text{ units} + 2.40$ $22 \times 3.4 + 2.40 = \$77.20$
Q17	a) $25.2m = 25.2 \times 100cm = 2520$ $84 \div 2 = 42$ $42 \times 3 = 126$ $2520 \div 126 = 20$ $20 \times (6+1) = 140$ $140 \times 2 = 280$ b) $20 \times 2 = 40$ $42 \times 42 = 1764$		

	$\frac{22}{7} \times 21 \times 21 = 1386$ $1764 - 1386 = 378$ $378 \times 40 = 15120 \text{cm}^2$		
c)	$40 \times 6 = 240$ $280 - 40 = 240$ $240 \times 1.80 = 432$ $40 \times 3.2 = 128$ $432 + 128 = \$560$		

4

END